

# Plymouth Fury



THE ROARING '65s / FURY / BELVEDERE / VALIANT / BARRACUDA *Plymouth*

# Sport Fury / Fury III / Fury II / Fury I

Big. Plush. Zoomy. These are only a few of the words that almost describe the look and feel and performance of the new 1965 Plymouth Fury.

From the top of the line—the Sport Fury—to this year's *longest* nine-passenger, passenger-pampering Fury Station Wagon, there are 22 models in all. A baker's dozen of colors *plus* black and white. Five get-up-and-go engines, ranging from a standard 225-cu.-in. "economy 6" to a 426-cu.-in. optional Commando V-8.

Startling new options include an *adjustable* steering wheel...an Auto-Pilot...and an electrically operated door-locking system.

You can shift into high with a 3-speed manual transmission, an optional 3-speed automatic (selector lever mounted on steering wheel column), or an optional "4-on-the-floor" stick shift with Hurst linkage.

Longer and wider than 1964 models, the 1965 Plymouth Fury has a 119-inch wheelbase (Fury Wagons 121-in.). Increased headroom and legroom add to seating comfort. Curved side glass is featured for the

first time by Plymouth for a distinctive continuity of surface lines as sheet metal and windows blend together. Visibility is noticeably increased in all directions.

Plymouth has learned a lot about performance—on the test track, in open competition on racetracks and drag strips, on open country highways and busy city streets. The results are built into this

year's Plymouth Furys (and all 60 of "The Roaring '65s": Fury, Belvedere, Valiant and Barracuda) as never before. Substantial improvements also have been made in comfort and convenience, in such big things as a *new* unitized body, in little touches such as parallel-

operating (electric) windshield

wipers and crank-operated vent windows. Obviously prejudiced, our enthusiasm probably shows on nearly every page of this brochure as we list new features, improvements, extra-cost options and the like. Your enthusiasm will show, too, as you take your first test drive. Then you'll have a problem: *which* Plymouth Fury to take home? Delightful dilemma.

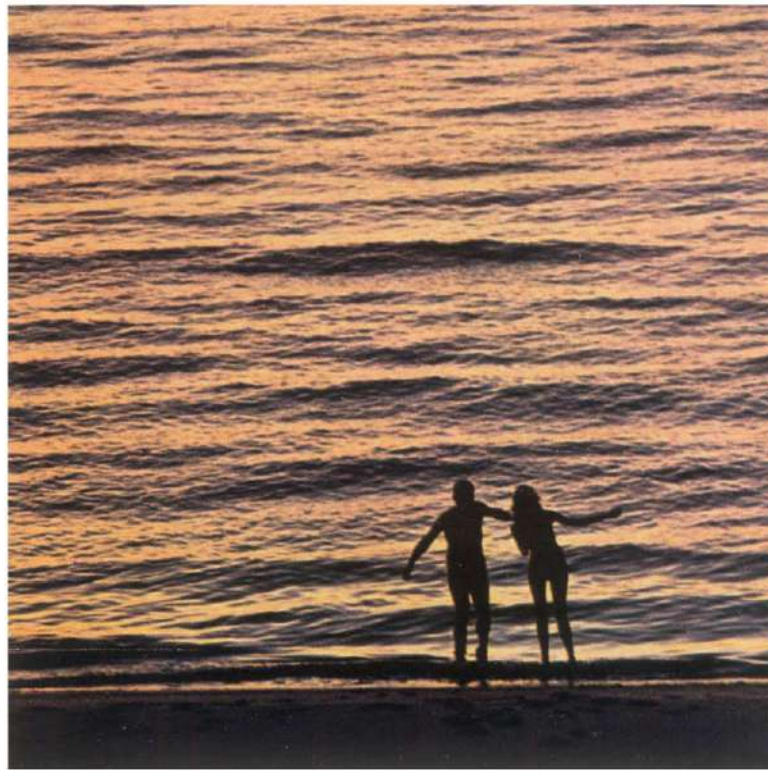

# Sport Fury

Zero in on performance, inside-and-out style and a feel of luxury that lets you know this is *your* car. Take a trial spin down the road and snuggle back in bucket-seat comfort as you go. Wander off on a bumpy side road and see how little difference it makes to your riding pleasure. Back in town, be a little modest as you get admiring glances from those who haven't driven the '65 Sport Fury yet. **Standard features on the '65 Sport Fury include:** 318-cu.-in. V-8 engine, 3-speed manual transmission, all-vinyl individual front bucket seats, compartment console, torsion-bar suspension, Oriflow shock absorbers, custom wheel

covers with spinner hubs, removable rear fender skirts and a heater/defroster. *You also get* self-adjusting brakes, deep-pile formed carpeting, electric windshield wipers, electric clock, front and rear armrests with ash receivers in rear, dual tail-lights, back-up lights, parking brake warning light, glove box light and luggage compartment light. *And* sun visors (right and left), a cigar lighter, front seat belts, deluxe steering wheel with full horn ring, electrically operated top on convertibles, and alternator.

**Popular options and accessories:** 3-speed TorqueFlite transmission with

console-mounted selector, and a 383- (2- or 4-bbl.) or 426-cu.-in. Commando V-8 engine; power steering and brakes, power seats and windows; "4-on-the-floor" transmission with Hurst linkage and console-mounted shift lever, Sure-Grip differential, remote-control side-view mirror, day/nite mirror, padded instrument panel, Transaudio AM or AM-FM radio, undercoating. *You may also choose* an adjustable steering wheel, Auto-Pilot, console-mounted tachometer, rear window defogger and 4-way power-operated bucket seats. (See page 20 for additional options and accessories.)

**Basic specifications (2-door hardtop)**

Overall length—209.4 in.

Overall width—78.0 in.

Overall height—54.9 in.

Wheelbase—119.0 in.

Trunk capacity—16.8 cu. ft.

(Additional specifications on page 22.)



*Sport Fury 2-door Hardtop/ruby with black vinyl-covered roof*



Luxury comes in standard and optional form inside a Sport Fury Convertible. Transaudio AM radio is an extra-cost option, as are power windows, tachometer,

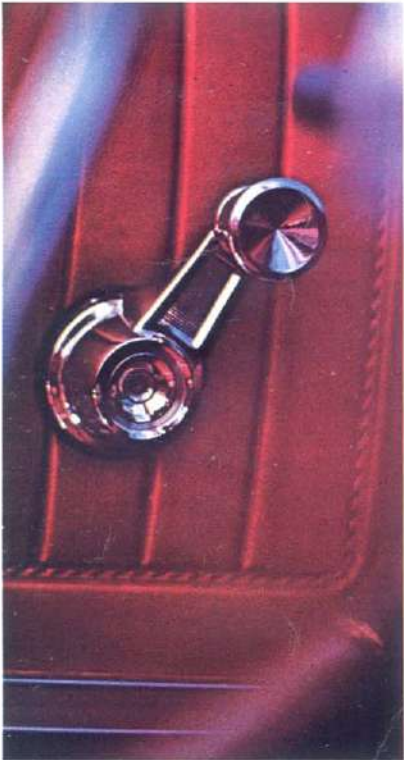
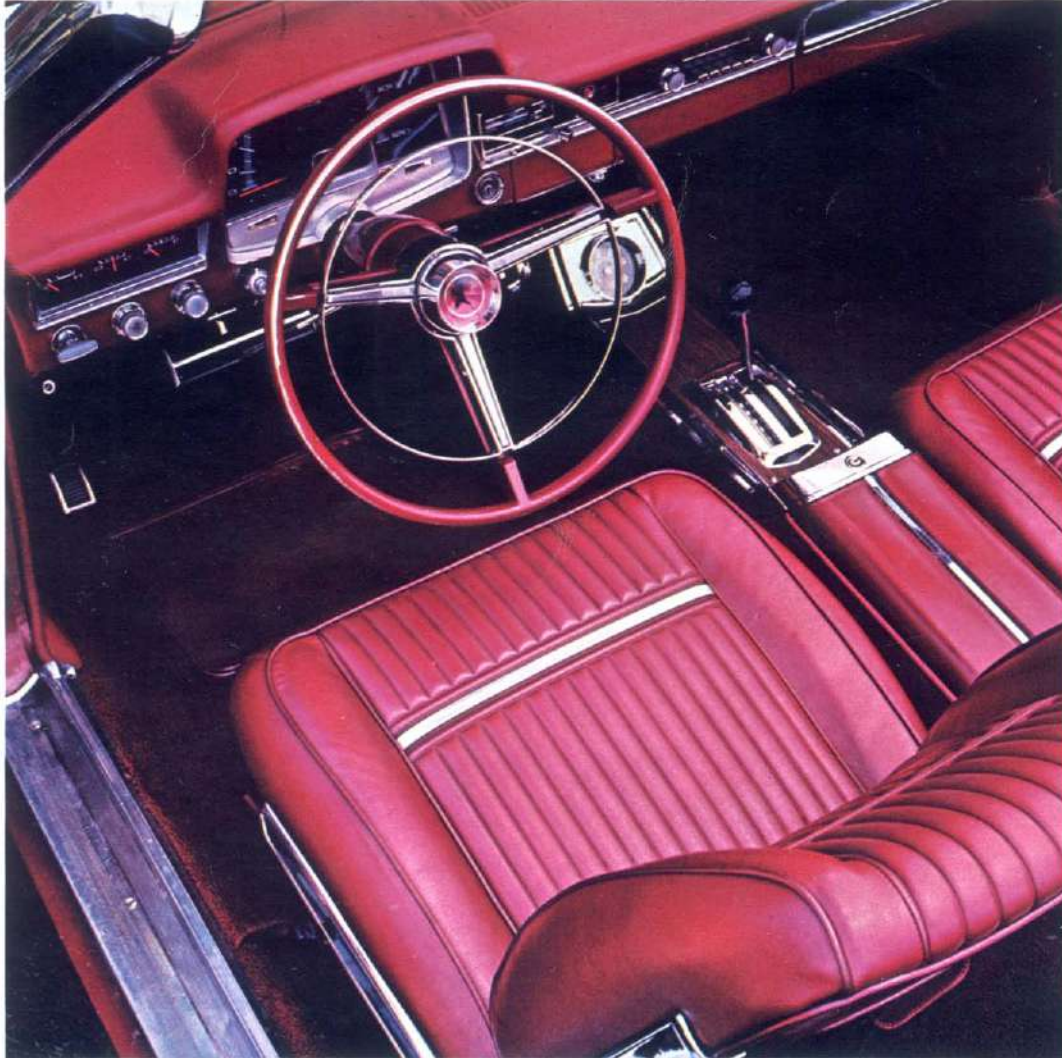

4-on-the-floor stick shift with Hurst linkage. Other features are standard from new crank-operated vent windows and special steering wheel with full horn

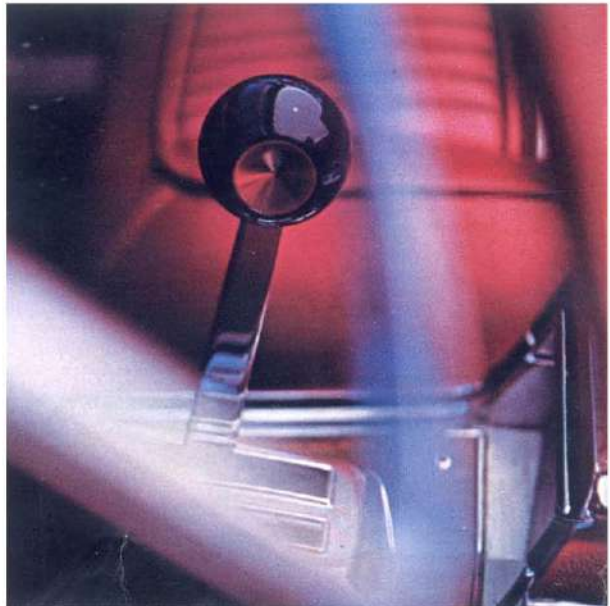

ring to the heavy chrome name plate that identifies your favorite car to the world.

Some people go through life without ever knowing the fun of owning and driving a convertible. This year's Plymouth Fury Convertible has a new type frame and linkage mechanism, operates so smoothly spirits soar . . . and when

the top is up, it provides a thin, flat roofline on the outside, a clean, neat look inside. New pocket panels conceal power units and linkage; and a new stretchable vinyl dustboot neatly covers the folded top.



*Sport Fury Convertible / medium red metallic, red interior*

# Fury III

A new paint finish of buffable acrylic enamel gives all Plymouth Furys a tough, chip-resistant, high-gloss surface. Combining the luxury of exterior size and spacious interiors, the Fury III offers a bonus of performance and economy with a Plymouth price tag. Roof rail trim molding is designed to prevent water from running off the roof onto seats when doors are opened.

**Standard features of Fury III:** 225-cu.-in. 6-cylinder engine (2-door hardtop and 4-door sedan only) or 318-cu.-in. V-8 engine; 3-speed manual transmission; vinyl and fabric interior trim; torsion-bar suspension; Oriflow shock

absorbers; self-adjusting brakes; color-coordinated, deep pile carpeting; electric windshield wipers; front and rear armrests with ash receivers in rear; heater/defroster.

*You also get:* Dual tail-lights and back-up lights; parking brake warning light; deep foam front seat cushions; sun visors, right and left; cigar lighter; alternator; electrically operated top on convertibles; front seat belts; electric clock; glove box and luggage compartment lights.

**Popular options and accessories:** 383- (2- or 4-bbl.) and 426-cu.-in. Commando

V-8 engines; 3-speed automatic transmission with steering-column-mounted selector; "4-on-the-floor" manual transmission with Hurst linkage; power brakes, power steering, and power windows; Transaudio AM or AM-FM radio; deluxe wheel covers. *You may also select:* an adjustable steering wheel; removable rear fender skirts; Auto-Pilot; electrically operated door-locking system on 4-door models; remote-control side-view mirror; day/nite mirror; all-vinyl interior; white sidewall tires; tinted glass; air conditioner; Sure-Grip differential.

**Basic specifications (4-door hardtop)**

Overall length—209.4 in.

Overall width—78.0 in.

Overall height—56.0 in.

Wheelbase—119.0 in.

Trunk capacity—16.8 cu. ft.

(Additional specifications on page 22.)



Fury III 4-door Hardtop/dark blue



*Fury III 2-door Hardtop/ruby with black vinyl-covered roof*



*Fury III 4-door Sedan / medium blue metallic*



*Fury III 2-door Hardtop / black*



*"Zoomy" is one word for Fury '65*

**Fury Station Wagons**—Each big, bold Station Wagon in the 1965 Fury line has the same clean profile, the same handsome look inside and out, as you will find in the other Furies. The ride, handling and overall feel is that of a passenger car. But ruggedness and versatility are added to make your Fury Wagon the ultimate in multi-purpose transportation. And a number of innovations have been included for even more functional value.

For instance, 4.6 inches have been added to the overall length, 5 inches to the wheelbase of the standard Fury. (And this shows up inside with nearly 100 cu. ft. of usable space!) A positive latching mechanism holds the second

seat back upright, prevents it from being forced down if cargo shifts suddenly. Stiffened floors are constructed with formed sheet metal inner panels for extra-load-carrying strength. Tailgate hinging permits tailgate to open back beyond the bumper for a longer cargo floor area. (And a spring-loaded, hinged floor panel fills the opening over bumper for a continuous, smooth floor . . . makes for easier loading and unloading.)

Spare tire stows vertically in a well behind the right wheelhouse, concealed by a removable shroud which is a continuation of the wheelhouse cover. In two-seated models, a deep, uncluttered compartment offers 10.3 cu. ft. of

extra storage space. Luggage compartment has a positive latching cover and optional key-locking cylinder.

**Wagon standard equipment**—(In addition to features listed on preceding pages.) For 9-passenger models, a rear-facing third seat; roll-down tailgate window on 2-seat wagons; power tailgate window for 3-seat Fury II and III wagons; thick, color-keyed carpeting in passenger areas; color-keyed vinoleum for cargo areas.

**Popular options and accessories**—(In addition to those items listed under various models on preceding pages.) roof luggage rack, spare tire lock, assist handles.

**Basic specifications (wagon)**

Overall length . . . 216.1 in.	Width between rear wheel housings . . . 44.9 in.
Overall width . . . 78.1 in.	Height of rear opening . . . 29.5 in.
Overall height . . . 57.0 in.	Width of rear opening at floor . . . 55 in.
Wheelbase . . . 121.0 in.	
Floor length, tailgate open, 2nd and 3rd seats folded . . . 128.9 in.	
Floor length, tailgate closed, 2nd and 3rd seats folded . . . 95.7 in.	
Floor length, tailgate open, 2nd seat up, 3rd seat folded . . . 91.7 in.	
Floor length, tailgate closed, 2nd seat up, 3rd seat folded . . . 58.5 in.	



**Fury III Station Wagon / gold**



**Comfortable seating for nine in this Fury III Wagon**



**Stiffened floors have built-in extra load-carrying strength**

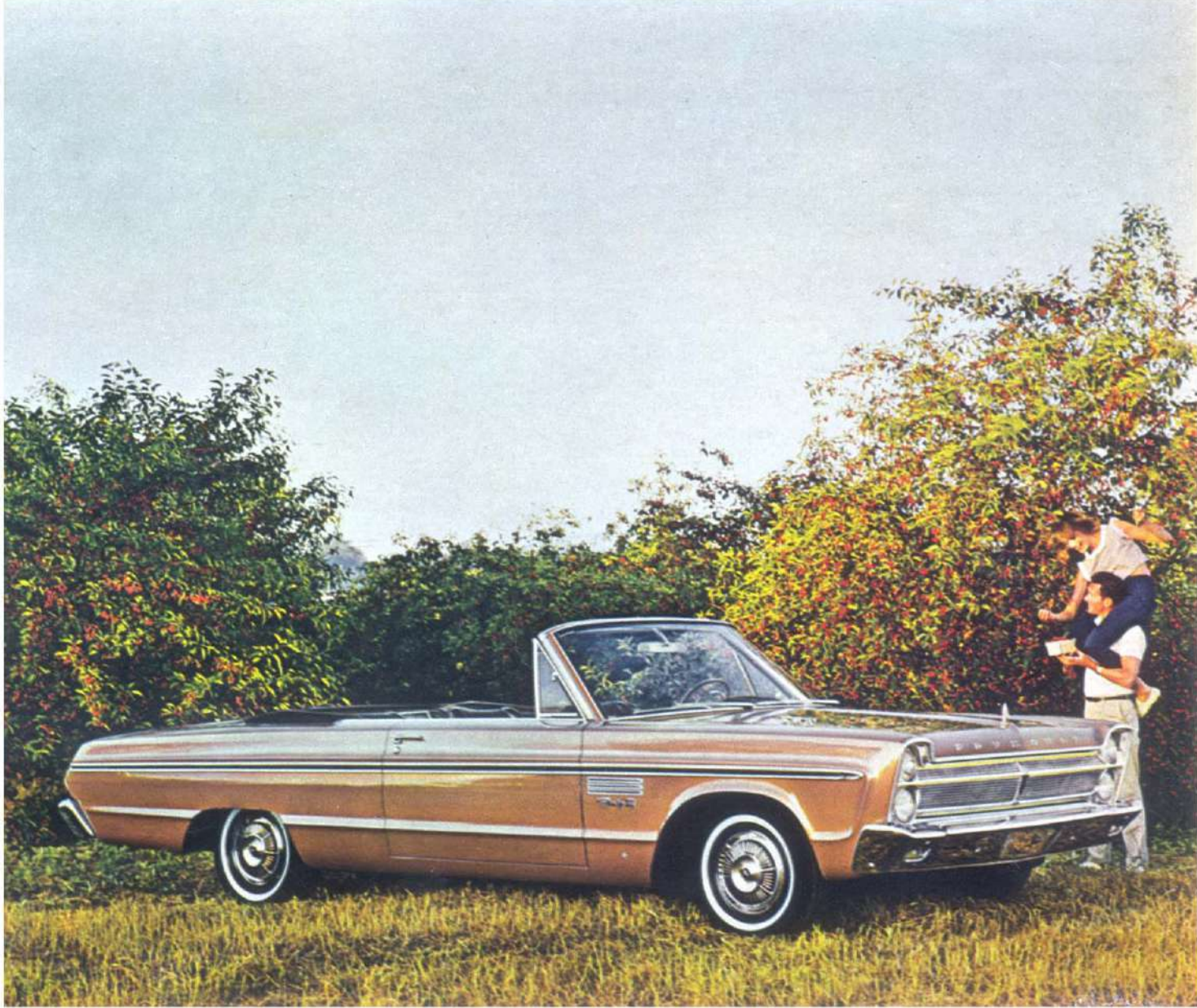

**Fury III Convertible / copper**

# Fury II

Lean and long is the look of Plymouth Fury for 1965. Deceptively thin in silhouette, roof panels are stiff and strongly supported. A continuous weatherstrip extends completely around glass openings on hardtop models from the base of the front pillar to the base of the rear pillar. The rear deck is long and level, adding both beauty to the sturdy lines of the car and adequate trunk space. **Standard features of Fury II:** 225-cu.-in. 6-cylinder engine (2- and 4-door sedans only); 318-cu.-in. V-8 engine; 3-speed manual transmission; vinyl and

fabric interiors; torsion-bar suspension; Oriflow shock absorbers; self-adjusting brakes; color-coordinated, deep-pile carpeting; single-speed electric windshield wipers; heater/defroster.

*You also get:* Front and rear armrests with ash receivers in rear; deep foam front seat cushions; sun visors, right and left; cigar lighter; alternator; front seat belts.

**Popular options and accessories:** Adjustable steering wheel; Auto-Pilot;

electrically operated door-locking system; 383- (2- or 4-bbl.) and 426-cu.-in. Commando V-8 engine; 3-speed automatic transmission; "4-on-the-floor" manual transmission with Hurst linkage; power steering; power brakes.

*And you may select:* An AM or AM-FM radio; deluxe wheel covers; white sidewall tires; tinted glass; retractable front or retractable front and rear seat belts; Sure-Grip differential; removable rear fender skirts; remote-control side-view mirror, day/nite mirror; bumper guards; air conditioner.

## **Basic specifications** (4-door sedan)

Overall length—209.4 in.

Overall width—78.0 in.

Overall height—56.0 in.

Wheelbase—119.0 in.

Trunk capacity—16.8 cu. ft.

(Additional specifications on page 22.)



*Fury II 4-door Sedan / white*



*Fury II 2-door Sedan / medium turquoise*



*Fury II 2-door Sedan interior / tan*





*Fury II Wagon has passenger car style inside and out*



*Fury II Station Wagon / ivory*

# Fury I

You can save money without sacrificing style or spacious comfort as you select a 2-door or 4-door Fury I sedan or station wagon. Each of these models has the same sturdy construction, the fine appearance and most of the basic features of the rest of the 1965 Fury line. The longer you drive one, you'll discover even this—the lowest-priced Fury—has the same lasting quality all Plymouths are famous for. If Fury's your car, but budget's your problem, take your pick from this selection.

**Fury I standard features:** 225-cu.-in. 6-cylinder engine; 318-cu.-in. V-8 engine; 3-speed manual transmission; vinyl and fabric interiors; torsion-bar suspension; Oriflow shock absorbers; self-adjusting brakes; color-keyed, deep-pile carpeting; single-speed electric windshield wipers; front and rear armrests, with ash receivers in rear; heater/defroster.

**You also get:** Sun visors, left and right; cigar lighter; front seat belts; alternator and 12-volt battery.

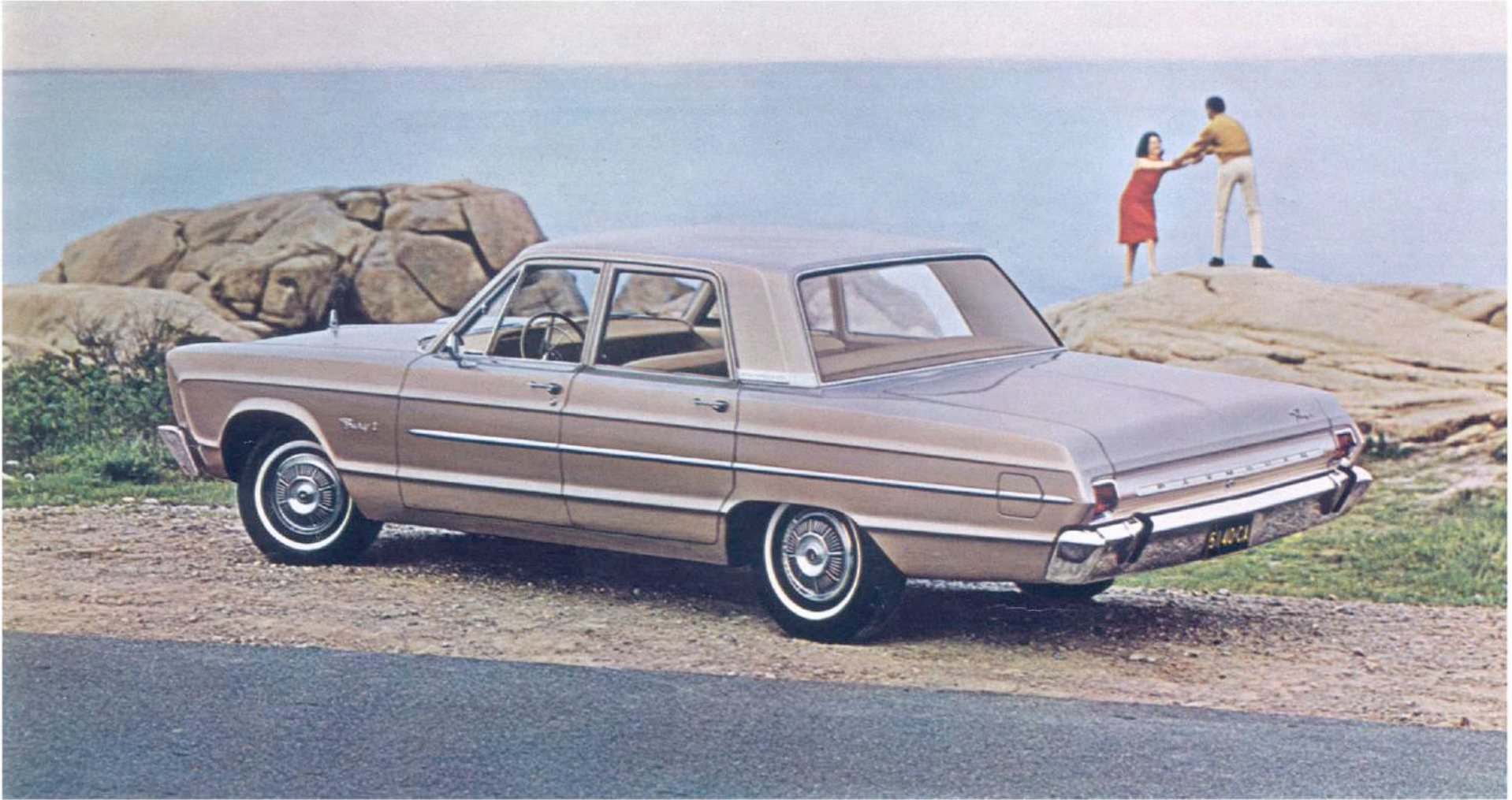

*Fury I 4-door Sedan / medium tan metallic*



*Fury I 4-door Sedan interior / tan*



**Popular options and accessories:** Adjustable steering wheel; Auto-Pilot; electrically operated door-locking system; 383- (2- or 4-bbl.) or 426-cu.-in. Commando V-8 engine; 3-speed automatic transmission or "4-on-the-floor" manual transmission with Hurst linkage; power steering, brakes; deluxe wheel covers; white sidewall tires. *You may also select:* Day/nite mirror; AM or AM-FM radio; air conditioner; padded instrument panel; Sure-Grip differential; remote-control side-view mirror; electric clock; bumper guards; back-up lights.

**Basic specifications:** (4-door sedan)

Overall length—209.4 in.

Overall width—78.0 in.

Overall height—56.0 in.

Wheelbase—119.0 in.

Trunk capacity—16.8 cu. ft.

(Additional specifications on page 22.)



**Fury I 2-door Sedan / light blue**



**Fury I Station Wagon / black**

# Options, Accessories and Engines

Plymouth Fury has more to offer in "touches of luxury" as standard equipment than any other model in the Plymouth line. Fury also offers a wide choice of extra-cost options and accessories. These are the items you pick to make the car you buy as nearly "your car" as possible.

*Additional options you'll enjoy include AM/FM radios, windshield washers and variable-speed electrically operated windshield wipers. You may add a*

*spotlight,\* trunk compartment lights† . . . even a light under the hood.\* The Auto-Pilot is a new option with Plymouth this year. Merely push a button and relax. For open-country driving, you can then remove your foot from the accelerator as the Auto-Pilot takes over and holds desired speed.*

*(For detailed information on which options are available with each model, see individual pages covering each series.)*

\*Dealer-installed options.  
†Standard on Fury III and Sport Fury.



*Power windows are a convenience you'll appreciate, especially in bad weather and when you're driving alone.*



*Aim outside mirror accurately and simply, without opening window, by adjusting control lever on inside of door panel.*

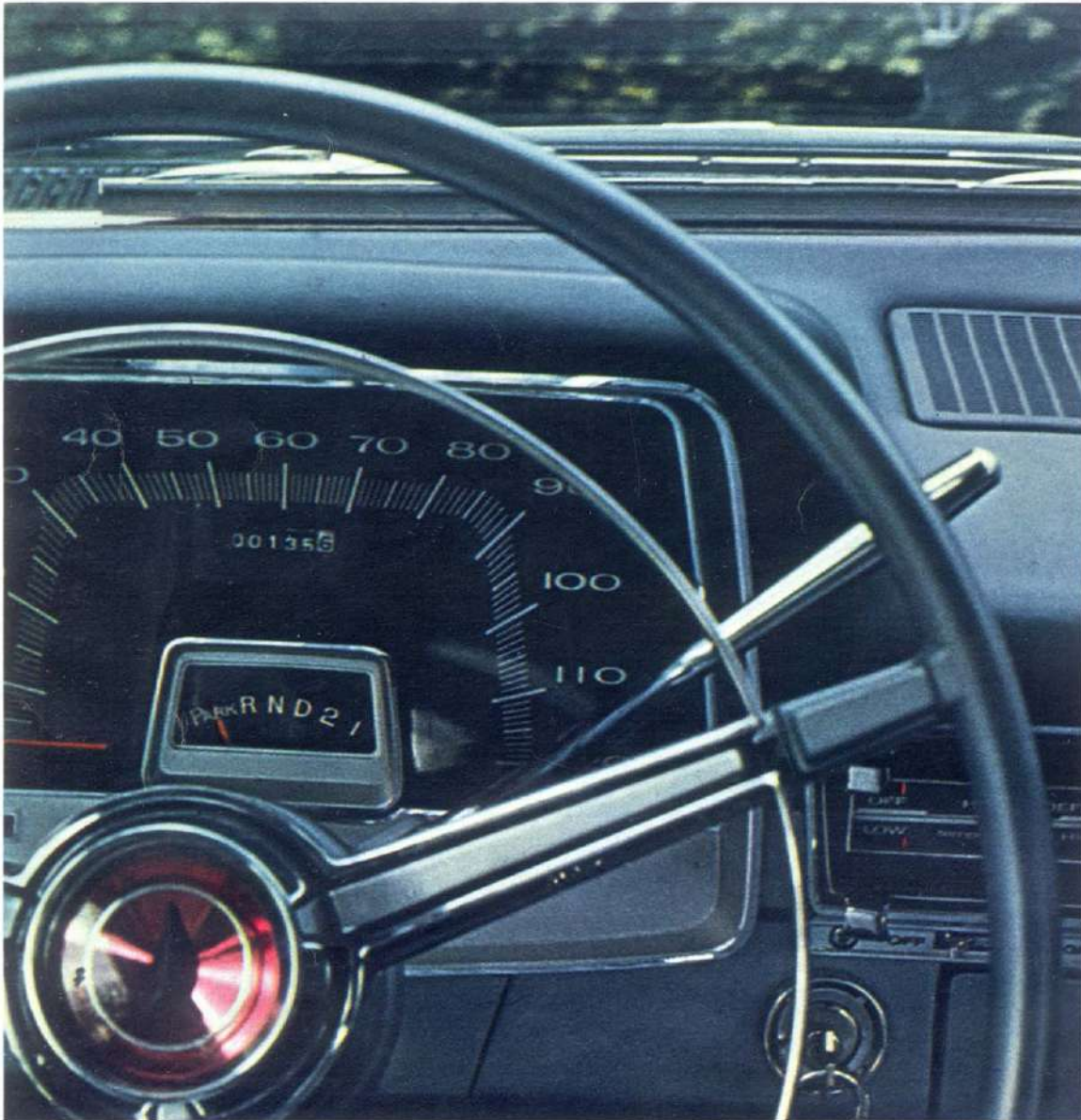

*Automatic TorqueFlite transmission lets gears shift easily, conveniently, with a steering-column-mounted selector lever. (Indicator is mounted in the lower portion of the speedometer cluster.)*



*Flick a lever for 6-way bench-type seat adjustment, with an electrically operated power assist. Bucket seats go four ways, electrically if you wish.*



*Console-mounted automatic transmission with Hurst linkage is a favorite with the sporty set.*



*Five Engines for the Fabulous Fury '65*



Economy 6



318



Commando 383 (2-bbl.)



Commando 383 (4-bbl.)



Commando 426

**ZOOMY!** Performance as you like it, when you want it. Experience gained in our labs, on our proving grounds, on the test track, racetracks and drag strips all over America has enabled Plymouth engineers to design the exact type of get-up-and-go power you desire to match the superb styling of 1965 Plymouth Furys. (See the table, right, for performance specifications.)

	Cu. In. Displ.	HP	Torque Lbs.-Ft.	Comp. Ratio	Bore/Stroke	Carb. Type
Economy 6	225	145@ 4000 rpm	215@ 2400 rpm	8.4:1	3.40x 4.125	1 bbl.
318	318	230@ 4400 rpm	340@ 2400 rpm	9.0:1	3.91x 3.31	2 bbl.
Commando 383	383	270@ 4400 rpm	390@ 2800 rpm	9.2:1	4.25x 3.38	2 bbl.
Commando 383	383	330@ 4600 rpm	425@ 2400 rpm	10.0:1	4.25x 3.38	4 bbl.
Commando 426	426	365@ 4800 rpm	470@ 3200 rpm	10.3:1	4.25x 3.75	4 bbl.

# Additional Specifications

## Brakes

Hydraulic, 11-in. diameter, 2.75-in. wide (front) and 2.0-in. wide (rear), servo-contact, self-energizing brakes, with bonded linings. Lining area is 202.1 sq. in. for both passenger cars and station wagons. Brake shoes are internal expanding type. A self-adjusting feature (activated during reverse stops) is incorporated in the design. Separate foot-operated parking brake, cable-connected, acts on each rear wheel.

## Suspension

Front..... torsion bars and ball joints  
 Rear..... 2.5-in.-wide asymmetrical leaf springs\*  
 Shock absorbers..... Oriflow type

\*5 leaves in passenger cars, 6½ in station wagons.

## Electrical system

Heavy-duty, 12-volt, 54-plate, 48-ampere-hour battery. Chrysler Corporation alternator with high charging rate even at low engine speeds.

## Rear axle ratios

(Hotchkiss drive type, hypoid rear axle)

TorqueFlite V-8..... 2.93:1  
 TorqueFlite 6..... 3.23:1  
 Manual V-8..... 3.23:1 (with 4-speed)

Manual 6..... 3.55:1 (with 3-speed)  
 Manual V-8..... 3.23:1 (with 3-speed)

## Tires and Wheels\*

	wheels	tires
6-cylinder sedans, 2-dr. hardtops.....	5K x 14	7.35 x 14
8-cylinder sedans, hardtops, convertibles.....	5.5K x 14	7.75 x 14
6-cylinder station wagons.....	5.5K x 14	8.25 x 14
8-cylinder station wagons.....	6K x 14	8.55 x 14

\*Safety-Rim Wheels with low-pressure tubeless tires standard on all models.

## Capacities

Fuel tank..... 25 gallons  
 Fuel tank, station wagons..... 22 gallons  
 Cooling system, 6-cylinder engines..... 12 quarts  
 (with heater, 13 quarts)  
 Cooling system, 8-cylinder engines..... 20 quarts  
 (with heater, 21 quarts)  
 Lubricating oil..... 4 quarts

The policy of Chrysler Corporation is one of continual improvement in design and manufacture wherever possible to assure a still finer car. Hence, specifications, equipment and prices are subject to change without notice. Product information published herein, while correct at time of publication, is subject to change. Automobiles pictured, in some cases, show optional equipment items as listed above.

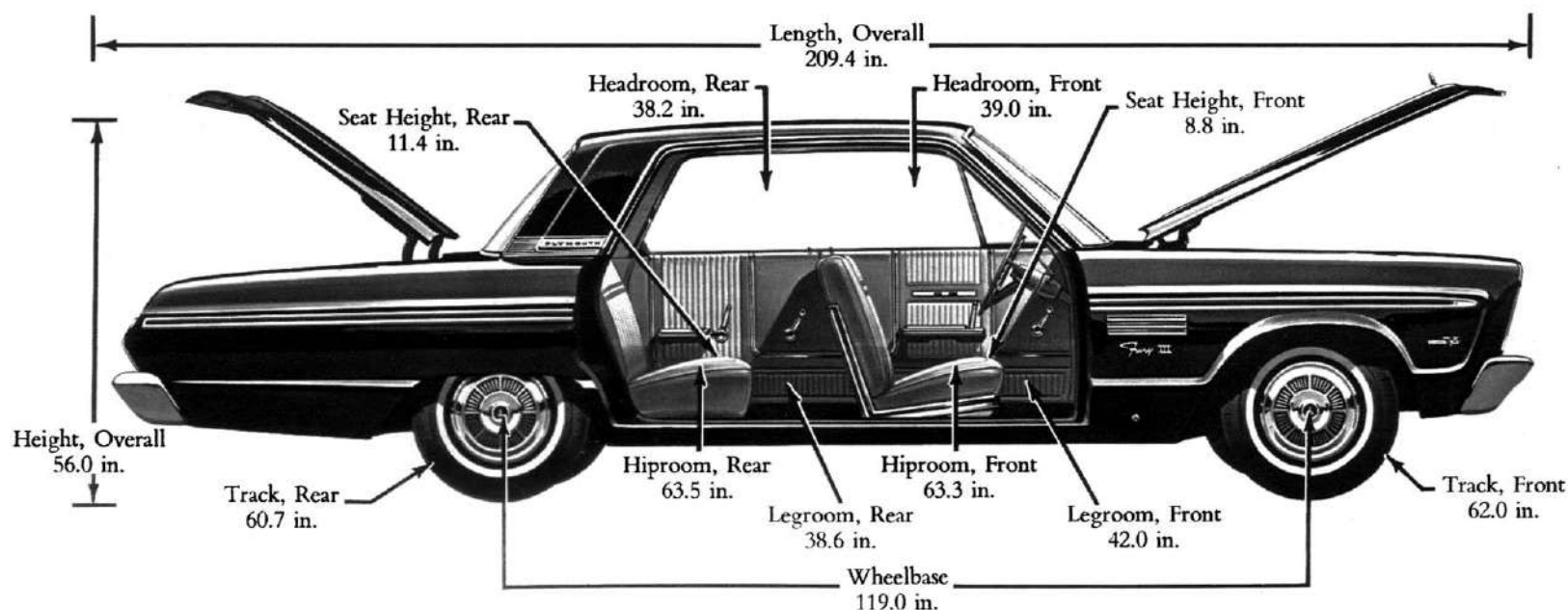
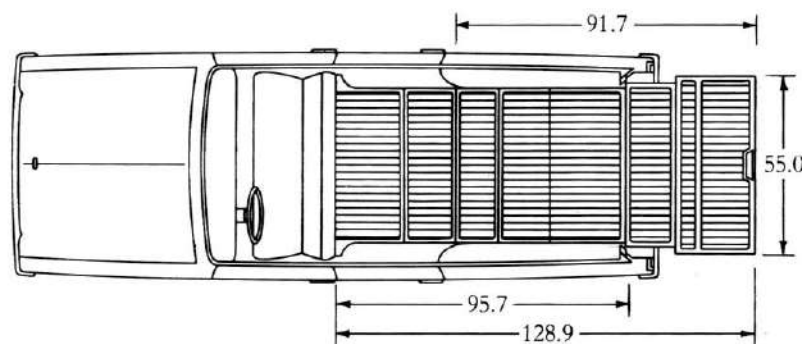
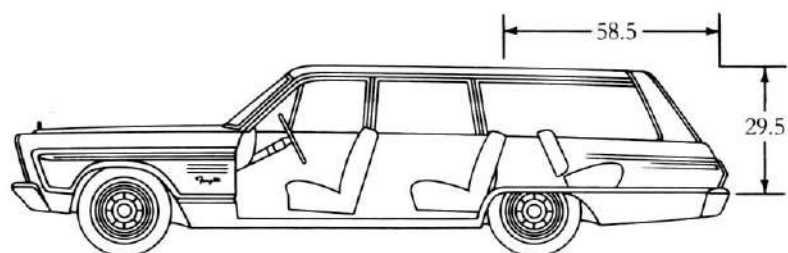

# Colors and Upholsteries

Big, bold, bright. Lean and long and crisply modern. That's the look of Plymouth Fury for 1965. Inside and out, specifically, there are 15 buffable acrylic, high-gloss exterior colors . . . a kaleidoscope of interior fabrics and patterns. *The Sport Fury*, for instance, is clad inside with rich-grained vinyls. *Fury I* body cloth is an attractive jacquard weave . . . a shingle pattern interspersed with silver metallic thread. (All-vinyl seats are standard in station wagons.) Contrasting color tones play an important role in *Fury II* interiors.

A double row of square biscuit pleats runs across the shoulder bolster. Body cloth has a ribbed, tweedy texture. Tight, vertical pleats form the dominant design of the *Fury III* interiors. Body cloth is a deep-dye, sparkle nylon . . . glossy . . . smooth to the touch. Combined with vinyl, it is standard trim on sedan and hardtops. (All-vinyl trim is optional for these models, standard on convertibles and station wagons.) Your Plymouth Fury Dealer has a complete set of the actual colors and materials for you to see, touch and choose from.



*Vinyl Bolsters*



*Cloth Inserts*



*Cloth Inserts*

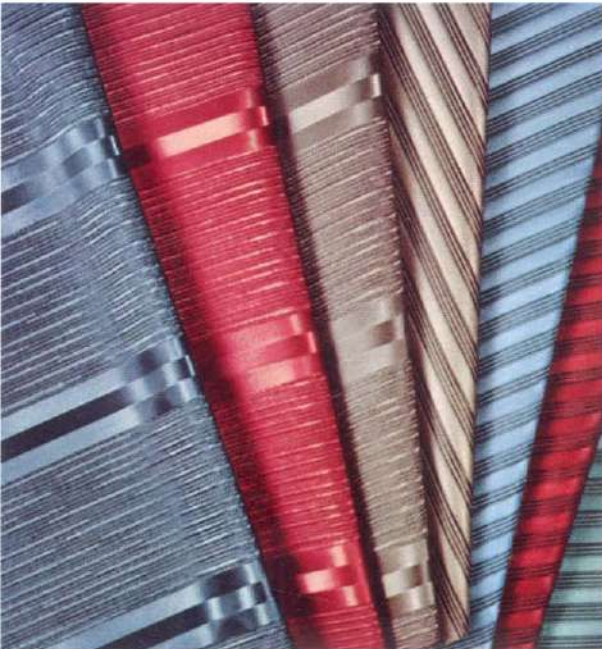

*Vinyl Inserts*



*Sport Fury All-Vinyl Interior*

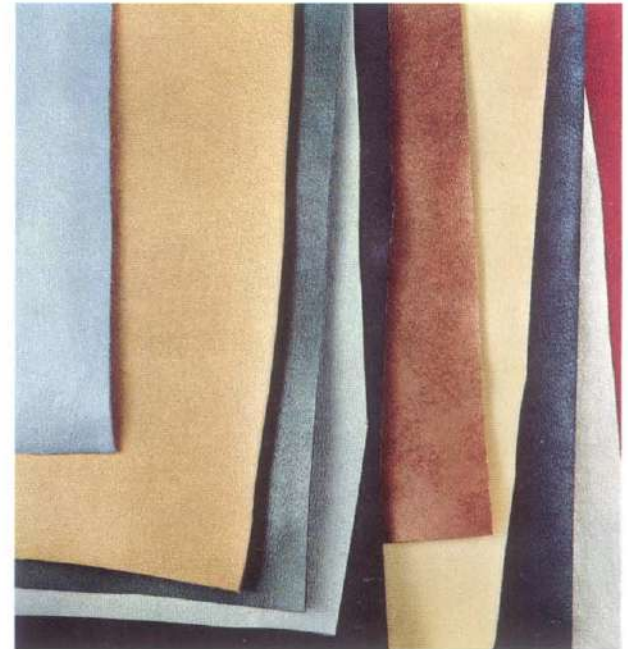

*Vinyl Inserts*

## Exterior Colors

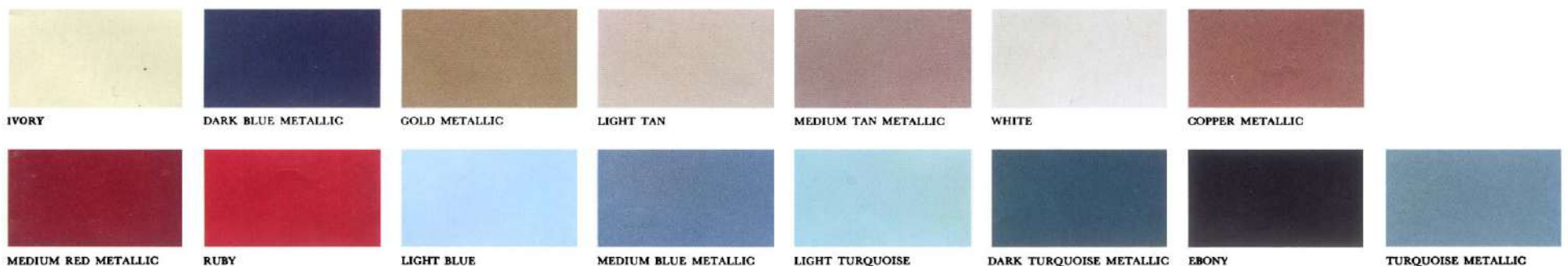

**TRAILER TOWING PACKAGE**—With torsion-bar suspension, Unibody construction and high-performance engines, Plymouth Fury has the power, directional stability, ride and handling qualities to make trailer towing safe and enjoyable when a Plymouth trailer towing package is used. TorqueFlite automatic transmission provides maximum downhill braking from the engine and top pulling power on grades. It will withstand heavier loads than manual-shift units and will permit the engine to operate at its most efficient speeds. A high ratio in low gear permits the engine to develop more power at low car speeds, where it is most useful for trailer towing. This transmission may be kept in low or second gear, for mountain driving or slow-moving traffic.

Plymouth Fury wheel bearings and rear axles have sufficient capacity to handle the additional loads imposed by a trailer. Safety-Rim wheels, standard equipment, provide extra security in case of blowouts.

Additional towing equipment is available from your Plymouth Dealer. Ask him about this special package. (Incidentally, if you plan to tow more than 2500 lbs. with your new Plymouth Fury, the Trailer Towing Package is required, to maintain your engine and drive train warranty\*.)

**TRAILER TOWING PACKAGE** □ High capacity cooling system: special radiator, high (16 psi) pressure cap, large (18-in.) fan, fan shroud, yoke-to-hood air seal □ Heavy-duty brakes (11-in., front and rear) □ Heavy-duty suspension; front and rear, with sway bar □

Wide Wheel Rims □ Heavy-duty turn signal flasher □ Heavy-duty stop lamp switch. □ Oversize tires: 7.75 x 14 (all 6-cyl. models, except wagons); 8.25 x 14 (all V-8 models, except wagons); 8.55 x 14 (station wagons). *Note: This size tire is standard on V-8 wagons.* □ Performance axle ratios—3.23 with V-8 engines, 3.55 with 6-cyl. engines. *Note: Automatic transmission and power brakes on station wagon are required with this equipment package; manual transmission not available.*



**ADDITIONAL OPTIONAL EQUIPMENT RECOMMENDED:** Power steering □ Power brakes □ High (46-amp.) output alternator □ Heavy-duty battery (70 amp-hr.) with heat shield □ Sure-Grip differential (not available on 6-cylinder engine).

**BEFORE YOU GO . . .** Trailer towing with your new Plymouth Fury will present no great problems if you follow a few simple rules:

*Increase air pressure* in all tires 4 pounds over normal pressure.

*Do not exceed trailer tongue load* (weight that's carried on the car, rather than the trailer's wheels) of 250 lbs., unless frame-type load-equalizing hitch is used.

**AS YOU GO . . .** *When launching your boat,* always be sure to have your service dealer check the rear axle lubricant of your car if the rear axle should happen to submerge.

*With TorqueFlite,* switch to second when going up or down steep grades. This provides better pulling power and more effective downhill braking and engine cooling. It also reduces torque-converter action, which improves gas economy.

*With air conditioning,* to avoid engine overheating, use a lower gear when climbing hills. Shift to neutral while stopped in heavy traffic and idle the engine at higher-than-normal speeds. Reduce speed when cruising on the highway. (If engine continues to overheat, shut off air conditioner temporarily, until engine temperature returns to normal.)

**ENGINE AND DRIVE TRAIN WARRANTY COVERAGE . . .** Trailer towing puts an extra load on the engine, transmission and rear axle of any car. These parts are warranted\* for five years or 50,000 miles on your 1965 Plymouth Fury, when the car is equipped with the trailer towing package that meets the weight requirements specified above. It is recommended that the driving precautions contained herein be followed to reduce the possibility of abnormal use.

**\*HERE'S HOW PLYMOUTH'S STRONG WARRANTY PROTECTS YOU:** Chrysler Corporation warrants for 5 years or 50,000 miles, whichever comes first, against defects in materials and workmanship and will replace or repair at a Chrysler Motors Corporation Authorized Dealer's place of business, the engine block, head and internal parts, intake manifold, water pump, transmission case and internal parts (excluding manual clutch), torque converter, drive shaft, universal joints, rear axle and differential, and rear wheel bearings of its 1965 automobiles, provided the owner has the engine oil changed every 3 months or 4,000 miles, whichever comes first, the oil filter replaced every second oil change and the carburetor air filter cleaned every 6 months and replaced every 2 years, and every 6 months furnishes to such a dealer evidence of performance of the required service, and requests the dealer to certify (1) receipt of such evidence and (2) the car's then current mileage.