

It takes seven people like no other can

Mazda CX-9 spoils you with luxury and space

And the thrill of a truly sporting spirit

It's an SUV experience beyond what you've imagined



zoom-zoom
zoom-zoom
zoom-zoom

SEVEN SEATS HAVE NEVER MOVED LIKE THIS

Its looks are a long way from those same-old SUVs, and so is the way the Mazda CX-9 drives.

A smooth 3.7 litre V6 engine lets you effortlessly move people and gear, or really power on when the feeling takes you. You'll barely notice the Activematic transmission shifting through its six-speeds. Fully independent suspension keeps you blissfully unaware of bumps in the road and corners with the sort of roll-free composure full size SUVs normally can't deliver. Active Torque Split All-Wheel Drive extracts every last bit of

enjoyment the road has to offer, constantly assessing conditions and distributing torque with grippy precision. Or opt for the front-wheel drive model, which goes all out to spoil you with space and luxury.

Either way, the superb drive is enhanced by dynamic style. Mazda CX-9 captures the imagination of our 'KODO - Soul of Motion' design direction. 'KODO' captures the powerful beauty of the moment energy becomes motion - seen in an animal pouncing, or a human leaping into action.



Smooth and strong. V6 engine produces 204kW and 367Nm of torque. It works in powerful harmony with responsive Activematic transmission.

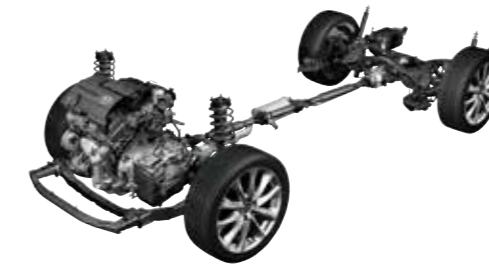

Enjoy the ride. Mazda CX-9 treats you to the smooth ride of supple independent suspension, which combines with Active Torque Split All-Wheel Drive in selected models.





***SPOIL THE FAMILY,
ESPECIALLY YOURSELF***

Talk about being well looked after. There's three-zone climate control to keep everyone in their comfort zone, and standard Bluetooth® for hands-free calls and wireless streaming of all your tunes. You've got no end of handy places for coffee, coins and other stuff. The soft leather-wrapped steering wheel adjusts this way and that to position you perfectly and carries cruise and audio controls so you barely have to budge.

A 5.8 inch colour LCD links to the reverse camera, and also tells you where CD, radio and audio settings are at – all with a mere touch. Luxury and Grand Touring models include satellite navigation by TomTom to get you where you want to go.

Sound good? So does the in-dash CD player. Luxury and Grand Touring carry you away on an irresistible 277 watt, 10 speaker wave of Bose® audio. Every model lets you plug in an iPod® or memory stick via a USB input.

MP3 WMA Bluetooth® BOSE® Navigation by **TOMTOM®**

NO WONDER EVERYONE WANTS TO COME ALONG

It doesn't just accommodate seven; it spoils them with all the personal space they can imagine.

Jump in the driver's seat in Luxury or Grand Touring models and enjoy power adjustable seats with heating function and 3-position memory. All seats are full-size and offer lots of leg-room, so passengers won't feel cramped

by the chair in front, or anybody else. One pull of a handle opens the 3rd-row up for access. Both 2nd and 3rd-row go out of their way to make things easy, splitting and folding to take cargo room from generous to enormous.

Leave the seats in place and you'll still make light work of most loads. There are all kinds

of places to store all kinds of stuff, from console compartments to cupholders for passengers in the back.

And the comfort just keeps coming. Not content with offering room for the whole family, Mazda CX-9 adds all the extra touches. The Classic grade seats you on black cloth trim that feels a cut above. Beyond that

it's flat out opulence, with Luxury and Grand Touring boasting rich leather³ trim in either elegant sand or black, power adjustable heated front seats and a sunroof.

In fact every model makes your life easy; power windows, rain-sensing wipers and automatic on/off headlamps are included as standard equipment.



Luxury of choice. Luxury and Grand Touring models indulge you with leather trim in a tasteful choice of colours.





Family room. Seven full-sized seats, generous luggage space and impressive versatility just perfect for family life.



Jump in. Just pulling a latch opens up access to comfortable 3rd-row seating.



Clear to see. High legibility white-on-black instrument cluster.



Open to anything. Both 2nd and 3rd-row seats can be folded flat to create enormous load space. 50/50 split 3rd-row seats fold easily for added flexibility.

You're sorted. Centre armrest console conveniently opens in two parts, revealing a large storage compartment. Illuminated glove box extends storage options, while rear cupholders make passengers welcome.



All mapped out. TomTom based satellite navigation is standard on Luxury and Grand Touring. Large 5.8 inch touch screen makes directions clear.

Keep in touch. All models feature Bluetooth® connectivity, allowing you to talk with hands-free ease and safety.

SOMEWHERE THE FAMILY CAN FEEL SAFE

Mazda CX-9 takes your safety very seriously.

The Mazda Advanced Impact Distribution and Absorption System (MAIDAS) augments the extremely rigid passenger cell by absorbing and redirecting impact energy away from it.

Side-impact door beams are integrated and there are front and side-impact airbags, plus full-length curtain airbags covering all three rows as standard.

Front seats feature belt pretensioners and load-limiters. And it's good to know Dynamic Stability Control (DSC)

is there to help prevent skids or loss of control on slippery roads.

Also on your side are ABS with Electronic Brake-force Distribution (EBD), Emergency Brake Assist (EBA) and Roll Stability Control (RSC), which detects potential rollovers and automatically stabilises the vehicle.

Intruders are fended off by remote central locking and an engine immobiliser. Add a reverse camera for safer reversing and you've got great protection from front to back.



An extra pair of eyes. Shift into reverse and the reverse camera automatically shows you onscreen, what's behind you.

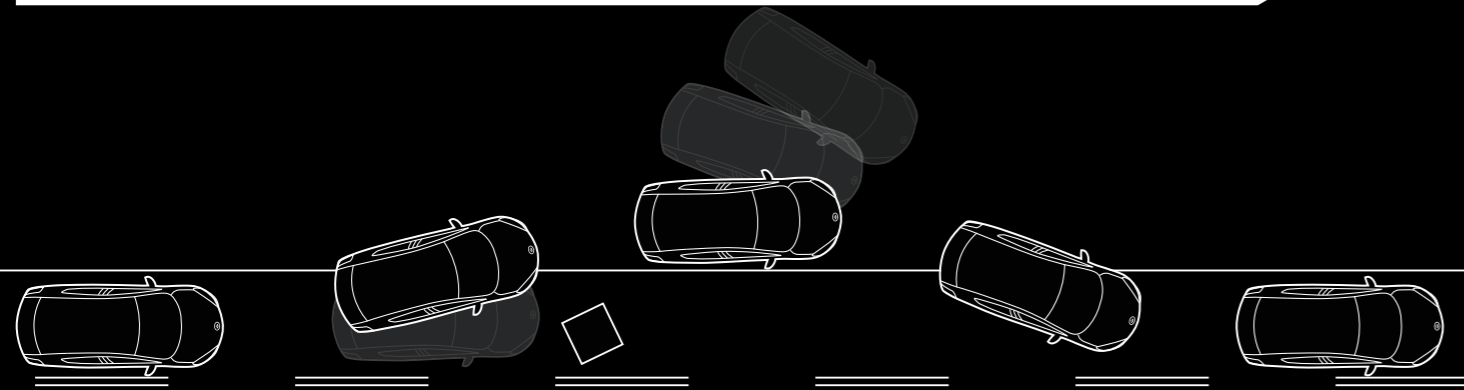

What if you're faced with an unanticipated hazard on the road and have to react suddenly?

DSC acts instantly, braking the inner rear wheel to counter understeer (or outer front wheel to counter oversteer). At the same time, the Traction Control System (TCS) reduces torque to the driven wheels to minimise slip. As a result, control is maintained and the vehicle can be safely steered around the obstacle.

Built-in safety. Front and side-impact airbags, including full-length curtain airbags, are integrated to ensure all passengers enjoy the highest level of protection.

Stopping with certainty. Stopping distance with EBA, ABS and EBD.

Stopping distance with no assistance.



Safety sign. Should you need to brake suddenly from speed, the Emergency Stop Signal (ESS) system automatically flashes the hazard lights, giving advance warning to the driver behind.



Safety through and through. 'Triple H' construction combines strong safety cell with front and rear crumple zones. It's all part of our advanced MAIDAS.

ENJOY A TECHNOLOGICAL ADVANTAGE

Mazda CX-9 boasts an array of advanced systems that enhance your safety, convenience and of course, your enjoyment of its refined driving dynamics.

Right through the model line-up you're rewarded by thoughtful and imaginative features. This ranges from standard equipment like Bluetooth® and a reverse camera, through to Grand Touring's impressive list of the very latest technological aids.

GRAND TOURING IN ZEAL RED MICA

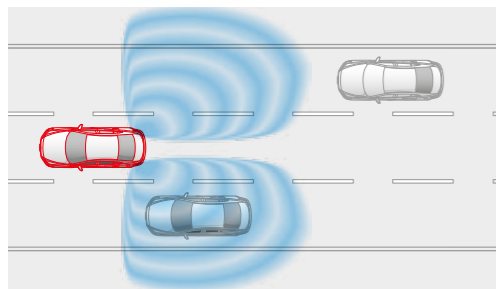

Blind Spot Monitoring (BSM).

By scanning external mirrors' blind spots, this system warns of any obscured vehicles to help you avoid making hazardous lane changes. LED icon on the relevant mirror is accompanied by warning beeper. Grand Touring only.

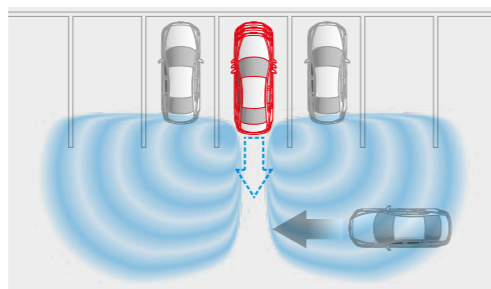

Rear Cross Traffic Alert (RCTA).

RCTA assists you when you're reversing from a parking space, warning if a car is approaching from either side of your vehicle. LED icon on outside mirrors is accompanied by warning beeper. Grand Touring only.

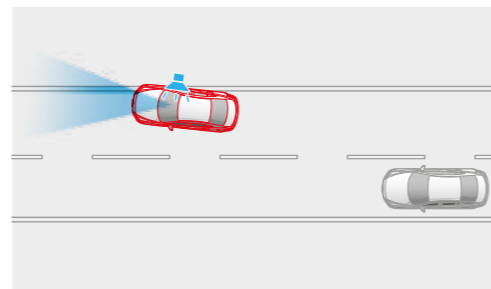

Lane Departure Warning (LDW).

Using a windscreen-mounted camera to monitor road lane markings, this system gives you an audible warning if you're about to stray from your lane. Grand Touring only.

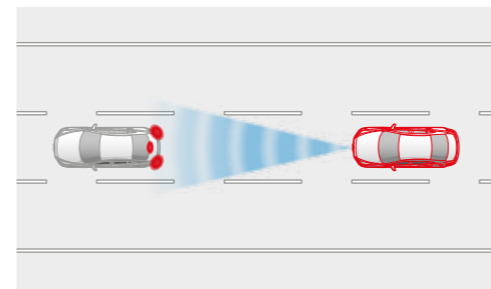

Forward Obstruction Warning (FOW).

If Mazda CX-9 gets close enough to the vehicle in front for a collision to be a possibility, its driver is prompted to take evasive action via an audible warning and a visual alert. Grand Touring only.

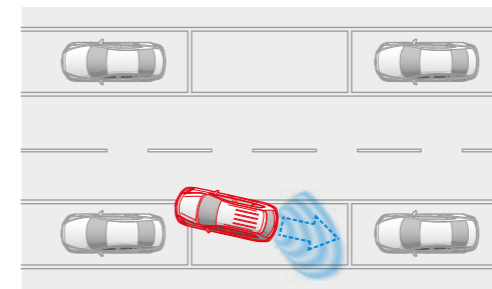

Rear parking sensors.

Combining with the standard reverse camera, sensors at the rear of the vehicle sound warnings to make parking easier, and help avoid parking bumps or scratches. Grand Touring only.

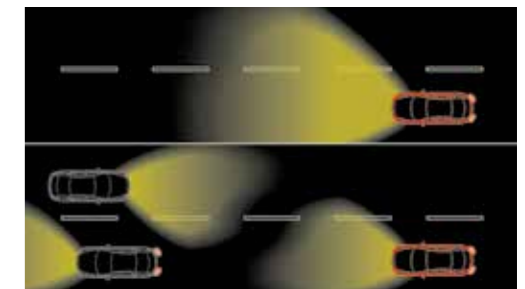

High Beam Control (HBC).

Enjoy the enhanced safety of high beam illumination, without having to manually switch to low-beam. A camera detects oncoming cars' headlights, or the taillights of cars in front, and automatically switches to low-beam then back when it's safe. Also selects low beam in lit areas or at low speed. Grand Touring only.

CX-9 CLASSIC

Mazda CX-9 Classic spoils up to seven people with stylish luxury. It also spoils drivers with responsive performance.

- 3.7 litre V6 24 valve DOHC S-VT
- Max. power: 204 kW @ 6,250 rpm
- Max. torque: 367 Nm @ 4,250 rpm
- 6-speed Activematic (auto) transmission
- 18 inch alloy wheels with 245/60 tyres
- Fog-lamps (front)
- Headlamps (Halogen)
- Power mirrors (body coloured)
- Power windows
- Rear spoiler
- Air-conditioning
(three-zone climate control with independent rear control)
- Bluetooth® (hands-free compatible)²
- Cruise control
- Headlamps auto on/off function
- Leather-wrapped gear shift knob and steering wheel
- Seat trim: cloth
- Seats (2nd row) with: 60/40 split-fold backrest
- Seats (3rd row) with: 50/50 split-fold backrest (flat fold)
- Trip computer
- Wipers (front) 2-speed with rain-sensing function
- AM/FM tuner with CD player, single disc (MP3/WMA compatible) and 6 speakers
- Auxiliary input (3.5 mm MP3 player compatible)
- Bluetooth® audio (MP3 player compatible)²
- USB input (iPod® compatible)
- Airbags SRS: front (driver and passenger), side (front) and curtain (front and rear)
- Anti-lock Braking System (ABS)
- Dynamic Stability Control (DSC)
- Reverse camera
- Roll Stability Control (RSC)
- Seat-belts 3-point lap-sash (all seats)
- Towing capacity (braked) 2,000 kg⁶



FWD



You're connected. Standard Bluetooth® allows hands-free connection of phone calls and wireless streaming of all your tunes.



On screen. Easy-to-read 5.8 inch LCD shows you audio functions and rear-view images.



Comfort from front to back. Control panel lets rear seat passengers choose their preferred temperature.



Enjoy the elements. Fresh air and sunshine; power-sliding glass sunroof can also be tilted.

Right on track. Satellite navigation by TomTom has features such as spoken street names, advanced lane guidance, even a latest map guarantee.

Stirring sounds. Be moved by the impressive power and performance of 277 watt, 10 speaker Bose® audio.

CX-9 LUXURY

There's even more to indulge you in CX-9 Luxury. With its extra style and features, it treats seven people to a special experience.

Luxury features additional to the Classic include:

- Active Torque Split (ATS) All-Wheel Drive system (AWD model only)
- 20 inch alloy wheels with 245/50 tyres
- Door handles (chrome)
- Power mirrors (heated with 3-position memory and reverse tilt-down function)
- Power-sliding and tilt glass sunroof
- Satellite navigation (TomTom)
- Seat trim: leather³
- Seats (front) with: power adjustment (driver and passenger), heating function (driver and passenger) and 3-position memory function (driver)
- Premium Bose® 277 watt amplifier and 10 speakers (including subwoofer)

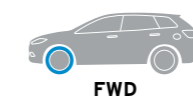

CX-9 GRAND TOURING

CX-9 Grand Touring spoils its occupants in the grandest possible way. Its added technology indulges you with the highest levels of convenience and safety.

Grand Touring features additional to the Luxury include:

- Daytime running lamps (LED)
- Headlamps (Bi-Xenon)
- Remote operated power tailgate (open/close)
- Advanced keyless entry and engine start
- Rear-view mirror with auto dimming function
- Blind Spot Monitoring (BSM)
- Forward Obstruction Warning (FOW)
- High Beam Control (HBC)
- Lane Departure Warning (LDW)
- Parking sensors (rear)
- Rear Cross Traffic Alert (RCTA)



AWD



Clear advantage. Bi-Xenon headlamps provide a longer, broader beam of high intensity light for superior vision. LED daytime running lights make you more visible to other drivers.



It's automatic. Power tailgate unlocks, opens and closes via a button on the remote locking unit. Also shuts via handy button on base of tailgate.



Keyless means effortless. Advanced keyless entry lets you get in and go without searching for keys. By carrying the remote locking fob you simply enter by pressing a button on either front door and start up via a keyless ignition switch.



SPECIFICATIONS

FWD Classic

FWD Luxury

AWD Luxury

AWD Grand Touring

Powertrain

Engine type	3.7 litre V6 24 valve DOHC S-VT			
Engine capacity	3,726 cc			
Bore and stroke	95.5 mm x 86.7 mm			
Compression ratio	10.3 : 1			
Maximum power	204 kW @ 6,250 rpm			
Maximum torque	367 Nm @ 4,250 rpm			
Throttle control	Electronic (drive-by-wire)			
Fuel system	Electronic port injection			
Fuel tank capacity	76 litres			
Recommended fuel	Unleaded (91RON or higher) or E10			
Fuel consumption ¹	combined	11.0 (FWD) 11.2 (AWD) litres per 100 km		
Emissions standard	Euro stage V			
Activematic (auto) transmission	6-speed			
Gear ratio	1st	4.148		
	2nd	2.370		
	3rd	1.555		
	4th	1.154		
	5th	0.859		
	6th	0.685		
	reverse	3.393		
	final drive	3.464		

Chassis

All-Wheel Drive (AWD) system	-	-	Active Torque Split (ATS)	Active Torque Split (ATS)
Brake diameter	front	320 mm		
	rear	325 mm		
Brake type	front	Ventilated disc		
	rear	Ventilated disc		
Steering type	Hydraulic power assist steering			
Suspension	front	MacPherson strut		
	rear	Multi-link		
Turning circle	kerb to kerb	11.4 m		
Tyre size	245/60 R18	245/50 R20	245/50 R20	245/50 R20
Tyre index	104H	102V	102V	102V
Wheel size	18 x 7.5 J	20 x 7.5 J	20 x 7.5 J	20 x 7.5 J
Wheel type	Alloy	Alloy	Alloy	Alloy
Tyre size (spare)	195/80 R17	195/80 R17	195/80 R17	195/80 R17
Wheel type (spare)	Steel	Steel	Steel	Steel

Weights and capacities

Seating capacity	7			
Cargo room	volume (VDA) ⁴	267 litres	267 litres	267 litres
	volume (VDA) ⁵	928 litres	928 litres	928 litres
Kerb weight		1,939 kg	1,969 kg	2,073 kg
Tow-ball download	maximum	150 kg	150 kg	150 kg
Towing capacity ⁶	braked	2,000 kg	2,000 kg	2,000 kg
	unbraked	750 kg	750 kg	750 kg

FWD Classic

FWD Luxury

AWD Luxury

AWD Grand Touring

Dimensions

Ground clearance	laden	147 mm	147 mm	147 mm	147 mm
Overall length		5,106 mm	5,106 mm	5,106 mm	5,106 mm
Overall width		1,936 mm	1,936 mm	1,936 mm	1,936 mm
Overall height		1,728 mm	1,728 mm	1,728 mm	1,728 mm
Track	front	1,654 mm	1,654 mm	1,654 mm	1,654 mm
	rear	1,644 mm	1,644 mm	1,644 mm	1,644 mm
Wheelbase		2,875 mm	2,875 mm	2,875 mm	2,875 mm

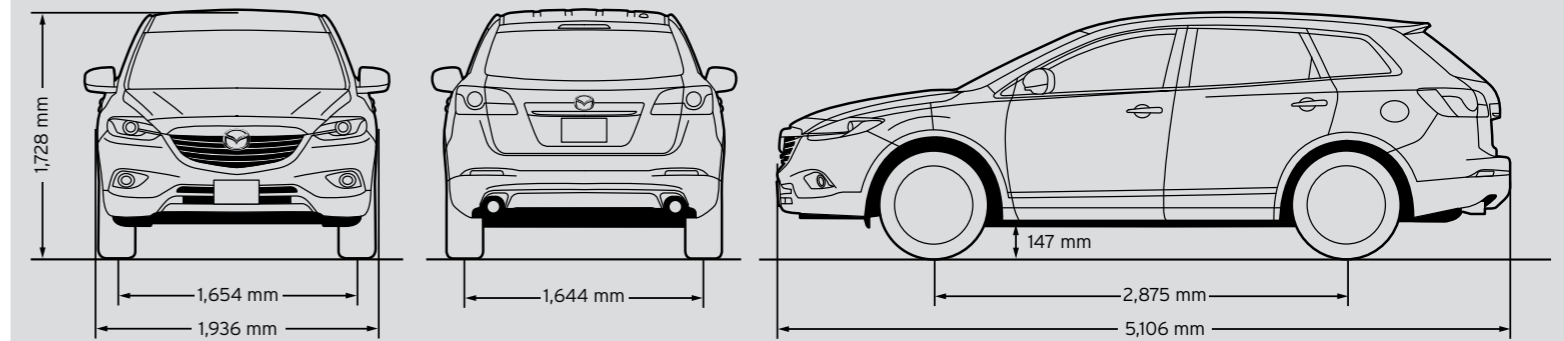

Exterior

Aerial printed into rear glass	●	●	●	●
Daytime running lamps (LED)	-	-	-	●
Door handles (chrome)	-	●	●	●
Exhaust extensions (chrome)	●	●	●	●
Fog-lamps (front)	●	●	●	●
Front and rear bumpers (body coloured)	●	●	●	●
Green-tinted windscreen, side and rear windows	●	●	●	●
Headlamps (Bi-Xenon)	-	-	-	●
Headlamps (Halogen)	●	●	●	-
Metallic/Mica paint	●	●	●	●
Mudflaps (front and rear)	●	●	●	●
Power mirrors (body coloured)	●	●	●	●
Power mirrors (heated with 3-position memory and reverse tilt-down function)	-	●	●	●
Power-sliding and tilt glass sunroof	-	●	●	●
Power windows	●	●	●	●
Rear spoiler	●	●	●	●
Remote operated power tailgate (open/close)	-	-	-	●
Roof rack mounting points	●	●	●	●

● Standard Feature - Not Available

SPECIFICATIONS

FWD Classic FWD Luxury AWD Luxury AWD Grand Touring

Interior		FWD Classic	FWD Luxury	AWD Luxury	AWD Grand Touring
Advanced keyless entry and engine start		-	-	-	●
Air-conditioning (three-zone climate control with independent rear control)		●	●	●	●
Ambient temperature display		●	●	●	●
Bluetooth® (hands-free compatible) ²		●	●	●	●
Cargo area 12 volt power outlet		●	●	●	●
Cargo area tie-down hooks		●	●	●	●
Cargo area underfloor storage box		●	●	●	●
Centre armrest console		●	●	●	●
Critical function warning lights/chimes		●	●	●	●
Cruise control		●	●	●	●
Cupholders		●	●	●	●
Digital clock		●	●	●	●
Door map pockets (front)		●	●	●	●
Driver's left footrest		●	●	●	●
Glasses storage compartment		●	●	●	●
Glove box (illuminated)		●	●	●	●
Headlamps auto on/off function		●	●	●	●
Heating ducts to second and third row passengers		●	●	●	●
Illuminated entry system with delayed fade		●	●	●	●
Instrument panel light dimmer		●	●	●	●
Interior illumination:	cargo room lamp	●	●	●	●
	map reading spot lamps	●	●	●	●
	power window switches	●	●	●	●
Interior release for fuel filler door		●	●	●	●
Leather-wrapped:	gear shift knob	●	●	●	●
	steering wheel	●	●	●	●
Passenger assist grips (front and rear)		●	●	●	●
Rear-view mirror with auto dimming function		-	-	-	●
Satellite navigation (TomTom)		-	●	●	●
Seat trim:	cloth	●	-	-	-
	leather ³	-	●	●	●
Seats (front) with:	3-position memory function (driver)	-	●	●	●
	4-way power adjustment (passenger)	-	●	●	●
	8-way power adjustment (driver)	-	●	●	●
	adjustable head restraints	●	●	●	●
	heating function	-	●	●	●
	height adjustment (driver)	●	●	●	●
	lumbar adjustment (driver)	●	●	●	●
	rake and slide adjustment	●	●	●	●
	seat back pockets	●	●	●	●
	seat-base tilt adjustment (driver)	-	●	●	●
Seats (2nd row) with:	60/40 split-fold backrest	●	●	●	●
	adjustable head restraints	●	●	●	●
	centre fold down armrest	●	●	●	●
	rake and slide adjustment	●	●	●	●
Seats (3rd row) with:	50/50 split-fold backrest (flat fold)	●	●	●	●
	adjustable head restraints	●	●	●	●
Tachometer and electronic odometer/tripmeter		●	●	●	●
Tilt and telescopic adjustable steering wheel		●	●	●	●

FWD Classic FWD Luxury AWD Luxury AWD Grand Touring

Interior (continued)	FWD Classic	FWD Luxury	AWD Luxury	AWD Grand Touring
Trip computer (current and average fuel consumption, distance to empty and average vehicle speed)	●	●	●	●
Vanity mirrors (front) with illumination	●	●	●	●
Ventilation pollen filter	●	●	●	●
Window demister (rear)	●	●	●	●
Wipers (front) 2-speed with rain-sensing function	●	●	●	●
Wiper (rear) with intermittent function	●	●	●	●

Audio	FWD Classic	FWD Luxury	AWD Luxury	AWD Grand Touring
AM/FM tuner	●	●	●	●
Auxiliary input (3.5 mm MP3 player compatible)	●	●	●	●
Bluetooth® audio (MP3 player compatible) ²	●	●	●	●
CD player, single disc (MP3/WMA compatible)	●	●	●	●
Premium Bose® 277 watt amplifier and speakers (including subwoofer)	-	●	●	●
Speakers (6)	●	-	-	-
Speakers (10)	-	●	●	●
Steering wheel-mounted audio controls	●	●	●	●
USB input (iPod® compatible)	●	●	●	●

Safety	FWD Classic	FWD Luxury	AWD Luxury	AWD Grand Touring
Airbags SRS: front (driver and passenger), side (front), curtain (front and rear)	●	●	●	●
Anti-lock Braking System (ABS)	●	●	●	●
Blind Spot Monitoring (BSM)	-	-	-	●
Child restraint anchor points (2nd row only)	●	●	●	●
Childproof rear door locks	●	●	●	●
'Dual stage' door unlocking function	●	●	●	●
Dynamic Stability Control (DSC)	●	●	●	●
Electronic Brake-force Distribution (EBD)	●	●	●	●
Emergency Brake Assist (EBA)	●	●	●	●
Emergency Stop Signal (ESS)	●	●	●	●
Engine immobiliser	●	●	●	●
Forward Obstruction Warning (FOW)	-	-	-	●
High Beam Control (HBC)	-	-	-	●
High mount stop lamp	●	●	●	●
Lane Departure Warning (LDW)	-	-	-	●
Left-hand-side convex (wide angle) exterior mirror	●	●	●	●
One touch (up and down) power window (driver and passenger)	●	●	●	●
Parking sensors (rear)	-	-	-	●
Rear Cross Traffic Alert (RCTA)	-	-	-	●
Remote central locking (2 transmitters)	●	●	●	●
Reverse camera	●	●	●	●
Roll Stability Control (RSC)	●	●	●	●
Seat-belts 3-point lap-sash (all seats)	●	●	●	●
Seat-belts (front) with pretensioners, load-limiters and height adjustable shoulder anchorages	●	●	●	●
Side impact door beams	●	●	●	●
Traction Control System (TCS)	●	●	●	●
'Triple H' safety construction with front and rear crumple zones	●	●	●	●

● Standard Feature - Not Available



'TAKUMI' A TRADITION OF MASTER CRAFTSMANSHIP

In Japan outstanding craftsmen are known as 'Takumi'. To reach this level, they must hone their craft over time by closely observing a master. In a way this learning never ends; they always aim for a higher level, to produce something truly exceptional. The superb skill of 'Takumi' is embodied by Japanese sword makers and calligraphers. Guided by tradition, their work is exacting, timeless and beautiful. At Mazda we know it's the skill of our people that allows us to reach the highest standards – so our engineers are fostered in one-on-one training for two years. That way each Mazda is crafted with the highest quality that can be imagined.

Rest assured - your warranty



Mazda CX-9 is backed up by a 3-year, unlimited kilometre factory warranty and 6-year panel protection warranty.

Maintain that Zoom-Zoom

Your Mazda CX-9 deserves the best in care. Servicing with Mazda Service Select gives your car the advantage of factory trained Service Technicians and advanced computer diagnostic systems. As well as maintaining your Mazda in A1 condition, you'll also be protecting your vehicle's outstanding resale value.



Help is at hand – Mazda Roadside Assistance

Flat batteries, running out of fuel and flat tyres are the kind of hiccups everyone faces from time to time. When the unexpected happens, Mazda Roadside Assistance is there to keep you moving. You'll be covered 24 hours a day, 365 days a year, all round Australia. Better still, your Mazda will only be worked on by Mazda-approved technicians. Choose a Standard policy offering everything required to get you going again, or the Premium policy with extra benefits such as accommodation, a rental car and vehicle recovery. Either policy can be purchased across the entire Mazda range. (Terms and conditions apply.)

Accessories add enjoyment

Mazda CX-9 spoils you with style and luxury. And Mazda Genuine Accessories make owning and driving one even more special. They let you personalise your vehicle and protect your investment. They also give you superb design, quality, fit and safety, all with the reassurance of a Mazda warranty. Mazda Genuine Accessories let you add even more Zoom-Zoom.

COLOURS

Exterior

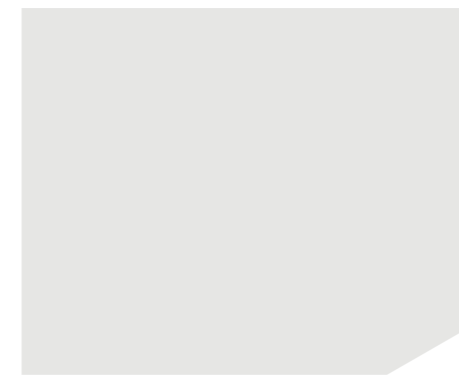

Crystal White Pearl ■ ▲
Mica



Aluminium ■ ▲
Metallic



Blue Reflex ■ ▲ ●
Mica



Zeal Red ■ ▲
Mica



Meteor Grey ■ ▲ ●
Mica



Jet Black ■ ▲ ●
Mica

Interior

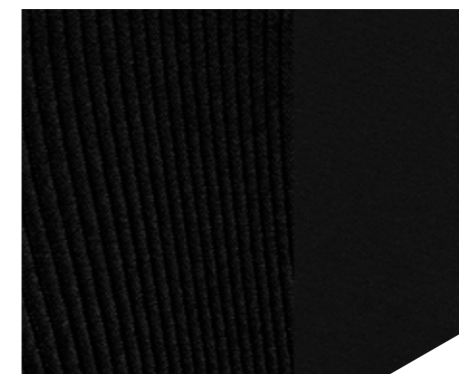

■ Black Cloth
Classic



▲ Black Leather³
Luxury and Grand Touring

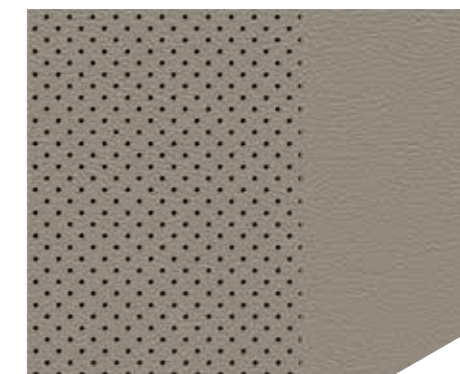

● Sand Leather³
Luxury and Grand Touring

All care is taken to ensure the accuracy of this brochure at the time of publication. Specifications, features and model availability may vary from State to State and may change without notice. Please refer to mazda.com.au or consult your Mazda Dealer prior to placing an order to ascertain current information on model availability, specifications, options, features and prices. Mazda Australia Pty Limited will not be liable for any loss arising from the information in this brochure, whether in negligence or otherwise. Mazda Australia Pty Limited ABN 78 004 690 804, 385 Ferntree Gully Road, Mt Waverley, Victoria 3149. iPhone® and accessories are shown for illustrative purposes only and do not come standard with the vehicle. iPhone® and iPod® are trademarks of Apple Inc., registered in the U.S. and other countries. Due to the nature of the printing process, colours may vary from those shown in this brochure. Ask your Dealer to show you a product sample.

1 Fuel consumption figures are based on ADR81/02 test results. They are useful in comparing the fuel consumption of different vehicles. They may not be the fuel consumption achieved in practice. This will depend on traffic and road conditions and how the vehicle is driven. 2 Please check the compatibility of your Bluetooth® device (particularly your mobile phone) with the specific Mazda vehicle you intend to purchase as not all devices operate correctly. Visit mazdahandsfree.com.au or consult your Mazda Dealer for further information. 3 Leather interior includes Maztex material on selected high impact surfaces. Sand leather interior only available with selected exterior colours. 4 Measured with 3rd row seats up and up to roof. 5 Measured with 3rd row seats folded down and up to roof. 6 Subject to State or Territory regulations.

Mazda CX-9 ACCESSORIES

ZOOM-ZOOM



MAKE YOUR MAZDA EVEN MORE ENJOYABLE

Mazda CX-9 spoils you with style and luxury. And Mazda Genuine Accessories can make the journey more rewarding than ever. They let you add a personal touch and protect your investment. Plus they give you superb design, quality, fit and safety, all with the reassurance of a Mazda warranty. Mazda Genuine Accessories let you add even more Zoom-Zoom.

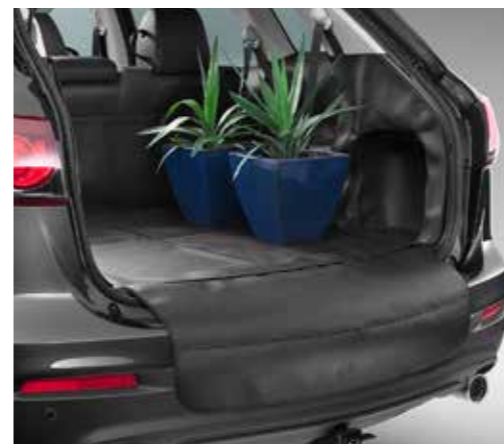

Cargo liner/rear bumper protector
Protect your cargo area from messy cargo or pet hair. (Liner & bumper protector sold separately.)



Bonnet protector (clear)
Guards against damage from stones and other debris.

Headlight protectors
Safeguards headlamp lenses against damage.



Boot lip protector
Protect your boot lip and bumper from scuffs and scratches whilst loading. Features reflective safety strip.



Bonnet protector (smoke)
Smoke finish lends a distinctive look.

Front parking sensors
Makes parking easier by sounding a warning when your front bumper nears an obstacle.



Cargo tray
Strong with raised sides, this cargo tray offers maximum protection against dirt, scratches and spills.



Cargo cover
Keep your valuable items out of sight. (Classic & Luxury only.)



Roof racks

Aerodynamically designed to reduce drag.
Load capacity of up to 75kg.

Slimline weathershields (set of 4 with chrome trim)

Let fresh air in - keep the worst of the weather out.



Tow bar

Designed specifically for Mazda CX-9, with a 2,000kg (braked)* capacity. (Tow ball sold separately.)

Reverse parking sensors

A warning tone helps prevent bumper damage by alerting you to obstacles.

zoom-zoom-zoom



Floor mats (front set)
Treat your feet and protect your carpet with these high quality, durable floor mats.



Floor mats (middle/rear)



Bike rack (wheel on)
Bring your other wheels along without having to remove one.



Cargo organiser box
Prevent items from sliding around in the load compartment. Features moveable interior dividers, detachable lids and a securable base.



Kayak holder
Convenient carrying of a canoe, kayak or similar-sized watercraft.



Collapsible sun screen
Keep your vehicle cool and protect the interior from the sun's harmful rays.



Mazda retractable audio cable (3.5mm male-to-male)
Allows portable audio devices to play via your vehicle's speakers, using the auxiliary jack.



Rear seat entertainment holder - for iPad®
A great way to entertain rear seat passengers. Tilts and rotates to allow landscape or portrait viewing. Includes an iPad® charger and headphones.



Ski/snowboard carrier
It's simple to get geared up for the snow.



Rear window shades
Protect passengers and cargo from the sun. The set covers both tailgate and/or rear passenger windows.



Audio retractable USB cable
Stream music and track data from your iPhone® or iPod® to the vehicle's audio system and multi information display. Also charges your device.

- Also available**
- ▶ Chrome tow ball and cover
 - ▶ Cigarette lighter

To see the full range of Mazda Genuine Accessories, go to **MAZDA.COM.AU**

All care is taken to ensure the accuracy of this brochure at the time of publication. Sports and other equipment shown in the brochure are for illustrative purposes only and do not come standard with the vehicle, or as Mazda Genuine Accessories. Specifications, features and availability may vary from State to State and may change without notice. Please refer to mazda.com.au or consult your Mazda Dealer prior to placing an order to ascertain current information on availability, specifications, features and prices. Mazda Australia Pty Limited will not be liable for any loss arising from the information in this brochure, whether in negligence or otherwise. Mazda Australia Pty Limited ABN 78 004 690 804, 385 Ferntree Gully Road, Mount Waverley, Victoria 3149. All Mazda Genuine Accessories fitted at the point of sale of a new Mazda passenger vehicle are covered under the Mazda 3-year/unlimited kilometre warranty. Mazda Genuine Accessories fitted after the sale of a new Mazda vehicle are covered by the Mazda 2-year or 40,000 kilometre warranty (whichever should occur first). iPod®, iPhone® and iPad® are trademarks of Apple Inc., registered in the U.S. and other countries. *Subject to State and Territory regulations. Consult your Mazda Dealer for further information. Published September 2013. MAZ10777 126.037



MX-5



Mazda 6



Mazda 3



BT-50



Mazda 2



CX-9



CX-5



Like us on the official Mazda Australia fan page for the latest pictures, videos, events, news and competitions. Ask questions, give feedback or upload your own photos. **Join the conversation at [facebook.com/mazdaaus](https://www.facebook.com/mazdaaus)**



Join the conversation on Twitter. Keep up with breaking Mazda news, videos and pictures from around the web. Tweet your questions, give feedback or post your own photos. **[twitter.com/mazdaaus](https://www.twitter.com/mazdaaus)**



Visit Mazda Australia's YouTube channel. You'll find video content with exclusive behind-the-scenes footage. **[youtube.com/zoomzoom](https://www.youtube.com/zoomzoom)**