

MAZDA MX-5



mazda













zoom-zoom



IMAGINATION DRIVES US



MX-5 Roadster Limited in Soul Red Metallic

	2 INTRODUCTION		14 CONNECTIVITY
	4 ALL-NEW MAZDA MX-5		16 SAFETY
	6 EXTERIOR		18-21 MODELS
	8 INTERIOR		22-25 SPECIFICATIONS
	10 DYNAMICS		26 CONFIDENCE
	12 PERFORMANCE & SKYACTIV TECHNOLOGY		27 COLOUR & TRIM

IMAGINATION DRIVES US

Imagination is the world's most valuable resource. It's our window to the future, because if we can imagine it, we can create it. Mazda is built on a foundation of imagination and ingenuity. It's the fuel behind all we create and achieve. It has given us SKYACTIV TECHNOLOGY, 'KODO – Soul of Motion' design and countless successes that once existed only in someone's imagination. These pages show how imagination is an integral part of our innovative cars.



MX-5 Roadster Limited in Soul Red Metallic

EXCITE EVERY SENSE

All-New Mazda MX-5 is Zoom-Zoom in its purest form. Lighter and more streamlined than ever, the All-New open top MX-5 brings car and driver together in a renewed spirit of 'Jinba Ittai' - the philosophy of 'horse and rider as one.' There's never been a more authentic expression of 'KODO - Soul of Motion' design. The lean, muscular body conveys power ready to be unleashed, balanced by a low stance that anchors it to the road. The interior is designed to feel like an extension of the driver, with an uncluttered, driver-focused layout to keep their world in control.

Enhanced with SKYACTIV TECHNOLOGY, MX-5's reputation for driving pleasure is heightened even further, with agile handling that responds with breathtaking reflexes. With a 26-year heritage as the world's most popular lightweight sports car, All-New Mazda MX-5 excites every sense like only a true roadster can. The iconic MX-5 is back, and more exhilarating than ever.



魂動

KODO : SOUL of MOTION

MX-5 Roadster Limited in Soul Red Metallic



DESIGNED FOR THE DRIVER

All-New MX-5 captures Mazda's signature KODO Design philosophy in its most exciting form with every angle and contour ready for action. It's the epitome of the 'driver's car,' with every element carefully designed to evoke the feeling of being at one with the vehicle.

Lowered by hand with one simple action, the soft-top glides seamlessly away from view for wind-in-the-hair exhilaration. When closed, the roof reinforces the striking shape of the vehicle, adding a more defined silhouette. Incorporating true sports car elements, its low stance conveys a striking road presence. The new body preserves the spirit of the previous three generations of MX-5, combined with a power and elegance that is only fully realised when it's complete with driver.



CAR AND DRIVER BECOME ONE

The interior blends the boundaries between the inside and the outside of the vehicle. The sleek design promotes a greater sense of connection to the open air, and oneness between car and driver. Interior panels enveloping the driver feature exterior paintwork for a sport-luxe finish to the cockpit. Understated, quality finishes feature throughout the cabin, with all controls intuitively positioned to surround the driver in symmetry for optimal driving position and comfort.

Everything about the uncluttered, driver-focused interior design has been considered to remove visual noise and maximise the driving pleasure of the authentic roadster experience.



MX-5 Roadster Limited in Soul Red Metallic

THE EVOLUTION OF JINBA ITTAI

Inspired by the Jinba Ittai philosophy of 'horse and rider as one,' the intuitive relationship between car and driver is felt in All-New MX-5's responsive handling. The new generation has experienced a significant weight loss, yet an increased sense of rigidity. An enhanced feeling of balance and control is a result of perfect 50:50 front-rear weight distribution. With a lowered centre of gravity and the engine brought closer to the vehicle's centre, you experience responsiveness and stability that makes for a supremely supple drive. All-New MX-5 is the purest embodiment of Jinba Ittai yet. The car becomes a true extension of the driver, responding with innate agility to every command.



MX-5 Roadster Limited in Soul Red Metallic

Breakthrough SKYACTIV TECHNOLOGY is behind MX-5's exhilarating, yet economical performance. The innovation is applied to every element of the vehicle, unlocking superior handling and better fuel efficiency.

SKYACTIV TECHNOLOGY

SKYACTIV-MT

The newly developed 6-speed SKYACTIV-MT manual transmission delivers a lively performance and superior fuel economy. As one of the world's lightest transmissions, it's helped keep MX-5's weight down.



SKYACTIV-CHASSIS

The development of the MX-5 SKYACTIV-CHASSIS was focused on achieving superior handling and stability, with faithful responses in every driving situation. The vehicle's posture has been crafted for flawless cornering, acceleration and braking to engage in a harmonious conversation with the open road.



SKYACTIV-G 1.5L

The new generation SKYACTIV-G petrol engine features direct injection with a unique piston design to promote more effective fuel combustion - boosting power, fuel economy and lowering emissions. Unleashing powerful performance with the feel of a broad torque range, the redesigned engine block delivers powerful acceleration well into the high RPM range, with a compression ratio of 13.0:1 when running on high-octane fuel.



SKYACTIV-G 2.0L

Developed to offer driving pleasure in all conditions, the SKYACTIV-G 2.0L engine delivers maximum torque with impressive fuel economy. The reduced weight and greater combustion efficiency means the driver gets an engine they can always count on in the high RPM range.



SKYACTIV-BODY

The new MX-5 SKYACTIV-BODY is assembled with materials explicitly selected to keep it light, yet rigid. Constructed from a combination of ultra-high-tensile steel and high-strength aluminium, the body is designed with integrity to be strong without bulk.

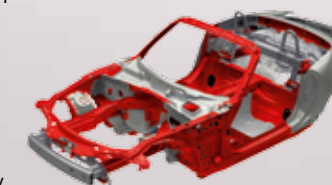

UNLEASH PURE PERFORMANCE

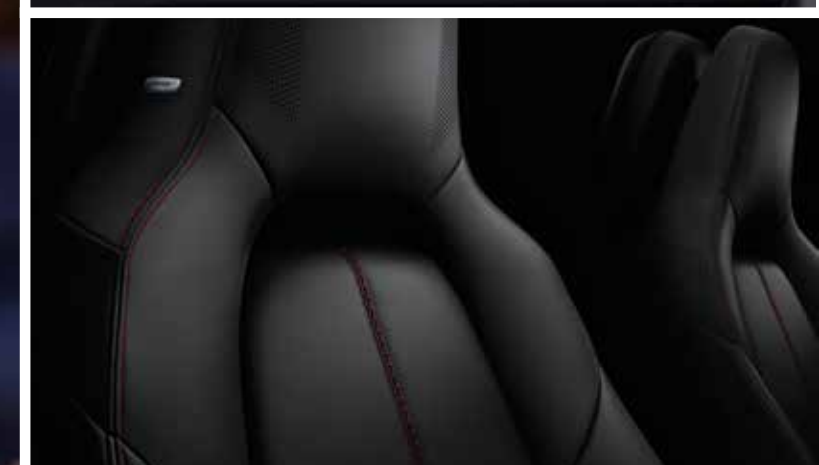

MX-5 Roadster Limited in Soul Red Metallic

THE CONTROL CENTRE OF YOUR DRIVING UNIVERSE

Multi-function commander control Conveniently located between the driver and passenger, the Multi-function commander allows safe operation of MZD Connect with minimal effort.

MZD Connect The All-New MX-5 is equipped with MZD Connect, a customisable on-board connectivity system that makes it safer and easier to access your online world on the road. Link your smartphone² via Bluetooth[®] to access your music, contacts and social networks from a single screen. Program it with your favourite information for an even more streamlined experience. Up-to-date maps mean navigation is never an issue, so you can relax and enjoy the drive.

Audio In addition to the standard-equipment six-speaker configuration, All-New MX-5 is also available with a premium nine-speaker Bose[®] sound system on Limited-grade models. Both configurations feature 45mm driver's side headrest speakers, with the Bose[®] audio system adding additional headrest speakers for the passenger and a subwoofer. Jointly developed with Bose[®], the exclusive system is designed to produce stunning sound quality, even with the top down. The USB and Bluetooth[®] compatible unit supports audio playback from iPods and other portable audio devices.



MX-5 Roadster Limited in Soul Red Metallic

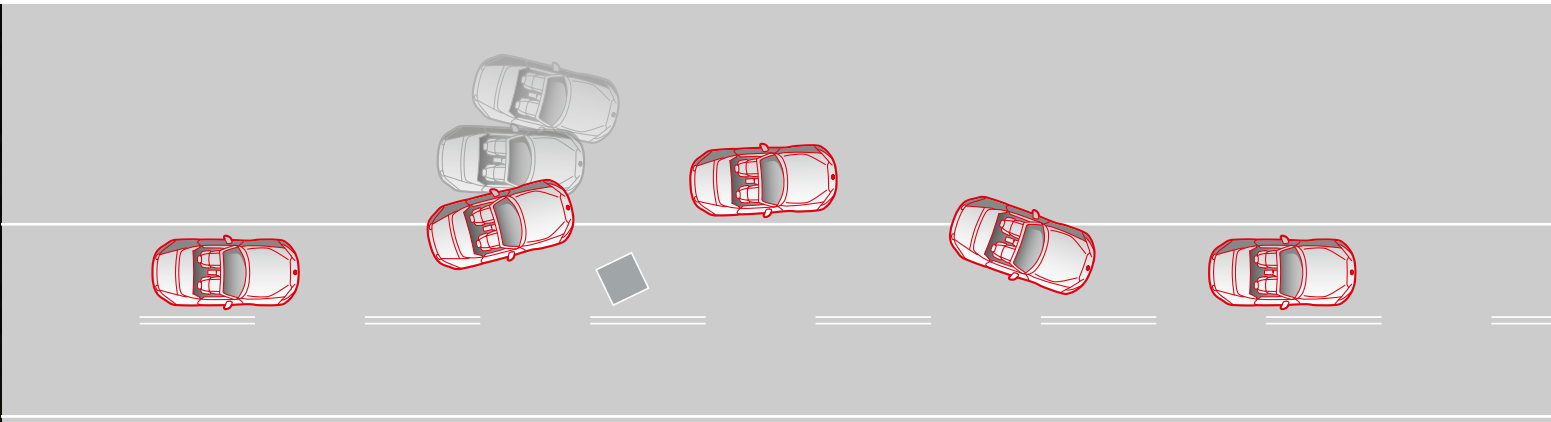

SAFETY REFLEX

Maintain control in an emergency braking situation with Dynamic Stability Control (DSC), which kicks in to assist steering. Traction Control System (TCS) limits skidding.

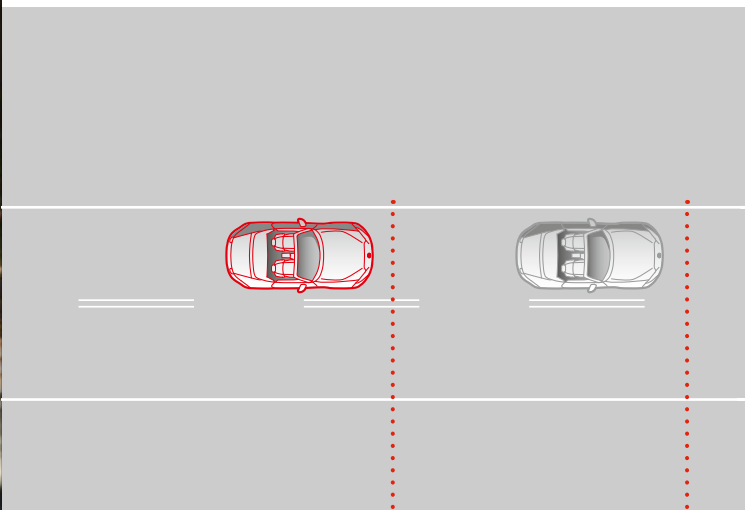

BETTER BRAKING

Stopping distance with EBA, ABS and EBD.

Stopping distance with no assistance.



INCLINES MADE EASY

Take your foot from the brake on a slope and Hill Launch Assist (HLA) is activated, keeping the brake on briefly and giving you time to apply the accelerator for a smooth take-off.

DRIVE WITH CONFIDENCE

Development of All-New MX-5 focused on creating an exhilarating drive, while also maximising safety and driver peace of mind. The high-strength SKYACTIV-BODY is engineered to minimise harm in the event of a collision. Front airbags for both passengers come as standard, and side-airbags with head-protecting cells safeguard against impact even with the top down.

ABS brakes feature Electronic Brake-force Distribution (EBD), which matches braking to vehicle load, while Emergency Brake Assist (EBA) boosts stopping power when emergency braking is sensed. An Emergency Stop Signal (ESS) activates the hazard lights to warn following drivers of sudden deceleration. And on SKYACTIV-MT manual models, Limited-Slip Differential (LSD) applies equal torque to both wheels, minimising wheel-spin. Armed with the latest in safety aids, you can enjoy every thrilling drive with confidence.

1.5L ROADSTER GSX



1.5L Roadster GSX in Crystal White Mica.



1.5L Roadster GSX 6-Speed Manual

1.5L ROADSTER GSX FEATURES INCLUDE:

- 16-inch alloy wheels with 195/50 tyres
- Cloth soft-top
- Daytime running lights (LED)
- Headlamps (LED)
- Power mirrors (body coloured)
- Seat trim: black cloth
- Air-conditioning
- Cruise control
- Leather-wrapped: steering wheel, handbrake handle and gear shift knob
- Trip computer³
- 7-inch touchscreen display (MZD Connect)
- Internet radio integration (Pandora,[®] Stitcher[™] and Aha[™])
- Multi-function commander control
- Bluetooth[®] hands-free phone and audio capability²

- Keyless entry with keyless push-button ignition
- Steering wheel-mounted audio controls
- USB-audio input port (iPod compatible)
- Airbags SRS: front (driver and passenger) and side
- Dynamic Stability Control (DSC)
- Emergency Stop Signal (ESS)
- Hill Launch Assist (HLA)
- Limited Slip Differential (SKYACTIV-MT only)
- Tyre Pressure Monitoring System (TPMS)
- i-ACTIVSENSE safety technologies⁴:
 - Blind Spot Monitoring (BSM)
 - Rear Cross Traffic Alert (RCTA)

ACCESSORY OPTION:

- Satellite Navigation

POWERTRAIN:

- 1.5 litre in-line 4 cylinder 16 valve DOHC S-VT petrol (SKYACTIV-G) engine
- Transmission: 6-speed manual (SKYACTIV-MT)
- Drivetrain: RWD
- Max power: 96kW @ 7,000rpm
- Max torque: 150Nm @ 4,800rpm
- Fuel consumption (combined)¹: 6.1 l/100km (manual)



SPORTING ALLURE

16-inch alloy wheels (silver) are the ultimate in stripped-back, functional beauty.



BE SEEN

LED Daytime Running Lamps make you more visible to other drivers.



ALL AT YOUR FINGERTIPS

MZD Connect offers touchscreen connectivity and a large screen for easy viewing.



SET THE PACE

Cruise Control maintains a consistent speed for a comfortable drive that can also save you fuel.

2.0L ROADSTER LIMITED[^]



MX-5 Roadster Limited in Blue Reflex Mica



2.0L Roadster Limited 6-Speed Automatic in Soul Red

2.0L ROADSTER LIMITED FEATURES ADDITIONAL TO 1.5L ROADSTER GSX INCLUDE:

- 17-inch bright silver alloy wheels with 205/45 tyres
- Headlamps auto on/off function
- Power mirrors (body coloured with heating function)
- Rain-sensing wipers
- Seat trim: black leather⁵ with red stitching
- Front seats with: heating function
- Auto-dimming rear-view mirror
- Climate control air-conditioning
- Premium Bose[®] 203 watt amplifier with 9 speakers
- Satellite navigation
- Keyless entry (advanced proximity)
- Paddle shift gear control (AT only)
- Drive selection with sport mode (AT only)
- i-ACTIVSENSE safety technologies⁴:
 - Lane Departure Warning (LDW)
 - High Beam Control (HBC)

POWERTRAIN:

- 2.0 litre in-line 4 cylinder 16 valve DOHC S-VT petrol (SKYACTIV-G) engine
- Transmission: 6-speed manual (SKYACTIV-MT) or 6-speed automatic
- Drivetrain: RWD
- Max power: 118kW @ 6,000rpm
- Max torque: 200Nm @ 4,600rpm
- Fuel consumption (combined)¹: 6.9 l/100km (manual), 7.1 l/100km (automatic)

[^]On sale from January 2016



EXCITEMENT FROM THE GROUND UP

17-inch alloy wheels (bright silver) are the ultimate example of beauty in simplicity, enhancing MX-5's sleek sports aesthetic.

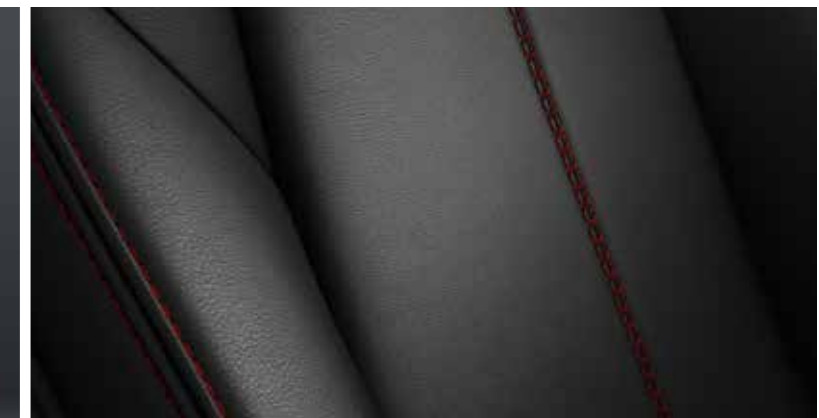

CRAFTED FOR QUALITY

Black leather⁵ seat trim adds cool elegance with quality craftsmanship and KODO diamond-shaped stitching.



MAKE SOME NOISE

Jointly developed with Bose[®] the premium audio system with 9 speakers includes headrest speakers and is designed to produce stunning sound quality even with the top down.



WHERE TO NEXT?

Relax and enjoy the drive with Satellite Navigation that's mapped out the journey for you.

SPECIFICATIONS

Powertrain		1.5L I4 Petrol	2.0L I4 Petrol
Bore and stroke (mm)		74.5 x 85.8	83.5 x 91.2
Compression ratio		13.0 : 1	13.0 : 1
Drivetrain		RWD	RWD
Emissions standard		Euro stage V	Euro stage V
Engine capacity (cc)		1,496	1,998
Engine type		1.5 litre in-line 4 cylinder 16 valve DOHC S-VT petrol (SKYACTIV-G) engine	2.0 litre in-line 4 cylinder 16 valve DOHC S-VT petrol (SKYACTIV-G) engine
Fuel consumption (l/100km):	Manual (combined)	6.1	6.9
	Auto (combined)	-	7.1
Fuel system		----- Electronic direct injection -----	
Fuel tank capacity (litres)		45	45
Gear ratio - Manual/Auto:	1st	5.087 / -	5.087 / 3.538
	2nd	2.991 / -	2.991 / 2.060
	3rd	2.035 / -	2.035 / 1.404
	4th	1.594 / -	1.594 / 1.000
	5th	1.286 / -	1.286 / 0.713
	6th	1.000 / -	1.000 / 0.582
	Reverse	4.696 / -	4.696 / 3.168
	Final drive	2.866 / -	2.866 / 3.454
Maximum power (kW @ rpm)		96 @ 7,000	118 @ 6,000
Maximum torque (Nm @ rpm)		150 @ 4,800	200 @ 4,600
Recommended fuel		Premium unleaded (95RON or higher)	Premium unleaded (95RON or higher)
Throttle control		----- Electronic (drive-by-wire) -----	
Transmission:	Manual	6-speed (SKYACTIV-MT)	6-speed (SKYACTIV-MT)
	Automatic	-	6-speed

Model Availability		Roadster GSX	Roadster Limited
2-seat Convertible:	1.5L I4 Petrol RWD / 6-speed manual	●	-
	2.0L I4 Petrol RWD / 6-speed manual	-	●
	2.0L I4 Petrol RWD / 6-speed automatic	-	●

Chassis		Roadster GSX	Roadster Limited
Brake diameter (mm):	Front	258	280
	Rear	255	280
Brake type:	Front	----- Ventilated disc -----	
	Rear	----- Solid disc -----	
Steering type		----- Double-pinion electric power assist steering -----	
Suspension:	Front	----- Double wishbone -----	
	Rear	----- Multi-link -----	
Turning circle kerb to kerb (m)		9.4	9.4
Tyre size	1.5L I4 Petrol RWD	195/50 R16	-
	2.0L I4 Petrol RWD	-	205/45 R17
Tyre index	1.5L I4 Petrol RWD	84V	-
	2.0L I4 Petrol RWD	-	84W
Wheel size	1.5L I4 Petrol RWD	16 X 6.5 J	-
	2.0L I4 Petrol RWD	-	17 x 7.0 J
Wheel type		Alloy	Alloy (Bright Silver)

Weight and Capacities		Roadster GSX	Roadster Limited
Cargo room volume (litres)		130	130
Kerb weight (kg):	1.5L I4 Petrol RWD / 6-speed manual	1,009	-
	2.0L I4 Petrol RWD / 6-speed manual	-	1,033
	2.0L I4 Petrol RWD / 6-speed automatic	-	1,057

Dimensions		Roadster GSX	Roadster Limited
Ground clearance unladen (mm)	1.5L I4 Petrol RWD	140	-
	2.0L I4 Petrol RWD	-	150
Overall length (mm)		3,915	3,915
Overall width (mm)		1,735	1,735
Overall height (mm)		1,225	1,230
Track (mm):	Front	1,495	1,495
	Rear	1,505	1,505
Wheelbase (mm)		2,310	2,310

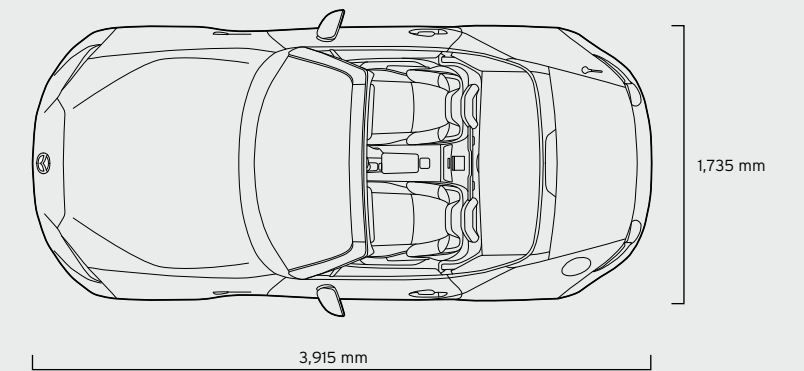
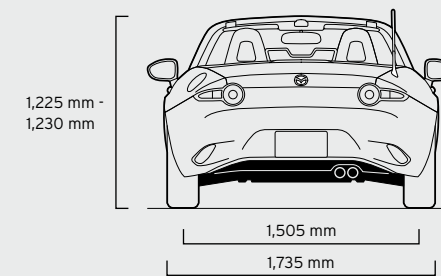
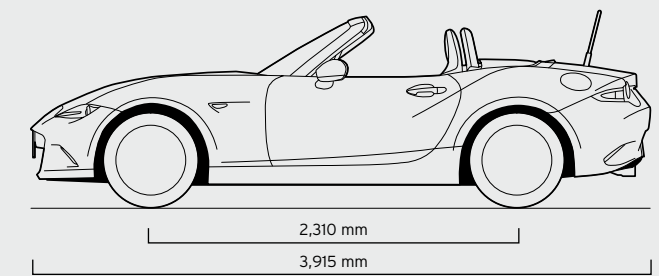
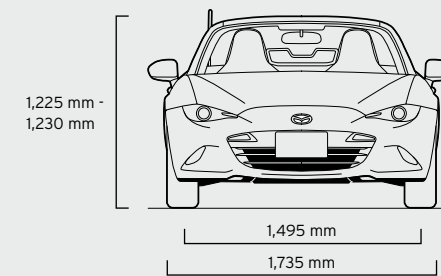

SPECIFICATIONS

Exterior	Roadster GSX	Roadster Limited
Daytime running lights (LED)	●	●
Door handles (body coloured)	●	●
Dual exhausts (chrome-finish)	●	●
Front and rear bumpers (body coloured)	●	●
Green-tinted windscreen, side and rear windows	●	●
Headlamps (LED)	●	●
Headlamps auto on/off function	-	●
Power mirrors	●	-
Power mirrors with heating function	-	●
Power windows	●	●
Soft-top (cloth)	●	●
Tail-lamps (LED)	●	●
Window demister (rear)	●	●
Wipers (front) 2-speed with rain-sensing function	-	●
Wipers (front) 2-speed with variable intermittent function	●	-

Seats	Roadster GSX	Roadster Limited
Front seats with:	Heating function	-
	Rake and incline slide adjustment	●
	Tilt adjustment (driver)	●
Seat trim:	Black cloth	●
	Black leather ⁵	-

Interior	Roadster GSX	Roadster Limited
Air-conditioning	●	-
Air-conditioning (climate control)	-	●
Ambient temperature display	●	●
Critical function warning lights/chimes	●	●
Cruise control	●	●
Cupholders	●	●
Drive selection	-	● [^]
Instrument panel light dimmer	●	●
Interior illumination:	Entry system with delayed fade	●
	Map reading spot lamps	●
	Power window switch	●
Leather-wrapped:	Gear shift knob	●
	Handbrake handle	●
	Steering wheel	●
One touch (down) power windows	●	●
Paddle shift gear control	-	● [^]
Puncture repair kit	●	●
Rear-view mirror with auto dimming function	-	●
Tachometer and electronic odometer/tripmeter	●	●
Tilt adjustable steering wheel	●	●
Trip computer ³	●	●
Vanity mirrors	●	●

● = Standard, ●[^] = Standard (6-speed automatic only), - = Not available

Infotainment	Roadster GSX	Roadster Limited
7-inch full colour touch screen display (MZD Connect)	●	●
AM/FM tuner	●	●
Auxiliary-audio input jack (3.5mm mini-stereo)	●	●
Bluetooth® hands-free phone and audio capability ²	●	●
Internet radio integration (Pandora® Stitcher™ and Aha™)	●	●
Multi-function commander control	●	●
Premium Bose® 203 watt amplifier and speakers	-	●
Radio Data System (RDS) program information	●	●
Satellite navigation	○	●
Speakers (6)	●	-
Speakers (9)	-	●
Steering wheel-mounted audio controls	●	●
USB-audio input port (iPod compatible)	●	●
Voice activation and control	●	●

Safety and Security	Roadster GSX	Roadster Limited
Airbags SRS:	Front (driver and passenger)	●
	Side	●
Anti-lock Braking System (ABS)	●	●
Blind Spot Monitoring (BSM) ⁴	●	●
Dynamic Stability Control (DSC)	●	●
Electronic Brake-force Distribution (EBD)	●	●
Emergency Brake Assist (EBA)	●	●
Emergency Stop Signal (ESS)	●	●
Engine immobiliser	●	●
High Beam Control (HBC) ⁴	-	●
High mount stop lamp	●	●
Hill Launch Assist (HLA)	●	●
Intrusion-minimising brake pedal	●	●
Keyless entry	●	-
Keyless entry (advanced proximity)	-	●
Keyless push-button engine start	●	●
Lane Departure Warning (LDW) ⁴	-	●
Limited-Slip Differential (LSD)	●*	●*
Rear Cross Traffic Alert (RCTA) ⁴	●	●
Seat-belts 3-point lap-sash	●	●
Seat-belts (front) with pretensioners and load-limiters	●	●
Seat-belt warning	●	●
Side impact door beams	●	●
Traction Control System (TCS)	●	●
Tyre Pressure Monitoring System (TPMS)	●	●

● = Standard, ○ = Option, ●* = Standard (6-speed manual only), - = Not available.

ENJOY MAZDA MX-5 WITH CONFIDENCE

ENJOY MAZDA MX-5 COLOUR AND TRIM

mazdacare is a comprehensive programme designed to make owning your new Mazda passenger vehicle as worry-free as possible. You will appreciate the back-up and motoring support offered through Mazda On Call. We know you will enjoy the advantage and ease of the mazdacare Scheduled Service Programme that comes standard with your new Mazda passenger vehicle, and you will be impressed with our 5 year/unlimited km Warranty⁷.

3 year/100,000km Service at no additional cost⁸

We know you will enjoy the advantage and ease of the mazdacare Scheduled Service Programme that comes standard with your new Mazda passenger vehicle. Regular servicing is beneficial, keeping your Mazda in great shape for longer, saving you money in fuel, parts and keeping your vehicle safer on the road. That's why we offer 3 years or 100,000km (whichever occurs first) of mazdacare Genuine Mazda Scheduled Servicing at no extra cost. Each service is carried out by Mazda factory trained Service Specialists using the latest in vehicle diagnostic equipment, in order to keep every Mazda operating at optimum driving performance and help protect your investment in a car that enjoys excellent resale value.

5 year/unlimited km Roadside Assistance⁶

You will appreciate the back-up and motoring support offered through Mazda On Call. If something goes wrong when you're travelling then we're here to help. Mazda On Call is a Roadside Assistance programme available to Mazda owners 24-hours a day, 365 days a year - included as part of your mazdacare cover. So, if you run out of fuel, lock your keys in the car, all you need to do is call 0800 800 626. Our support centres are ready to help out with any mechanical, medical and even legal advice you might need.

5 year/unlimited km New Passenger Vehicle Warranty⁷

You'll be grateful for the peace of mind that comes with the 5 year, unlimited kilometre manufacturer's warranty⁷

- 5 year/unlimited km New Vehicle Warranty⁷
- 5 year/unlimited km corrosion and anti-perforation warranty



For more information on mazdacare, go to mazda.co.nz/mazdacare



Driving enjoyment has an exciting future

We're working hard to make driving a Mazda even more rewarding. With cars that use less fuel, but produce more power. That are lighter, but contain more innovation. We call this breakthrough SKYACTIV TECHNOLOGY. It will let every Mazda deliver more driving pleasure while being kinder to the planet. Find out more at mazdaskyactiv.co.nz

Soul shines through.

A paint finish created for KODO
 'KODO - Soul of Motion' is the dynamic design vision shaping the Mazda range. To bring these striking shapes to life we developed a special paint technology, TAKUMI-NURI. The Soul Red Metallic finish combines an enhanced reflective treatment with high-chroma pigment to achieve stunningly vivid depth and contrast.

Accessories add enjoyment

MX-5 gives you sports performance and impressive features. And with Mazda Genuine Accessories, MX-5 ownership is even more enjoyable. They allow you to personalise your car, and protect your investment. What's more, they deliver superb design, quality and safety, all backed by a Genuine Mazda Warranty. Mazda Genuine Accessories give you even more Zoom-Zoom.

BODY COLOURS



Crystal White Pearl Mica

Ceramic Metallic

Blue Reflex Mica



Soul Red Metallic*

Meteor Grey Mica

Jet Black Mica

INTERIOR TRIMS



Black Cloth (GSX)

Black Leather⁵ (Limited)

¹Combined fuel consumption figures are based on ADR 81/02 test results. They are useful in comparing the fuel consumption of different vehicles. They may not be the fuel consumption achieved in practice. This will depend on traffic and road conditions and how the vehicle is driven. ²Please check the compatibility of your Bluetooth® device (particularly your mobile phone) with the specific Mazda vehicle you intend to purchase as not all devices operate correctly. Visit mazdahandsfree.co.nz or consult your Mazda dealer for further information. ³Trip computer displays current and average fuel consumption, distance to empty and average vehicle speed. ⁴i-ACTIVSENSE safety technologies are driver assist technologies only and should not be used in place of skilled and safe driving practices. It is the driver's sole responsibility to constantly monitor vehicle surroundings and conditions at all times. ⁵Leather interior includes Maztex material on selected high impact surfaces. ⁶Your mazdacare support programme is effective from the first day of vehicle registration. ⁷The 5 Year New Passenger Warranty programme comprises a 3 year/unlimited km bumper-to-bumper factory warranty and a comprehensive Major Component and Safety System warranty for an additional 2 years/unlimited km. Therefore the total new vehicle warranty period is 5 years/unlimited km. ⁸Mazda New Zealand covers all routine service maintenance costs including Parts, Lubricants and Labour for the duration of the programme when service is performed by an authorised Mazda dealer. Visit mazda.co.nz/passenger-vehicle-warranty to see full disclosure of items covered by the 5 year/unlimited km New Passenger Vehicle Warranty.

*Surcharge Applies

All care is taken to ensure the accuracy of this brochure at the time of publication. Specifications, features and model availability may vary from Dealer to Dealer and may change without notice. Please refer to mazda.co.nz or consult your Mazda Dealer prior to placing an order to ascertain current information on model availability, specifications, options, features and prices. Mazda Motors of New Zealand Limited will not be liable for any loss arising from the information in this brochure, whether in negligence or otherwise. Mazda Motors of New Zealand Limited, PO Box 132057, Sylvia Park, Auckland 1644. Due to the nature of the printing process, colours may vary from those shown in this brochure. Ask your Dealer to show you a product sample prior to placing an order. Published August 2015. MZ4900560



mazda

ZOOM-ZOOM



Like us on the official Mazda New Zealand fan page for the latest pictures, videos, events, news and competitions. Ask questions, give feedback or upload your own photos. Find us by searching "Mazda NZ" on Facebook now.



Join the conversation on Twitter. Keep up with breaking Mazda news, videos and pictures from around the web. Tweet your questions, give feedback or post your own photos. Follow us today at @MazdaNZ



Visit Mazda New Zealand's YouTube channel. You'll find video content with exclusive behind-the-scenes footage. Find us by searching "Mazda NZ" on YouTube now.

Published August 2015. MZ4900560

For further information visit mazda.co.nz