



MAZDA CX-3

We explore cities and winding country roads.

Corners hugged and throttles revved.

Windows down, radio loud, no particular place to go.

Always forward, defying the wind.

I am the embodiment of Jinba Ittai.

You, the heart behind the wheel.

We were always meant to connect,

like a horse and rider,

car and driver as one.

Together, we are stronger.

We have a bond that words alone cannot describe.

We never drive alone.

We drive together.





MODEL SHOWN IS MAZDA CX-3 121PS 2WD SPORT NAV+ WITH OPTIONAL SOUL RED CRYSTAL METALLIC PAINT, AVAILABLE AT ADDITIONAL COST



MODEL SHOWN IS MAZDA CX-3 150PS AWD SPORT NAV+ WITH OPTIONAL SOUL RED CRYSTAL METALLIC PAINT, AVAILABLE AT ADDITIONAL COST

AWAKEN THE DRIVER IN YOU

When you drive a Mazda, you never drive alone. The feeling of togetherness, which we call Jinba Ittai, runs deep in the Mazda CX-3. Designed with a human-centric approach offering superior craftsmanship, coupled with innovative Skyactiv Technology that improves responsiveness and heightens driving pleasure, we aim to build an enduring relationship between car and driver. It's the Mazda Way.



Download
DRIVE TOGETHER APP



Scan Pages
CONTAINING THE MOBILE ICON



Explore
DIGITAL CONTENT

Enjoy Mazda's new DriveTogether App and get extra information on how our latest features can make your driving experience more enjoyable. All you have to do is download our Drive Together app on the AppStore or Google play. Look out for the mobile phone icon inside this brochure and scan it using the Drive Together app.



DESIGN







MODEL SHOWN IS MAZDA CX-3 121PS 2WD SPORT NAV+ WITH OPTIONAL SOUL RED CRYSTAL METALLIC PAINT, AVAILABLE AT ADDITIONAL COST



GRAB THE WHEEL

The Mazda CX-3's award-winning Kodo: Soul of Motion design gives the car the looks of a strong and stylish compact SUV that stands out from the crowd. Created by Mazda master craftsmen and designers, who carve designs out of clay, they sculpt and breathe life into each line and curve. The side profile features a powerful front-to-rear flow design, whilst the front of the car features a bold radiator grille and piercing headlamp design which provides the car with its imposing stance. Its impressive presence is endorsed by the craft of Takumi-Nuri, Mazda's high-quality painting technology, which makes the Kodo design come alive, reflecting light and shadows off of every line. Takumi-Nuri balances the depth and glossiness of the paint to give the impression of a hand-painted concept car. That is what makes the signature Soul Red Crystal and Machine Grey premium colours come to life.





MODEL SHOWN IS MAZDA CX-3 150PS AWD SPORT NAV+ AUTO WITH OPTIONAL SOUL RED CRYSTAL METALLIC PAINT, AVAILABLE AT ADDITIONAL COST

A TRUE DRIVING EXPERIENCE

There's so much more beyond the eye-catching looks of the Mazda CX-3. The position of the controls, the weight of the steering and the tension of the chassis work together to ensure you enjoy every element of the car. Superior levels of craftsmanship and fine attention to detail make the human-centric interior a wonderful place to be, with front and rear armrests adding to the levels of comfort. An array of materials used to build the Mazda CX-3 add to the senses, from cool-to-the-touch Satin Chrome detailing on the dashboard and door panels, to the feel of the soft leather trimmed steering wheel. Piece by piece, the Mazda CX-3 is a blend of luxury and comfort that contributes to the feeling of excitement that you experience every time you step inside.



HUMAN-CENTRIC INTERIOR



POWERFUL LED HEADLAMPS



18" SILVER ALLOY WHEELS

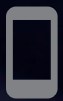

STONE LEATHER TRIM AVAILABLE AT ADDITIONAL COST ON SPORT NAV+ PETROL MODELS (ONLY IN COMBINATION WITH SAFETY PACK)

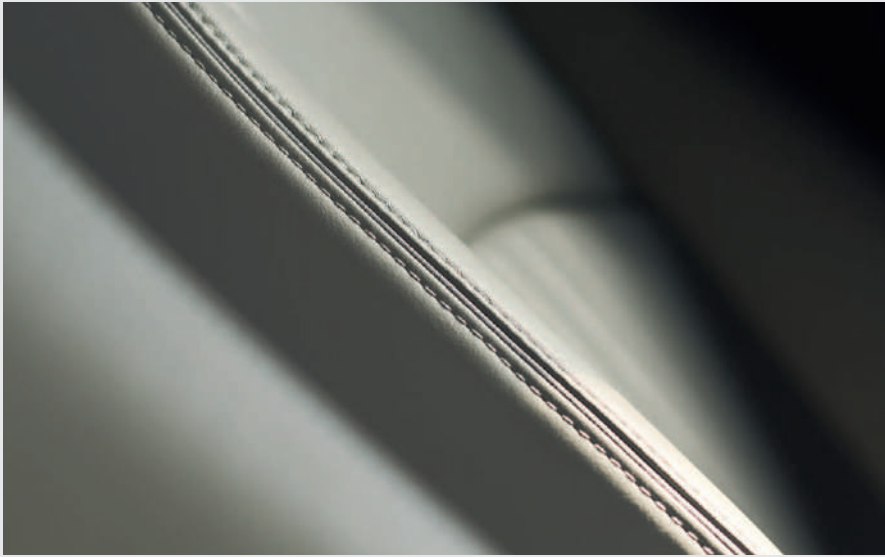

SUPERIOR CRAFTSMANSHIP



CLIMATE CONTROL AIR-CONDITIONING

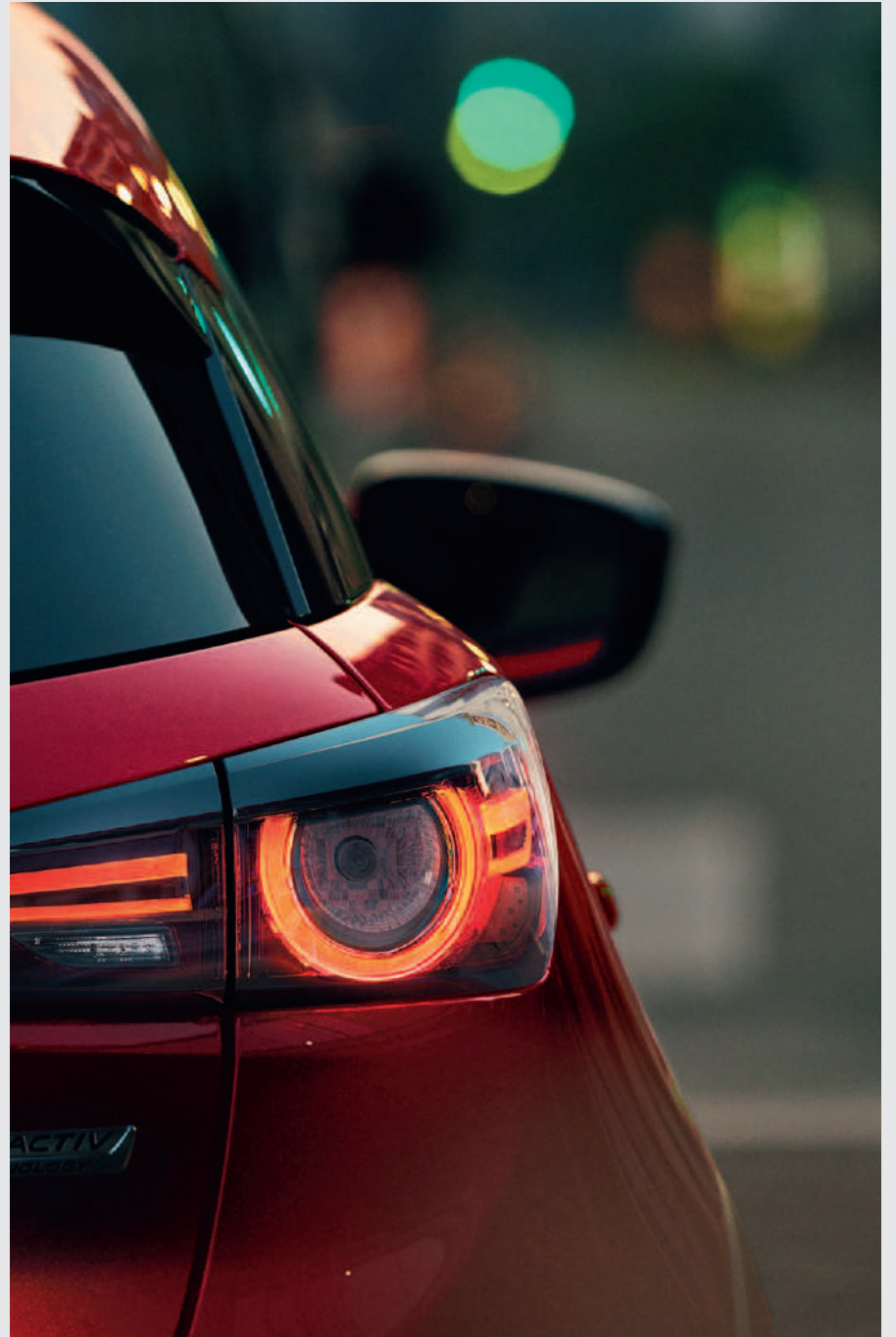

LED SIGNATURE REAR LIGHTS



The background is a dark, almost black, space. On the left side, there are several glowing, curved lines that appear to be part of a larger, unseen structure. These lines have a soft, white-to-gray gradient and a slight glow. In the background, there is a faint, dark grid pattern, suggesting a digital or technical environment. The overall aesthetic is futuristic and minimalist.

TECHNOLOGY

BE IN CHARGE

Connectivity is key in the Mazda CX-3 and via a compatible mobile device, you can access thousands of internet radio stations from around the world, safely check and reply to text messages, and even keep up-to-date with Facebook® and Twitter®*. Enjoy listening to your favourite radio stations via DAB radio or stream your choice of music via Bluetooth® connection*. All safely controlled using the 7" colour touch-screen display and the intuitive Multimedia Commander.

*With compatible mobile device. Data usage and costs will vary.
Please refer to the footnote underneath the Audio and Communication specification table.





Colour Active Driving Display with Traffic Sign Recognition

Projects essential driving information including speed, turn by turn navigation, key traffic signs and emergency warnings via a colour head-up display located near the driver's line of sight. (Available on Sport Nav+ models only)



BOSE® Sound System

The sensational Bose® surround-sound system was specifically designed for the Mazda CX-3. Featuring seven precisely positioned high-performance speakers that envelop you in a rich, spacious sound experience to keep you entertained on every drive. (Available on Sport Nav+ models only)



Leather Detailing

The premium feel of crafted leather in the palm of your hand creates yet another memorable connection between you and your Mazda CX-3.



Multimedia Commander

Located between driver and front passenger, the Multimedia Commander allows you to operate the infotainment and connectivity system with minimal effort. It includes a separate volume dial for easy adjustment, ensuring you can concentrate on enjoying the drive.

SKYACTIV TECHNOLOGY

Skyactiv Technology is all about making driving more fun, embracing all elements – engines, transmissions, chassis and body – it's an approach that completely reimagines the car from the ground up. The Mazda CX-3's light, rigid body coupled with the Skyactiv-Chassis and Mazda's G-Vectoring Control, work together to combine great responsiveness with precise and comfortable handling. This is complimented with the latest range of Skyactiv engines which deliver high torque, clean emissions and impressive fuel economy. We work hard to ensure there is zero compromise when it comes to Mazda's unique fun-to-drive feeling.



Integrating control of the engine, transmission, chassis and body, G-Vectoring Control provides the optimum load on each tyre during cornering, meaning the car moves exactly as the driver expects.



SKYACTIV ENGINES

Choose the acclaimed Skyactiv-G petrol engine available in 2.0 121ps 2WD and 150ps AWD power outputs, both offering a responsive and refined drive. Or for greater torque and fuel economy, choose the equally impressive 1.8 Skyactiv-D clean diesel engine, available in 115ps power output.

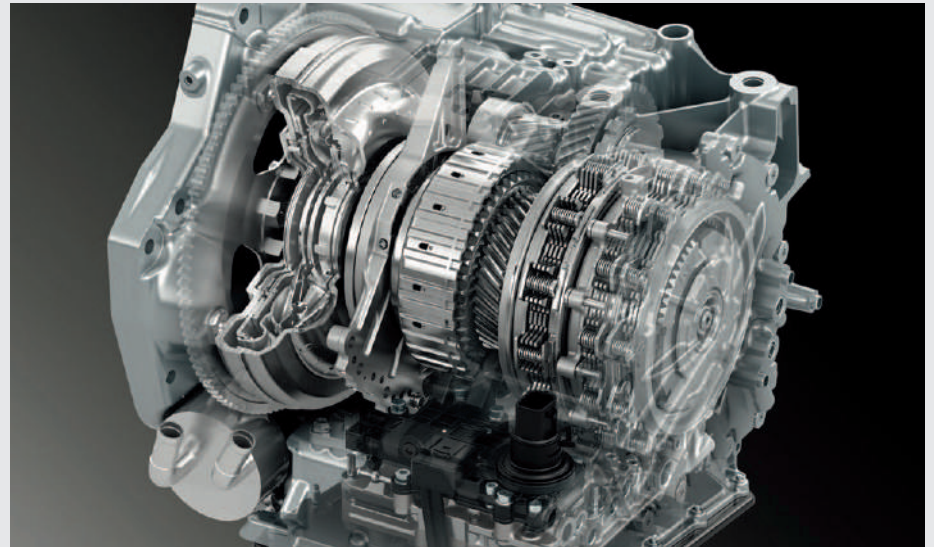

MORE POWER TO YOUR WHEELS

Supporting driving pleasure, the six-speed Skyactiv-Drive automatic transmission responds instantly providing a smooth drive, whilst the six-speed Skyactiv-MT manual transmission offers a crisp and responsive shift reminiscent of the legendary Mazda MX-5.



PRECISE AND COMFORTABLE HANDLING

The lightweight Skyactiv-Chassis provides exceptional handling and ride comfort. Coupled with steering which responds predictably to driver input, it delivers that 'fun to drive' element that has come to be expected from every Mazda we build.

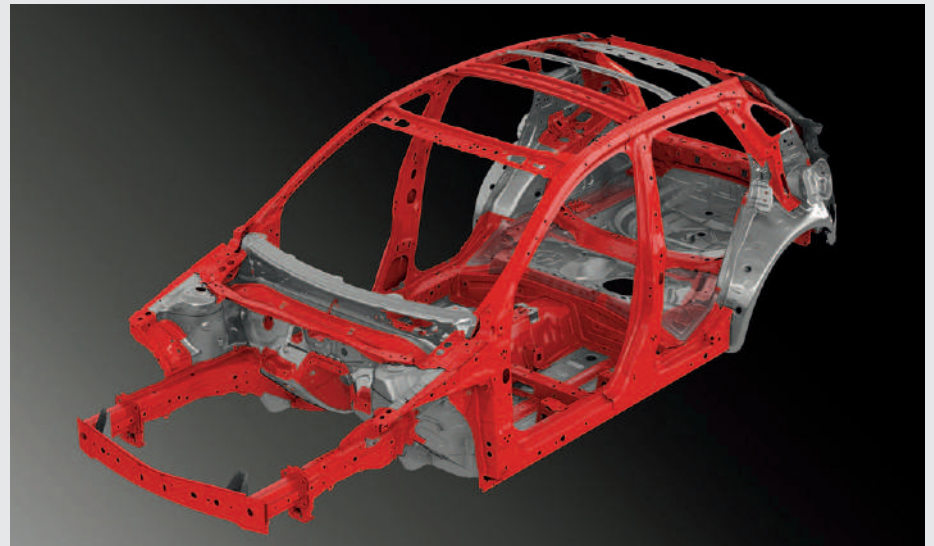

SKYACTIV-BODY

Outstanding crash protection is possible thanks to the Skyactiv-Body which utilises lightweight, high-tensile steel resulting in a highly rigid body. This contributes to impressive fuel economy and a more rewarding and responsive drive.

IT'S ALL ABOUT THE DRIVER

Mazda CX-3 contains an array of intelligent safety technologies that are designed to help you connect with your car and enjoy the drive. This is thanks to the i-Activsense technologies, an outstanding collection of safety features that use sensors and cameras to monitor your surroundings providing protection and convenience.





MODEL SHOWN IS MAZDA CX-3 150PS AWD SPORT NAV+ AUTO WITH OPTIONAL SOUL RED CRYSTAL METALLIC PAINT, AVAILABLE AT ADDITIONAL COST

ADVANCED SAFETY TECHNOLOGY

Engineered from the ground up, the Mazda CX-3 provides comprehensive all-round protection for you and your passengers. An array of active safety systems work together to warn you of impending dangers, meaning less chance of a collision. Whilst the front, side and curtain airbags combined with a rigid Skyactiv-Body, provide outstanding crash protection ensuring that you and your passengers remain safe.

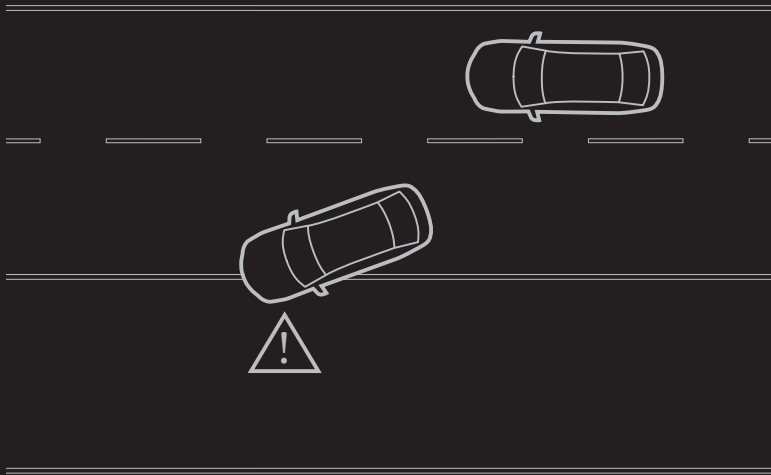

Lane Departure Warning System

Mazda's Lane Departure Warning System is designed to prevent your vehicle from inadvertently straying from its lane. A front-view camera monitors the road ahead and calculates the car's position relative to the lane markings. If the system detects the vehicle is moving out of its lane unintentionally, an audible alert will sound. (Not available on SE Nav+ models)

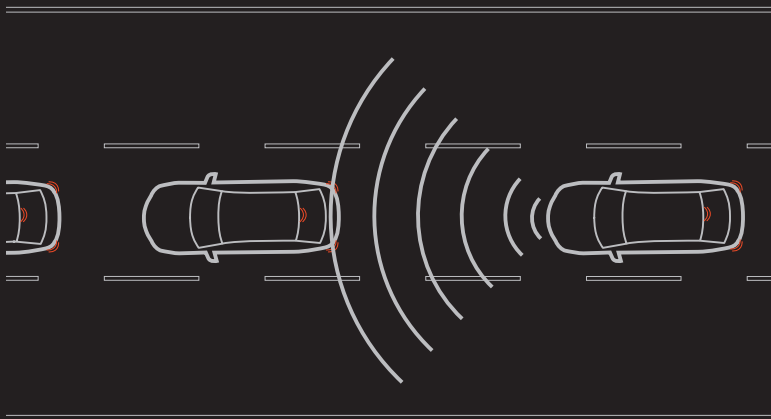

Advanced Smart City Brake Support

Designed for busy city traffic, Advanced Smart City Brake Support is designed to help avoid or minimise the effects of collisions at speeds up to approximately 50mph. The forward-facing camera and laser-based system continually monitors the gap and closing speed of the vehicle in front, and applies the brake if a collision is likely. (Not available on SE Nav+ models)



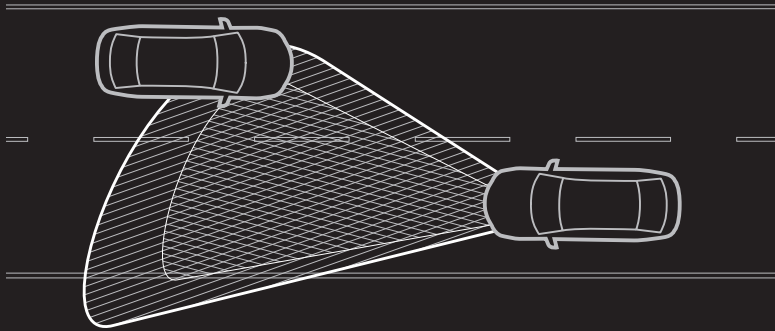

Adaptive LED Headlights

Designed to work at night, the system automatically analyses vehicles ahead or those approaching in the opposite direction, and automatically adjusts between high and low beams by switching LED bulbs on and off as necessary. This makes it possible to drive with the high beam on at all times, significantly improving visibility when driving at night, without dazzling other drivers. (Available as part of the optional Safety Pack on selected Sport Nav+ models at additional cost)

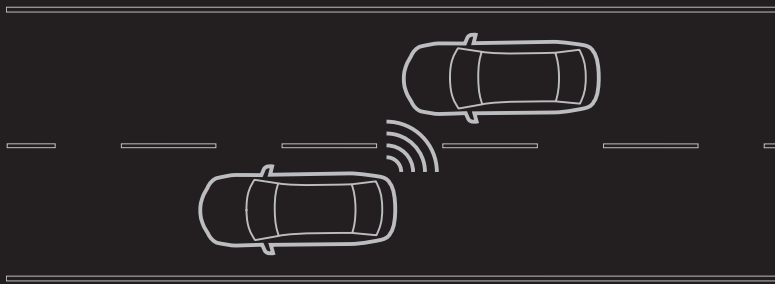

Blind Spot Monitoring

Warns you of a vehicle entering a detection zone situated up to 50 metres behind, by activating a door-mirror mounted warning light on the relevant side of the vehicle. If you then indicate prior to turning in that direction, the warning light flashes and an audible alert sounds. Working at speeds as low as 20mph, this system can prevent drivers from moving into the path of a following vehicle. (Available as part of the optional Safety Pack on selected Sport Nav+ models at additional cost)

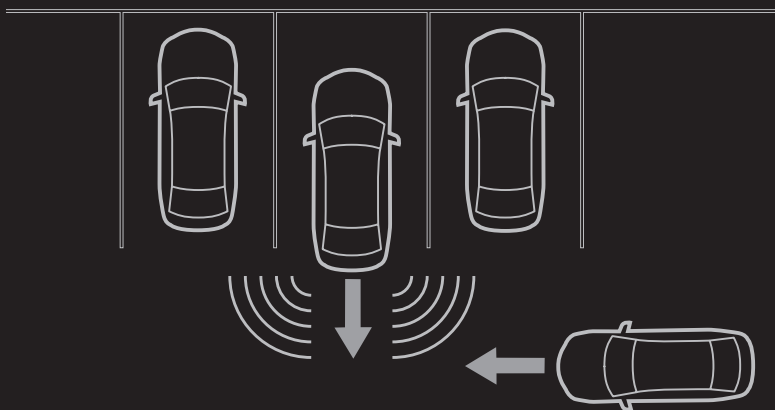

Rear Cross Traffic Alert

Coupled with the Blind Spot Monitoring system, Rear Cross Traffic Alert is designed for when the vehicle is reversing. An alarm alerts you of any vehicles or obstacles approaching from either side of the rear of the car, and silences once the area is clear. (Available as part of the optional Safety Pack on selected Sport Nav+ models at additional cost)





CHOICES

SE NAV+

STANDARD FEATURES:

- 16" Alloy wheels
- Halogen headlights and daytime running lights
- Coming home / leaving home lights
- Heated, auto power-folding door mirrors with integrated indicator lights
- Auto-dimming rear-view mirror
- Front and rear electric windows
- Black cloth seat trim with grey piping
- Leather-wrapped steering wheel and gear knob
- Driver and passenger seat height adjustment
- Cruise control with adjustable speed limiter
- 60:40 split folding rear seats
- Flexible cargo board
- Manual air-conditioning
- Front and rear armrests
- Electronic Parking Brake with auto-hold

- Engine start / stop button
- 7" Colour touch-screen display and Multimedia Commander
- Integrated Bluetooth®
- Internet app integration for internet radio, Facebook® and Twitter®*
- AM / FM / DAB radio with 6 speakers, CD player, USB and iPod® connectivity
- Steering wheel-mounted audio controls
- Driver and passenger front, side and curtain airbags
- Dynamic Stability Control
- Traction Control System
- Hill Hold Assist
- Integrated Navigation System with 3-years free European map updates

OPTIONS:

- Metallic / Mica / Pearlescent paint

*With compatible mobile device. Data usage and costs will vary.

For further information please refer to the Audio and Communications specification table.





Multimedia Commander

Located between the driver and front passenger, the Multimedia Commander allows you to operate the infotainment and connectivity system with minimal effort. It includes a separate volume dial for easy adjustment, ensuring you can concentrate on enjoying the drive.



7" Colour Touch-Screen Display

A large 7" colour touch-screen display coupled with the intuitive Multimedia Commander, provides you with safe and easy fingertip access to all vehicle information, settings, navigation and entertainment.



Electronic Parking Brake with Auto-Hold

The auto-hold function automatically holds the vehicle when stopped, even if you take your foot off the brake pedal. This function can be best used while stopped in traffic or at a traffic light. The brakes are released when you resume driving by simply depressing the clutch or accelerator pedal.



Engine Start/Stop Button

Allows you to conveniently start or stop the engine without having to insert the key.

SE - L NAV+

STANDARD FEATURES (IN ADDITION TO SE NAV+ GRADE):

- LED front fog lights
- Rain-sensing front wipers
- Dusk-sensing headlights
- Climate control air-conditioning
- Heated front seats
- Rear privacy glass
- Rear parking sensors
- Lane Departure Warning System
- Advanced Smart City Brake Support

OPTIONS:

- Metallic / Mica / Pearlescent paint





Rear Parking Sensors

Detects obstructions around the vehicle when manoeuvring or parking, by sounding an audible warning. (Model shown features Matte Silver Rear Under Trim, available as an accessory at additional cost).



Heated Front Seats

Perfect to keep you warm on those chilly mornings. 3-Stage settings provide an extra level of comfort.



Climate Control Air-Conditioning

Helping you to achieve a comfortable driving environment with stylish satin chrome dials.



Rear Privacy Glass

Provides an extra level of sophistication by enhancing the stylish looks and offering extra levels of security.

SPORT NAV+

STANDARD FEATURES (IN ADDITION TO SE-L NAV+ GRADE):

- 18" Silver alloy wheels
- LED headlights
- Front and Rear Signature LED daytime running lights
- Adaptive Front lighting System
- Chrome-accented front bumper and side sill trim
- Half black leatherette, half black cloth trim with grey piping
- Smart keyless entry system
- Reversing camera
- Front and rear parking sensors
- Colour Active Driving Display
- Traffic Sign Recognition
- Heated leather steering wheel
- Premium Bose® sound system with 7 speakers
- i-Loop¹⁾ (regenerative braking system)

OPTIONS:

- Metallic / Mica / Pearlescent paint
- Full Stone leather seat trim with driver power and memory seat²⁾
- Safety Pack (Adaptive LED headlights, Blind Spot Monitoring with Rear Cross Traffic Alert, Rear Smart City Brake Support with Driver Attention Alert)³⁾

¹⁾ Available on 150ps AWD Sport Nav+ Petrol models only

²⁾ Available on Sport Nav+ Petrol models only in combination with Safety Pack

³⁾ Available on Sport Nav+ Petrol models only





BOSE® Sound System

The sensational Bose® surround-sound system was specifically designed for the Mazda CX-3. Featuring seven precisely positioned high-performance speakers that envelop you in a rich, spacious sound experience to keep you entertained on every drive.



Colour Active Driving Display with Traffic Sign Recognition

Projects essential driving information including speed, turn by turn navigation, key traffic signs and emergency warnings via a colour head-up display positioned close to the driver's line of sight.



Signature LED Daytime Running Lights

Be seen with Mazda's Signature LED daytime running lights, designed to ensure you get noticed for all the right reasons, providing the car with a powerful presence on the road.



Reversing Camera

Helps guide you when reversing into a parking space. Parking has never been easier.

TRIMS



PREMIUM BLACK CLOTH TRIM WITH
GREY PIPING



HALF BLACK LEATHERETTE, HALF BLACK
CLOTH TRIM WITH GREY PIPING

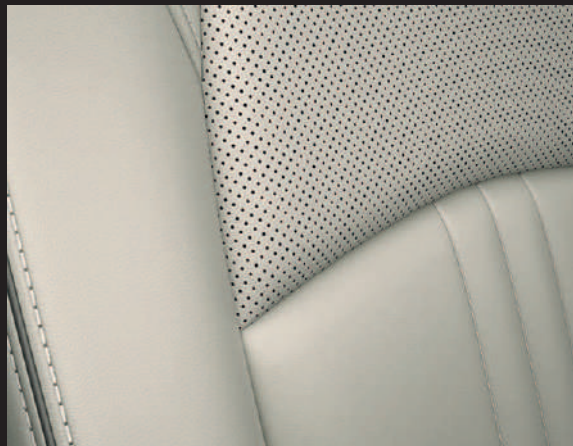

FULL STONE LEATHER TRIM¹⁾

¹⁾ AVAILABLE AT ADDITIONAL COST ON SPORT NAV+
PETROL MODELS (ONLY IN COMBINATION WITH SAFETY
PACK)

WHEELS



16" ALLOY WHEEL (SE NAV+ / SE-L NAV+)



18" SILVER ALLOY WHEEL (SPORT NAV+)

ACCESSORIES



FLOOR MATS



SPACE SAVER SPARE WHEEL KIT



INTERIOR LED LIGHTING PACKAGE



ILLUMINATED SCUFF PLATES



REAR ROOF SPOILER IN BRILLIANT BLACK



ALUMINIUM PEDAL SET



DOOR MIRROR GARNISH IN BRILLIANT BLACK (DECALS NOT INCLUDED)

ACCESSORIES



BOOT LINER



MUD FLAPS



DOOR ENTRY PROTECTION FOIL



REAR VIEW CAMERA



ROOF BOX



DETACHABLE TOW-BAR



ROOF CARRIER

COLOURS



ARCTIC WHITE SOLID



SNOWFLAKE WHITE PEARLESCENT

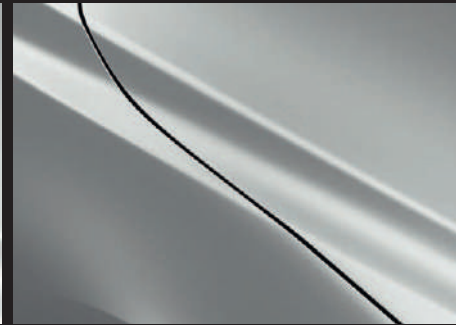

CERAMIC METALLIC



ETERNAL BLUE MICA



DYNAMIC BLUE MICA*

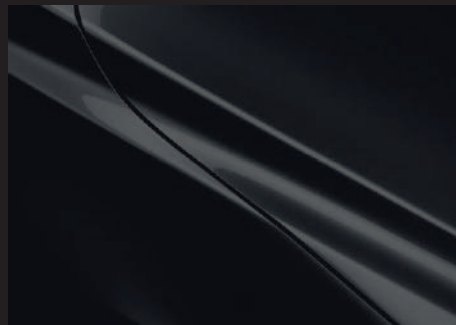

JET BLACK MICA



MACHINE GREY METALLIC

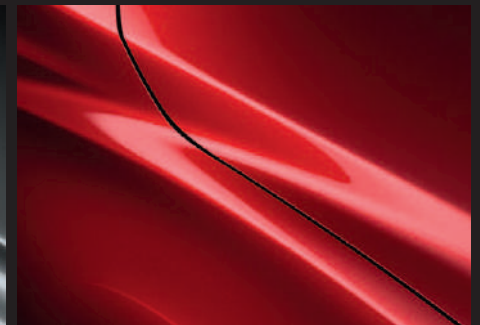

SOUL RED CRYSTAL METALLIC

Model	Exterior Colour							
	Arctic White Solid (A4D)	Snowflake White Pearlescent (25D)	Ceramic Metallic (47A)	Eternal Blue Mica (45B)	Dynamic Blue Mica (44J)*	Jet Black Mica (41W)	Machine Grey metallic (46G)	Soul Red Crystal Metallic (46V)
SE Nav+	●	○	○	○	○	○	○	○
SE-L Nav+	●	○	○	○	○	○	○	○
Sport Nav+	●	○	○	○	○	○	○	○

● = Standard; ○ = Available at additional cost.

* Not available on AWD models



MODEL SHOWN IS MAZDA CX-3 150PS AWD SPORT NAV+ AUTO WITH OPTIONAL SOUL RED CRYSTAL METALLIC PAINT, AVAILABLE AT ADDITIONAL COST

SPECIFICATIONS

Model Availability	2.0 Skyactiv-G Petrol 2WD 121ps Manual	2.0 Skyactiv-G Petrol 2WD 121ps Automatic	2.0 Skyactiv-G Petrol AWD 150ps Manual	2.0 Skyactiv-G Petrol AWD 150ps Automatic	1.8 Skyactiv-D Diesel 2WD 115ps Manual
SE Nav+	●	–	–	–	–
SE-L Nav+	●	●	–	–	–
Sport Nav+	●	●	●	●	●

● = Available. – = Not Available.

Engine Type	2.0 Skyactiv-G Petrol 2WD 121ps Manual	2.0 Skyactiv-G Petrol 2WD 121ps Automatic	2.0 Skyactiv-G Petrol AWD 150ps Manual	2.0 Skyactiv-G Petrol AWD 150ps Automatic	1.8 Skyactiv-D Diesel 2WD 115ps Manual
Displacement (cc)	1,998	1,998	1,998	1,998	1,759
Bore x stroke (mm)	83.5x91.2	83.5x91.2	83.5x91.2	83.5x91.2	79.0x89.7
Valves per cylinder	4	4	4	4	4
Maximum output [ps (kW) / rpm]	121 (89) / 6,000	121 (89) / 6,000	150 (110) / 6,000	150 (110) / 6,000	115 (85) / 4,000
Maximum torque (Nm / rpm)	206/2,800	206/2,800	206/2,800	206/2,800	270/1,600-2,600
Compression ratio	14.0:1	14.0:1	14.0:1	14.0:1	14.8:1
i-Stop	●	●	●	●	●
i-Eloop	–	–	●	●	–

Transmission	2.0 Skyactiv-G Petrol 2WD 121ps Manual	2.0 Skyactiv-G Petrol 2WD 121ps Automatic	2.0 Skyactiv-G Petrol AWD 150ps Manual	2.0 Skyactiv-G Petrol AWD 150ps Automatic	1.8 Skyactiv-D Diesel 2WD 115ps Manual
Type	6-speed manual	6-speed automatic	6-speed manual	6-speed automatic	6-speed manual
Drive system	2WD	2WD	AWD	AWD	2WD
Gear ratios:	1 st 3.363	3.552	3.363	3.352	3.700
	2 nd 1.947	2.022	1.947	2.022	1.947
	3 rd 1.300	1.452	1.300	1.452	1.300
	4 th 1.029	1.000	1.029	1.000	0.916
	5 th 0.837	0.708	0.837	0.708	0.717
	6 th 0.680	0.599	0.680	0.599	0.580
	Reverse 3.385	3.893	3.385	3.893	3.724
Final gear ratio	4.105	4.325	4.388	4.325	3.850

Steering	2.0 Skyactiv-G Petrol 2WD 121ps Manual	2.0 Skyactiv-G Petrol 2WD 121ps Automatic	2.0 Skyactiv-G Petrol AWD 150ps Manual	2.0 Skyactiv-G Petrol AWD 150ps Automatic	1.8 Skyactiv-D Diesel 2WD 115ps Manual
Steering gear	Electronic Power Assist System (EPAS) rack and pinion				
Minimum turning circle (wall to wall) (m)	11.4	11.4	11.4	11.4	11.4

Performance and Economy	2.0 Skyactiv-G Petrol 2WD 121ps Manual	2.0 Skyactiv-G Petrol 2WD 121ps Automatic	2.0 Skyactiv-G Petrol AWD 150ps Manual	2.0 Skyactiv-G Petrol AWD 150ps Automatic	1.8 Skyactiv-D Diesel 2WD 115ps Manual
Acceleration (0-62 mph in sec)	9.0	9.9	8.8	9.7	9.9
Top speed (mph)	119	116	124	121	114
EC emission level	EC Stage 6d-TEMP				
Recommended fuel	Unleaded 95 RON				Diesel
Fuel tank capacity (litres)	48	48	44	44	48
CO ₂ emissions ¹⁾ (g/km)	141	140	160	152	114

WLTP Values:	2.0 Skyactiv-G Petrol 2WD 121ps Manual	2.0 Skyactiv-G Petrol 2WD 121ps Automatic	2.0 Skyactiv-G Petrol AWD 150ps Manual	2.0 Skyactiv-G Petrol AWD 150ps Automatic	1.8 Skyactiv-D Diesel 2WD 115ps Manual	
Fuel consumption ¹⁾ [mpg / (l/100 km)]:	Low	40.4 (7.0)	37.2 (7.6)	30.4 (9.3)	26.9 (10.5)	47.1 (6.0)
	Medium	48.7 (5.8)	45.6 (6.2)	39.8 (7.1)	36.7 (7.7)	64.2 (4.4)
	High	46.3 (6.1)	43.5 (6.5)	42.8 (6.6)	39.8 (7.1)	56.5 (5.0)
	Extra High	36.2 (7.8)	30.4 (9.3)	37.2 (7.6)	34.0 (8.3)	54.3 (5.2)
	Combined	42.8 (6.6)	39.2 (7.2)	38.2 (7.4)	34.9 (8.1)	54.3 (5.2)

● = Standard; – = Not Available.

¹⁾ Figures shown are for comparability purposes; only compare fuel consumption and CO₂ figures with other cars tested to the same technical procedures.

These figures may not reflect real life driving results, which will depend upon a number of factors including the accessories fitted (post-registration), variations in weather, driving styles and vehicle load.

There is a new test used for fuel consumption and CO₂ figures. The CO₂ figures shown however, are based on the outgoing test cycle and will be used to calculate vehicle tax on first registration.

Dimensions and Weights

		2.0 Skyactiv-G Petrol 2WD 121ps Manual	2.0 Skyactiv-G Petrol 2WD 121ps Automatic	2.0 Skyactiv-G Petrol AWD 150ps Manual	2.0 Skyactiv-G Petrol AWD 150ps Automatic	1.8 Skyactiv-D Diesel 2WD 115ps Manual
Overall length / width ¹⁾ / height (mm)		4,275/1,765/1,535				
Wheelbase (mm)		2,570	2,570	2,570	2,570	2,570
Ground clearance (mm) between the axles – unladen		160	160	160	160	160
Track (mm):	Front	1,525	1,525	1,525	1,525	1,525
	Rear	1,520	1,520	1,520	1,520	1,520
Front headroom / leg room / shoulder room (mm)		976/1,058/1,360				
Rear headroom / leg room / shoulder room (mm)		944/888/1,281				
Cargo volume, acc. to VDA (including underfloor storage space) (litres) ²⁾ :	5-seat mode (to belt line)	350 (287)	350 (287)	287	287	287
	2-seat mode	1,260 (1,197)	1,260 (1,197)	1,197	1,197	1,197
Kerb weight (kg) incl. driver (75 kg)	Vehicles equipped with Halogen Headlights	1,305	1,335	N/A	N/A	N/A
	Vehicles equipped with LED Headlights	1,310	1,340	1,385	1,415	1,370
Permitted gross vehicle weight (kg):	Total	1,692	1,727	1,773	1,808	1,755
	Front / rear	878/814	918/809	909/864	942/866	947/808
Permitted axle load, front / rear (kg)		900/867	940/862	931/915	965/918	969/861
Towing limit (kg): ³⁾	Braked	1,200	1,200	1,200	1,200	1,200
Maximum roof load (kg)		50	50	50	50	50

¹⁾ Vehicle width excludes wing mirrors.

²⁾ Figures in brackets are for Sport Nav+ models with Bose® speaker and bass enclosure in rear cargo space.

³⁾ Towing capacity is based on a 12% gradient and tested in accordance with 92/21/EEC as amended by 95/48/EC.

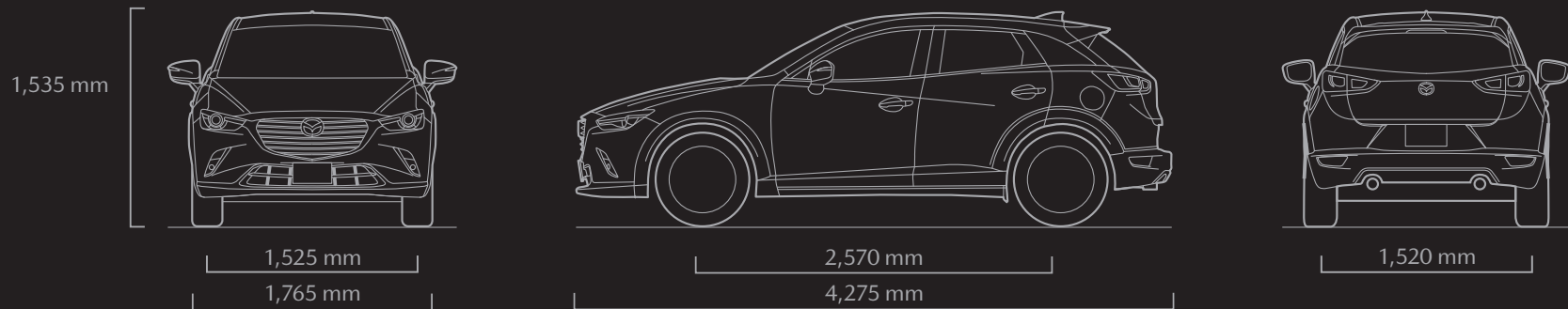

SPECIFICATIONS

Safety and Security	SE Nav+	SE-L Nav+	Sport Nav+
Mazda Advanced Impact Distribution and Absorption System (MAIDAS) engineered 'triple H' body structure to help protect occupants from impact forces	●	●	●
Supplementary Restraint System (SRS) – Central control unit and crash sensors, front seatbelt pre-tensioners, load-limiters and airbag system	●	●	●
Four-wheel Anti-lock Braking System (4W-ABS) with Electronic Brake-force Distribution (EBD)	●	●	●
Advanced Smart City Brake Support (SCBS)	–	●	●
Lane Departure Warning System (LDWS)	–	●	●
Traffic Sign Recognition (TSR)	–	–	●
Adaptive LED Headlights (ALH)	–	–	○
Blind Spot Monitoring (BSM) with Rear Cross Traffic Alert (RCTA)	–	–	○
Driver Attention Alert (DAA)	–	–	○
Rear Smart City Brake Support (RrSCBS)	–	–	○
Dynamic Stability Control (DSC) with Traction Control System (TCS)	●	●	●
Emergency Brake Assist (EBA)	●	●	●
Emergency Stop Signal (ESS)	●	●	●
Dual front airbags	●	●	●
Front side airbags	●	●	●
Front and rear curtain airbags	●	●	●
Front passenger airbag cut-off switch	●	●	●
Hill Hold Assist (HHA)	●	●	●
Tyre Pressure Monitoring System (TPMS)	●	●	●
Seatbelts:			
	Front, 3-point (ELR) x 2 with pre-tensioners, height adjustable	●	●
	Rear, 3-point (ELR) x 3	●	●
	Reminder (driver, front passenger and rear seats), audible warning	●	●
ISOFIX child seat anchorage, attached to outer rear seats	●	●	●
Thatcham category 1 alarm and immobiliser system	●	●	●

● = Standard; ○ = Part of an optional safety pack on Sport Nav+ petrol models. Available at additional cost; – = Not available.

Additional Safety and Security Options

Baby and child seats:	Child seat, 1 st Baby Safe Plus	Please contact your local dealer for further information and availability.
	Child seat, 2 nd ISOFIX Duo Plus	
	Child seat, 3 rd Kid Plus	

Exterior		SE Nav+	SE-L Nav+	Sport Nav+
Tyres and wheels:	215 / 60 R16 with 16" alloy wheels	●	●	–
	215 / 50 R18 with 18" Silver alloy wheels	–	–	●
Emergency Tyre repair kit		●	●	●
Metallic / Mica / Pearlescent paint		○	○	○
Dual exhaust system		●	●	●
Radiator grille:	Silver-accented	●	●	●
Side sill trim:	Black	●	●	–
	Chrome-accented	–	–	●
Front sill trim:	Black	●	●	–
	Chrome-accented	–	–	●
Privacy glass:	Rear and rear side windows	–	●	●
Wipers:	Front, adjustable speed with intermittent wipe	●	–	–
	Front, rain-sensing wipers	–	●	●
	Rear, adjustable speed with intermittent wipe	●	●	●
Headlights:	Halogen, with manual headlight levelling	●	●	–
	LED, with automatic headlight levelling	–	–	●
	Adaptive Front lighting System (AFS)	–	–	●
	Dusk-sensing headlights	–	●	●
	Halogen daytime running lights	●	●	–
	LED daytime running lights	–	–	●
	Coming home / leaving home lights	●	●	●
LED front fog lights		–	●	●
LED Signature rear lights		–	–	●
Parking distance sensors:	Rear	–	●	●
	Front	–	–	●
Reversing Camera:	With static guidance lines shown on the 7" colour display	–	–	●
Shark Fin antenna		●	●	●
Door mirrors:	Electrically-adjustable, heated, auto power-folding door mirrors with integrated indicators	●	●	●

● = Standard; – = Not available; ○ = Option available at additional cost.

Additional Exterior Options

Decorative graphics		Please contact your local dealer for further information and availability.
Roof carrier system:	Roof rack	
	Attachment for skis	
	Thule small attachment for up to four skis or two snowboards	
	Thule large attachment for up to six skis or four snowboards	
	Thule 591 pro bike carrier	
	Thule roof box	
Tow bar:	Detachable	
	Tow bar harness (available in 7-pin and 13-pin)	
	Thule attachment for two bicycles	

SPECIFICATIONS

Interior Features		SE Nav+	SE-L Nav+	Sport Nav+
Seats:	Driver's seat manual slide, recline and height adjustment	●	●	●
	Front passenger's seat manual slide, recline and height adjustment	●	●	●
	Driver's seat, power slide, recline and height adjustment with memory function	–	–	○ ¹⁾
	Heated front seats (3-stage settings)	–	●	●
	Premium black cloth trim with grey piping	●	●	–
	Half black leatherette, half black cloth trim with grey piping	–	–	●
	Full Stone leather trim	–	–	○
Rear seats:	60:40 split fold down rear seats	●	●	●
Front knee pads:	Black	●	●	–
	Black, soft-touch with stitching	–	–	●
Steering wheel:	Leather-wrapped with satin-silver bezel	●	●	●
	Telescopic and tilt adjust	●	●	●
	Paddle shifts for automatic transmission models	–	–	●
	Heated	–	–	●
Gear knob:	Leather-wrapped with piano black surround	●	●	●
	Leather-wrapped with piano black and grey accent stripe	–	–	○ ¹⁾
	Drive mode selection switch ²⁾	–	●	●
Inner door handle surround	Front and rear, satin-silver	●	●	●
Interior Mirror:	Auto-dimming rear-view mirror	●	●	●
Electronic Parking Brake:	With auto-disengage and auto-hold function	●	●	●
Side door trim:	Black, soft-touch	●	●	–
	Black, soft-touch with black leatherette inserts and white stitching	–	–	●
	Grey, soft-touch with LUX SUEDE® and white stitching	–	–	○ ¹⁾
Grab handles:	Front passenger's and two rear with coat hooks	●	●	●
Storage spaces:	Glovebox	●	●	●
	Seatback pocket (rear of front passenger's seat)	●	●	●
	Door pockets (driver, front passenger and rear doors)	●	●	●
	Front and rear centre armrest	●	●	●
	Two cup holders in centre armrest - front and rear	●	●	●
Meter set display:	Trip computer	●	●	●
	Analogue speedometer	●	●	–
	Digital speedometer	–	–	●
	Colour Active Driving Display (head-up display) - shows vehicle speed, warnings, traffic sign information and turn-by-turn navigation	–	–	●
Interior courtesy light, with integrated spotlights		●	●	●
Luggage compartment:	Light	●	●	●
	Tonneau cover	●	●	●
	Flexible cargo board for adjustable floor height or separate secure storage space	●	●	●

● = Standard; ○ = Option at additional cost on Sport Nav+ Petrol models in combination with safety pack only; – = Not available.

¹⁾ Included with Stone leather interior trim. Available at additional cost on Sport Nav+ Petrol models only in combination with safety pack.

²⁾ On petrol automatic models only.

Additional Interior Options

Foot pedals:	Aluminium	Please contact your local dealership for further information and availability
--------------	-----------	---

Comfort and Convenience		SE Nav+	SE-L Nav+	Sport Nav+
Remote central locking with deadlocking		●	●	●
Smart keyless entry system	Allows opening or locking the vehicle without the removal of the key from your bag	–	–	●
Engine start / stop button		●	●	●
Gear shift indicator ¹⁾		●	●	●
Cruise control:	With manual speed adjustment and adjustable speed limiter	●	●	●
Electric windows:	Front and rear, with one-touch auto down / up for driver's window	●	●	●
Air conditioning:	Manual	●	–	–
	Climate control	–	●	●
Air vent louvres:	Piano black surround with chrome inner ring	●	●	●
	Piano black surround with dark red inner ring	–	–	○ ²⁾
Sun visors:	Driver's and front passenger's with covered vanity mirrors and driver's ticket holder	●	●	●
Sunglasses holder	Located in upper console	●	●	●

¹⁾ Manual transmission only.

²⁾ Included with Stone leather interior trim. Available at additional cost on Sport Nav+ Petrol models only in combination with safety pack.

Audio and Communications

Multimedia Commander:	Located between the driver and front passenger, the Multimedia Commander allows easy control of the advanced connectivity and infotainment system, with information displayed on the 7" colour touch-screen display, includes a separate volume control dial	●	●	●
Mazda Multimedia System:	AM / FM / DAB radio, single CD / MP3 audio system with 6 speakers	●	●	–
	AM / FM / DAB radio, single CD / MP3 and Premium Bose® sound system with 7 speakers	–	–	●
	7" Colour touch-screen display	●	●	●
	USB / iPod® connectivity (2 inputs)	●	●	●
	Steering wheel-mounted audio and Bluetooth® controls ¹⁾	●	●	●
Mazda Navigation System:	Auxiliary (AUX) input and 12V power outlet	●	●	●
	European mapping with alternative route calculations, point of interest search and 3-years free map updates	●	●	●
	Premium Connected Services including live traffic and weather information, fuel prices and local search ²⁾	○	○	○
Integrated Bluetooth®:	Allows hands-free calling and easy access to phone contacts via touch-screen or commander as well as voice activation function ¹⁾	●	●	●
	Audio transfer from Bluetooth® devices ¹⁾	●	●	●
	Aha™ app and Stitcher™ app integration for internet radio, Facebook and Twitter functionality ³⁾	●	●	●

● = standard, ○ = option at additional cost on sport nav+ petrol models in combination with safety pack only, – = not available.

¹⁾ Please refer to www.mazdahandsfree.co.uk for the latest information regarding compatibility and functionality of mobile and audio devices.

²⁾ Connected Services are a subscription service. A 60-day free trial is included with your navigation system and commences the first time you connect the car to a Wi-Fi hotspot. After the free trial has finished you must purchase a subscription to continue using Connected Services. Please speak to your dealer or visit www.mazda.co.uk/mzd-connect/navigation for more information.

³⁾ Requires a compatible mobile device. Aha™ / Stitcher™ apps need to be downloaded to mobile device and app registration completed before connection. Data usage and costs will vary, please contact your network provider for more information. Please speak to your dealer or visit www.mazda.co.uk/mzd-connect for more information.

OUR COMMITMENT TO YOU AND YOUR MAZDA

My Mazda App

Designed exclusively for Mazda owners, it provides you with access to important vehicle information, as well as being able to locate your nearest Mazda dealer and track your vehicle service history.

Service and Warranties

Just like the cars themselves, the services we offer are designed to provide you with a first-class ownership experience. Every new vehicle is covered by a 3-year warranty for up to 60,000 miles, including a 3-year paintwork warranty, and a 12-year perforation warranty. We also offer Extended Warranties to extend the cover for your Mazda. Mazda Roadside Assistance offers cover in the event you require breakdown assistance, your vehicle is stolen or is involved in an accident.

The maximum service interval for your Mazda is 12,500 miles or 12 months whichever occurs first, however, the servicing intervals may reduce based on the style of driving and the conditions under which your vehicle is operated.

Free Mazda Accident Aftercare

Mazda Accident Aftercare is designed to assist you following a road traffic accident. Call Mazda First after an accident and they will liaise directly with your insurer to process the claim and ensure that your vehicle is repaired at a Mazda approved bodyshop using only genuine Mazda parts. Additional benefits include providing you with a free courtesy car and maintaining your Mazda warranties.

Our commitment to you and your Mazda

Mazda makes cars that excite, look beautiful, are fun to drive and make you want to drive them again and again. We are passionate about delivering complete motoring confidence and a first-rate ownership experience.

Finance

As well as vehicle warranty and service plans, we offer finance packages to help ensure a rewarding ownership experience. Mazda Financial Services provides a variety of finance products to suit the needs of both private and business customers.

What you can expect from Mazda Financial Services:

- Assistance in renewing your car. We'll help you choose the right finance package to enable you to renew your Mazda as often as you would like.
- Fixed Interest Rates. The interest rate on your loan is fixed for the duration of the agreement
- Flexible terms tailored to your motoring needs. As specialists in Mazda vehicles, we aim to tailor a finance package to both your budget and your motoring and ownership needs.

Please ask your Sales Executive for a tailor-made finance quote for your new car.

Mazda Financial Services finance plans:

Mazda Conditional Sale:

The traditional way of buying your car. Mazda Conditional Sale is a simple way of financing that provides you with certainty due to a fixed interest rate and fixed monthly repayments throughout the agreement. Your initial deposit and repayment period can be structured to help meet your budget and the length of time you expect to keep the car. You can trade in your existing vehicle and put this towards the initial deposit, or if you wish, just put down a cash deposit. At the end of your contract, when all repayments have been made, the car is yours.



Mazda Personal Contract Purchase:

The finance plan that helps you change your Mazda at more regular intervals. Personal Contract Purchase is similar to a Conditional Sale agreement but with additional flexibility since part of the vehicle cost is deferred until the end of the agreement which may give you the benefit of lower monthly repayments. The deferred amount is known as the Guaranteed Future Value or Optional Final Payment.

At the end of your contract, when all repayments have been made, you then have three options:

- **Renew:** Choose another Mazda. Use any excess value above the Optional Final Payment towards a deposit for another Mazda. You can trade in your car at any time or sell it privately having settled your account
- **Retain:** Keep the car. Simply pay the Optional Final Payment, and the car is yours
- **Return your car:** There's nothing more to pay if the car's in good condition and within the agreed mileage

Mazda Contract Hire

Mazda Financial Services Contract Hire offers low running costs with market driven residuals, resulting in extremely competitive costs for businesses and individuals. To find out more about the benefits of Mazda Financial Services Contract Hire, please speak to your Mazda dealer or visit www.mazda.co.uk.

For further information, please visit

<http://www.mazda.co.uk/buying-owning/buying/personal-finance/>

Finance subject to status. Terms and conditions apply. 18s and over. Guarantee may be required. Mazda Financial Services RH1 1SR.

Customer Experience

Start your journey with Mazda using the Configurator on the Mazda website. It lets you customise a digital vehicle, letting you choose from a selection of engines, trims, exterior colours and accessories. Discover the benefits of becoming part of the community that defies convention with My Mazda - the online home for all Mazda owners. The service lets you view and update your personal information using the Mazda Digital Service Record (DSR), which provides security against counterfeit service documents and guarantees a secure, accurate and permanent service history for the life of the vehicle. You can also explore Facebook, Twitter and YouTube for even more Mazda related material. Whatever journey you take with Mazda, we'll make sure it's a unique and gratifying experience.

Skyactiv Technology – helping you stay efficient

We develop exciting cars that are fun to drive, and we are equally committed to the environment for the creation of a sustainable future for all. Our ongoing sustainability programmes are dedicated to the development of clean technologies. Our Skyactiv Technology range includes engines, transmissions, chassis and body designs, which deliver fuel-efficient driving. Our engines deliver the perfect combination of performance and improved driving economy by being lighter and more fuel efficient than many of our competitors.

Looking for more information?

Learn more about our dedication to deliver a unique customer experience online at:



www.mazda.co.uk



facebook.com/mazdauk



twitter.com/mazda_uk



youtube.com/mazdauk

Mazda Motors UK reserves the right to introduce changes in specification and equipment due to its ongoing product development. Colour and trim samples shown in this brochure may vary from the actual colours because of the limitations of the printing process. Models shown may not be to UK specification. It is recommended that you consult your Mazda dealer when referring to these.

Facebook, Twitter, iPod®, Stitcher™, aha™ and Bose® are registered trademarks in the U.S. and other countries. Used with permission

The Bluetooth® word mark and logos are owned by the Bluetooth SIG, Inc. and any use of such marks by Mazda Motor Company is under licence. Other trademarks and trade names are those of their respective owners.

January 2019
Part Number: 810079275

Internet: www.mazda.co.uk
Mazda Helpline: 03457 48 48 48
UK-EN / C4A / NVI-2018

