



DS 3





IT'S ALL ABOUT PERSEVERANCE. YOU CAN HAVE A GREAT  
IDEA BUT IF YOU DON'T FIGHT, IT WON'T GO ANYWHERE.

THIERRY METROZ  
DESIGN DIRECTOR

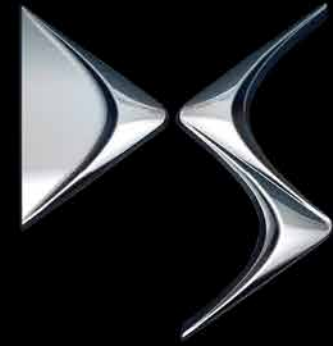

D S L I N E

---

EVERY LINE IS JUSTIFIED BY A FUNCTION.

MARK LLOYD  
STYLING MANAGER



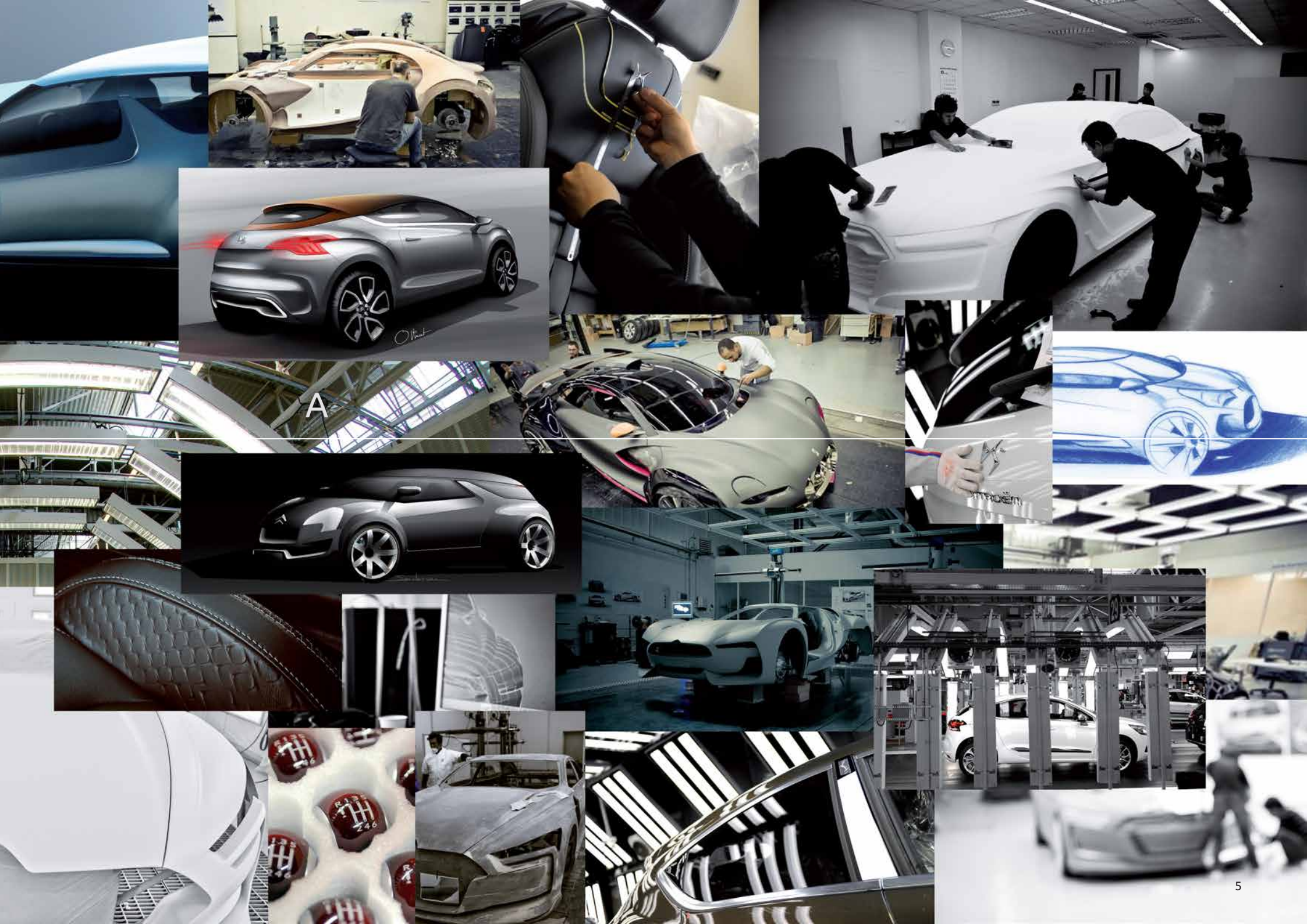



D E S I G N

A

---



THOMAS D'HAUSSY  
RANGE MANAGER

## DESIGN



Sculpted flowing forms reflect DS 3's refined dynamic performance, yet we've maintained a taught compactness in the profile. We were keen to create elements of genuine surprise within its design character as well, clearly epitomised by the dramatic shark fin B pillar – like the design as a whole, that shape is fast becoming a bit of an icon.



CHRISTOPHE POINLANE  
COLOURS AND MATERIALS STYLIST

## COMFORT



You become one with DS 3 when you get in and drive. A big part of that process is about true comfort – it's in the high quality materials that surround you and that you touch, the layout of the controls, the technology... there's an engineered refinement that begins at ground level and is appealing in every sense.

VOL +

RADIO

MUSIC

THIERRY METROZ  
DESIGN DIRECTOR

## INDIVIDUAL



When we created DS 3, we aimed to provide maximum freedom for individual expression – to make it the antithesis of ‘me too’ and generic design. I believe it raises the bar for this kind of personal creative involvement, because the unique character and charisma of the car demand that you make it yours.





MARK LLOYD  
STYLING MANAGER

## STYLE



I think there's an innate desirability about DS 3. There are all kinds of unmistakable style cues that simply belong to this car – that you won't find anywhere else. True style grabs your attention – either at a glance or up close: it's in the magnetism of the whole – its street presence – and in all the details.



**ANTI RETRO.** EACH ELEMENT AND EVERY ANGLE OF DS 3 IS FRESH, ORIGINAL AND INNOVATIVE; ADVANCED AND RADICALLY DIFFERENT FROM OTHER CARS, IT IS A CLEAR EXPRESSION AND CELEBRATION OF CRÉATIVE TECHNOLOGIE.

BUT DS 3 IS ALSO ABOUT YOU, BECAUSE THROUGH ITS HUGE RANGE OF PERSONALISATION OPTIONS, IT ALLOWS YOU TO FINE TUNE A CAR THAT REFLECTS YOUR CHARACTER AND TASTE MORE CLEARLY AND STYLISHLY THAN EVER. THROUGH ELEGANT DESIGN, TACTILE QUALITY AND ADVANCED TECHNOLOGY, DS 3 TAKES FREEDOM OF EXPRESSION TO THE NEXT LEVEL.

› CROWNED 'BEST SUPERMINI'.

DS 3 is the 'Best Supermini' of 2013\* according to a What Car? and JD Power owner satisfaction survey. The survey asked over 16,000 drivers to rate their own cars – the agile DS 3 clearly offers an exceptional owner experience.

**WHATCAR?**  
**JD POWER**  
**SURVEY**  
**2013**  
Best Supermini DS 3

› **CONTENTS:** 12 INTRODUCTION 14 OUTSIDE 16 INDIVIDUALITY 18 DRIVING EXPERIENCE 20 INSIDE 22 TECHNOLOGY & INNOVATION 24 SAFE & EFFICIENT 26 THE RANGE 28 YOUR EXTERIOR 30 YOUR INTERIOR 32 EQUIPMENT SPECIFICATION 34 TECHNICAL SPECIFICATION 36 ACCESSORIES 37 ENVIRONMENTAL COMMITMENT 38 FINANCE, CARE & INSURANCE 39 GLOSSARY & DIMENSIONS

\* DS 3 received the highest numerical score among small cars in the proprietary J.D. Power & Associates 2013 UK Vehicle Ownership Satisfaction Study™. Study based on 16,104 UK consumer responses measuring 116 models and measures ownership satisfaction with two year old vehicles. Proprietary study results are based on experiences and perceptions of consumers surveyed December 2012–February 2013. Your experiences may vary. Visit [jdpower.com](http://jdpower.com).

**INSTANTLY ICONIC.** DS 3 CREATES ITS OWN CLASS AND A NEW TRADITION. EVEN PARKED IT HAS A SUBTLE DYNAMISM AND SENSE OF MOVEMENT, THANKS TO INSPIRING DESIGN SURFACES AND SHAPES.

THE WHOLE PROFILE IS ROBUST AND CHUNKY, YET SMOOTH AND REFINED. A UNIQUE 'SHARK FIN' B PILLAR SWEEPS TOWARDS THE 'FLOATING' ROOFLINE, WHILE TWO ROWS OF SPARKLING LEDS CAN FLANK THE AGGRESSIVE, ROAD HUGGING LOWER GRILLE AND SPOTLIGHTS. THE CHROME UPPER GRILLE ELEGANTLY INCORPORATES THE DOUBLE CHEVRON. TAKE TIME TO LOOK FROM ANY ANGLE AND YOU'LL FIND SURPRISES, ORIGINAL IDEAS AND DELIGHTFUL DETAILS: A DESIGN ICON FOR NOW.





**FORCE OF PERSONALITY.** DS 3 CAN BE AS INDIVIDUAL AS A SIGNATURE. WITH NO FEWER THAN 11 STUNNING BODY COLOUR CHOICES AND 4 CONTRASTING SHADES FOR THE FLOATING ROOF PANEL, THE POTENTIAL FOR PERSONAL EXPRESSION IS VAST.

THE 16 INCH OR 17 INCH ALLOYS CAN BE PURE METAL OR PAINTED, AND AN EXCITING SELECTION OF ROOF GRAPHICS IS READY TO ADD HEAD-TURNING IMPACT. THE BOLD CURVING DASH COMES IN SIX STRIKING FINISHES AND EVEN THE REMOTE PLIP FEATURES A COLOURED DISC – A PERFECT LITTLE SYMBOL OF ULTIMATE PERSONALISATION!







**A MOVING EXPERIENCE.** NOTHING FEELS LIKE DS 3 ON THE MOVE: HERE'S A DRIVING EXPERIENCE LIKE NO OTHER. IT STARTS AS YOU SETTLE INTO THE SCULPTED, BEAUTIFULLY FINISHED DRIVING SEAT THAT'S SET SPORTY AND LOW.

THE COMPACT STEERING WHEEL FEELS JUST RIGHT AND ALL THE VITAL DIALS ARE SET IN A DEEPLY COWLED, CHROME-EDGED TRIPLE POD. TURN THE KEY AND BOTH SPEEDO AND REV COUNTER ZIP ROUND THEIR DIALS AND RETURN TO ZERO. YOU'RE READY TO GO.

There are three petrol engines, from the VTi 82 and VTi 120, to the exciting THP 155, and two super-economical diesels of 90hp or the 120hp, both emitting less than 100g/km CO<sub>2</sub>. All engines balance refined power and the need for cleaner, greener driving.

› LIGHT FANTASTIC

Stunning headlights combine Xenon and LED technologies into a truly hypnotic gaze. Scrolling indicator lights stroke the outer edges in a display of futurism sure to turn heads as you turn corners.

› ROLLING SCULPTURE

Imposing alloy wheels hint at DS 3's poise and finely tuned handling.







**LUXURY REINVENTED.** THE DS 3 INSIDE STORY IS AN ORIGINAL. LOOK AROUND AND YOU'LL SEE INVITING, SERIOUSLY ENVELOPING SEATS, STYLISH AND CRYSTAL CLEAR INSTRUMENTS AND PERFECTLY HONED DETAILS, ALL IN HIGH QUALITY, TACTILE MATERIALS.

BRUSHED METAL, POLISHED CHROME AND LEATHER MAKE IT A SENSORY TREAT. THE BODY HUGGING DRIVER'S SEAT IS FULLY ADJUSTABLE AND AN OPTIONAL RETRACTABLE FRONT ARMREST ALSO FUNCTIONS AS A USEFUL STORAGE SPACE. EVERYWHERE THERE ARE BIG CAR REFINEMENTS AND INNOVATIVE LUXURY DETAILS, REDEFINED FOR DS 3.

› PEDAL POWER

On DSire and DSport models the tough, stylish, aluminium pedals have grippy rubber inserts for perfect footwork.



› SENSUAL WORLD

Lustrous finishes, supple leather and fresh shapes are a treat for your senses.

› ELEGANT COMFORT

The added comfort of a front armrest on selected versions, features a handy storage compartment.



# INNOVATION EVERYWHERE.

## ADVANCED TECHNOLOGY AND INTELLIGENT DETAILS CAN BE SEEN EVERYWHERE ON DS 3. LIKE EVERY DS, IT HAS INNOVATION IN ITS DNA.

THE RDS RADIO/MP3 CD PLAYER AND THE AUXILIARY SOCKET CAN BE DRAMATICALLY TRANSFORMED BY THE POWERFUL HI-FI SYSTEM. YOU CAN ALSO SELECT EMYWAY SAT NAV WITH EUROPEAN MAPPING, WHICH PROVIDES AERIAL VIEW DISPLAYS ON A 7 INCH 16/9 SCREEN. A HEAD TURNING SIGNATURE OF DS 3 IS ITS STYLISH, SAFE LED DAYTIME RUNNING LIGHTS THAT SPARKLE EITHER SIDE OF THE LOWER GRILLE.

### > EFFORTLESS COOL

Automatic air conditioning – standard on DSire and DSport models – maintains an ideal interior temperature and is easy to adjust using the two clever multi-function dials.

### > EMYWAY – YOUR WAY

Choose eMyWay sat nav with 7 inch colour screen and get to any European destination minus hassle.

### > FRONT ROW SEATS

Placing you at the heart of every song, DS 3's optional Hi-Fi system adds a third central speaker in the dashboard and a rear integrated subwoofer within the boot.



### > LOOKS GOOD, IS GOOD

The bold curves of the dashboard, with its chrome trimmed dials and fingertip controls house all your chosen technology: form and function in perfect harmony! Even the key fob is a little personalised work of art.

### > MAKE THE CONNECTION

Connecting Box, standard on DStyle, DSire and DSport, includes a USB dock nestling in the centre console, meaning that you can charge your phone on the move or play music from your USB stick.



# IT'S YOUR WORLD. DS 3 IS FOR INDIVIDUALS, AND UNDERSTANDS THAT PROTECTING YOUR LOVED ONES WHILE MINIMISING ENVIRONMENTAL IMPACT ARE IMPORTANT PERSONAL CHOICES.

THAT'S WHY ALL DS 3 MODELS HAVE STANDARD ESC, ABS WITH ELECTRONIC BRAKEFORCE DISTRIBUTION (EBD) AND EMERGENCY BRAKING ASSISTANCE (EBA), WHILE THE INTERIOR FEATURES NO FEWER THAN SIX AIRBAGS. THE EURO NCAP TEST HAS RECOGNISED DS 3'S ADVANCES, BY AWARDING IT THE MAXIMUM 5 STAR SAFETY RATING.

And if that doesn't stop you in your tracks, Active City Brake technology will. Sensors continually monitor the distance to the vehicle in front – if that distance reduces too quickly for you to come to a safe stop whilst driving below 20mph, Active City Brake technology will apply the brakes for you.

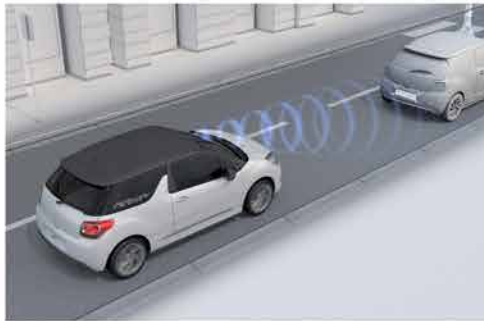

## > SAFELY ANCHORED

Child safety is as important to us as it is to you. Isofix anchorage points on the outer rear seats ensure that children are safe and secure.

## > CHANGE FOR GOOD

DS 3 helps you drive with the environment in mind thanks to its Gear Efficiency Indicator (GEI) on manual models, which lets you know exactly which gear is most efficient and reduces the ecological impact and fuel consumption.



**TAKE FOUR INDIVIDUALS.**  
DS 3 IS A RANGE OF FOUR  
MODELS. THEY ARE POINTS  
OF DEPARTURE FOR YOUR  
INDIVIDUALITY. HERE IS  
WHERE YOUR OWN DS 3  
COMES ALIVE.

WHETHER YOU GO FOR DSIGN OR DSTYLE, YOU'LL BE  
STARTING WITH A BEAUTIFULLY STYLED AND BRILLIANTLY  
ENGINEERED DS: WHERE BETTER TO BEGIN?



> DS 3 DSIGN



> DS 3 DSTYLE

# DSIGN

## A DRAMATIC ENTRANCE

FASCINATING FROM EVERY ANGLE, TEEMING WITH GREAT DETAILS AND READY TO RAISE A GRIN ON ANY DRIVE, DS 3 DSIGN HAS A VERY NON-STANDARD STANDARD SPECIFICATION THAT BRINGS YOU THE FEATURES AND TECHNOLOGY THAT MATTER.

› DS 3 **DSIGN** SPECIFICATION INCLUDES:

- ABS with Electronic Brakeforce Distribution and Emergency Braking Assistance
- Electronic Stability Control
- Driver's, front passenger's, front lateral and curtain airbags
- Front seat belt pre-tensioners with force-limiters
- Cruise control with speed limiter
- Remote central locking with deadlocks
- **LED Signature** – LED Daytime Running Lights (DRLs), front fog lights and chrome grille surrounds and chrome insert on rear number plate moulding
- 16 inch 'Nuclear' wheel covers
- Roof colour door mirrors
- Chrome door handles
- Chrome door sill protector
- Chrome side rubbing strips
- Electrically adjustable door mirrors
- Front electric windows with 'one-touch' operation on driver's side
- Rear 1/3-2/3 split/folding seats
- 12 volt socket in cabin
- Multi-function on-board trip computer
- Leather steering wheel
- Gear Efficiency Indicator (manual models only)
- Variable power assisted steering
- Sport suspension
- RDS stereo radio/MP3 CD player with six speakers and steering mounted controls
- AUX socket

# DSTYLE

## DYNAMIC IN DETAIL

FROM NOSE TO TAIL DS 3 DSTYLE FEATURES EXCLUSIVE DETAILS AND STYLING FLOURISHES, FROM ITS LEDS TO INTERIOR MOOD LIGHTING AND DARK TINTED WINDOWS. EVERY ELEMENT HAS BEEN METICULOUSLY CHOSEN TO HEIGHTEN DS 3'S SENSORY IMPACT. AND IT'S EVEN AVAILABLE AS A 95G/KM CO<sub>2</sub> MODEL.

› DS 3 **DSTYLE** SPECIFICATION IN ADDITION TO DSIGN INCLUDES:

- 16 inch black 'Ashera' alloy wheels
- Dark tinted rear windows
- Air conditioning
- Interior mood lighting
- Scented air freshener
- **Connecting Box** – Bluetooth® handsfree with USB socket

	DSign	DStyle
<b>PETROL ENGINE AVAILABILITY</b>		
VTi 82 manual	•	
VTi 120 manual		•
VTi 120 automatic		•
<b>DIESEL ENGINE AVAILABILITY</b>		
e-HDi 90 Airdream manual		•

**MORE POWER TO YOU.**

DS 3 DSIRE AND DSPORT  
MODELS START WITH MORE.  
MORE EQUIPMENT, MORE  
LUXURY, MORE INDIVIDUALITY...  
SAY NO MORE.



> DS 3 DSIRE



> DS 3 DSPORT

# DSIRE

## HEART AND SOUL

BIGGER ALLOYS, A REAR SPOILER, DOUBLE CHROME EXHAUST AND LUXURY TO YOUR HEART'S CONTENT. DS 3 DSIRE SETS YOUR PULSE RACING SO NATURALLY GETS OUR MOST POWERFUL PETROL AND DIESEL ENGINES.

› DS 3 **DSIRE** SPECIFICATION IN ADDITION TO DSTYLE INCLUDES::

- 17 inch black 'Bellone' alloy wheels
- Rear spoiler with integrated third brake light
- Double chrome exhaust pipe
- Aluminium drilled pedals
- Sport seats
- Automatic lights and windscreen wipers
- Automatic air conditioning
- Rear parking sensors
- Front armrest
- Height-adjustable front passenger's seat

# DSPORT

## THE ULTIMATE

THE DEFINITIVE DS 3 MIXES LAVISH DETAILS, EYE CATCHING STYLE, INGENIOUS TECHNOLOGY AND FINE MATERIALS TO CREATE THE ULTIMATE FORMULA. ALL THAT'S LEFT TO DO IS ADD YOU.

› DS 3 **DSPORT** SPECIFICATION IN ADDITION TO DSTYLE INCLUDES:

- New Xenon Full LED Signature
- **Auto Signature** – Active City Brake, automatic air conditioning, automatic lights and windscreen wipers, electrochrome rear view mirror, electrically heated folding door mirrors
- High quality leather steering wheel with chrome inserts
- Leather gear knob
- Leather door panels
- Front and rear carpet mats
- Citroën eTouch Emergency & Assistance System

	DSire	DSport
<b>PETROL ENGINE AVAILABILITY</b>		
THP 155 6-speed manual	•	•
<b>DIESEL ENGINE AVAILABILITY</b>		
BlueHDi 120 6-speed manual	•	•



**THE PERSONAL JOURNEY: OUTSIDE.**  
THE POSSIBILITIES ARE ENDLESS...  
DS 3 PRESENTS A MULTITUDE OF  
WAYS TO MAKE IT A VERY PERSONAL  
CHOICE. ONCE YOU'VE CHOSEN  
FROM 11 STUNNING BODY COLOURS,  
IT'S TIME TO CONSIDER A SHADE  
FOR THAT 'FLOATING' ROOF. TAKE  
YOUR TIME; THERE ARE 35 POTENTIAL  
COMBINATIONS...

> DOOR MIRROR COLOURS



> KEY COLOURS



ROOF COLOURS



BODY COLOURS



16 INCH 'NUCLEAR'  
WHEEL COVERS  
Tyres: 195/55 R16



16 INCH BLACK  
'ASHERA' ALLOY  
WHEELS  
Tyres: 195/55 R16



17 INCH BLACK  
'BELLONE' ALLOY  
WHEELS  
Tyres: 205/45 R17



(M) Metallic (P) Pearlescent

Please note: Colours and pictures shown are for illustration purposes only. Please consult your Dealer for definitive colour and trim/upholstery details. Please check the DS 3 'Touch' brochure for availability, cost and the full range of wheels.

# THE PERSONAL JOURNEY: INSIDE. INDULGE YOUR SENSES INSIDE DS 3 AND CREATE AN INTERIOR THAT REFLECTS YOU. EVERY DETAIL CAN BE FINE TUNED TO YOUR TASTES.

## > TRIMS



Mistral 'Rayados' cloth

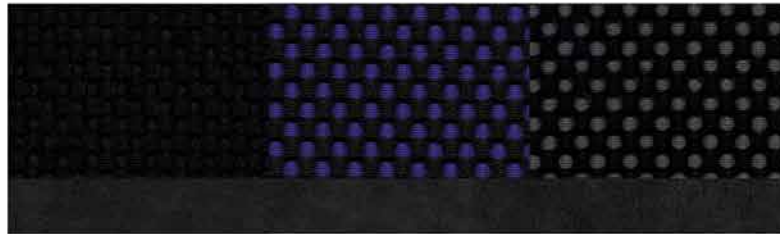

'Akinen' cloth in Mistral, Infinite Blue or 'Brun Chic' with Mistral Alcantara®



Mistral 'Sturm' cloth



Black leather pack, Granite Blue leather pack or Grey/black leather pack

## > GEAR LEVERS



Black



Moondust



Black leather



White



Infinite Blue

## > DASHBOARDS



## FREEDOM TO EXPRESS YOURSELF.

ACCESSORISE YOUR DS 3 WITH A CHOICE OF 6 NEW ROOF DESIGNS, IN VARIOUS COLOURS TO PERFECTLY REFLECT YOUR PERSONALITY AND STYLE.

THESE UNIQUE ROOF DESIGNS ARE AVAILABLE AS ACCESSORIES. FOR MORE WAYS TO PERSONALISE YOUR DS 3 VISIT [WWW.ACCESSORIES.CITROEN.CO.UK](http://WWW.ACCESSORIES.CITROEN.CO.UK)



# EQUIPMENT SPECIFICATION

	DSign	DStyle	DSire	DSport
<b>SAFETY &amp; SECURITY</b>				
ABS with Electronic Brakeforce Distribution and Emergency Braking Assistance	●	●	●	●
Electronic Stability Control (ESC)	●	●	●	●
Driver, front passenger, front lateral and curtain airbags	●	●	●	●
Front seat belt pre-tensioners with force-limiters	●	●	●	●
Five three-point inertia reel seat belts	●	●	●	●
Unfastened seat belt warning for driver's seat	●	●	●	●
Automatic activation of hazard warning lights	●	●	●	●
Remote central locking with deadlocks	●	●	●	●
Automatic door and boot locking	●	●	●	●
Rear ISOFIX anchorage points	●	●	●	●
Cruise control with speed limiter	●	●	●	●
Active City Brake		○ <sup>1</sup>		●
Anti-theft alarm				●
Citroën eTouch Emergency & Assistance System				●
<b>LIGHTING &amp; VISIBILITY</b>				
Halogen headlights	●	●	●	●
New Xenon Full LED Signature	○	○		●
Electrically adjustable door mirrors	●	●	●	●
Electrically heated folding door mirrors	○ <sup>1</sup>	○ <sup>1</sup>	●	●
Electrochrome rear view mirror	○ <sup>1</sup>	○ <sup>1</sup>	●	●
LED Signature – LED Daytime Running Lights (DRLs), front fog lights chrome surrounds, front grille chrome surround and chrome insert on rear number plate moulding	●	●	●	●
Automatic lights and windscreen wipers	○ <sup>1</sup>	○ <sup>1</sup>	●	●
3D LED Rear lights	●	●	●	●
Boot light	●	●	●	●
Front courtesy reading lights	●	●	●	●
Front fog lights	●	●	●	●
Interior mood lighting		●	●	●
<b>DRIVER INFORMATION</b>				
Tyre pressure monitor	●	●	●	●
Multi-function on-board trip computer (current fuel consumption, average fuel consumption, distance covered, average speed and range on remaining fuel)	●	●	●	●
Puncture repair kit	●	●		●
Space saver steel spare wheel			●	●
Rev counter	●	●	●	●
Gear Efficiency Indicator	●	○ <sup>2</sup>	●	●
Exterior temperature display	●	●	●	●
'Black panel' on/off instrument lighting	●	●	●	●

Please check the DS 3 'Touch' brochure for further equipment availability and cost.

● Standard equipment

○ Optional factory fitted equipment

1 Available only as part of optional City or Auto Signatures.

2 Excludes automatic version.

3 Available only when optional half Alcantara® trims are ordered.

4 Available only when optional leather packs are ordered.

5 Mobile phone compatibility can vary by phone manufacturer. Please consult your Dealer for further compatibility information.

	DSign	DStyle	DSire	DSport
<b>STYLE</b>				
<b>EXTERIOR</b>				
Matching body/roof colour	○	○	○	○
Contrasting body/roof colour	●	○	●	●
Roof colour door mirrors with chrome base	○	○	●	●
Chrome side rubbing strips	●	●	●	●
Chrome front fog light surrounds	●	●	●	●
Chrome front grille surround	●	●	●	●
Chrome insert on rear number plate moulding	●	●	●	●
Coloured key	●	●	●	●
Chrome door handles	●	●	●	●
Rear spoiler with an integrated third brake light			●	●
Dark tinted rear windows		●	●	●
Double chrome exhaust pipe			●	●
<b>INTERIOR</b>				
'Soft-touch' effect upper dashboard	●	●	●	●
Black centre console	●			
Gloss black centre console		●	●	●
Black interior door handle surrounds	●			
Gloss black interior door handle surrounds		●	●	●
Chrome gear surround		●	●	●
Leather handbrake with chrome insert		●	●	●
Leather effect gear knob and gear lever		●	●	●
Leather steering wheel with aluminium effect inserts	●			
Leather steering wheel with chrome inserts		●	●	
High quality leather steering wheel with chrome inserts				●
Front and rear carpet mats				●
Aluminium drilled pedals		○ <sup>3/4</sup>	●	●
Chrome door sill protector	●	●	●	●
<b>STORAGE</b>				
Front door pockets with bottle holder	●	●	●	●
Front seat back pockets				●
Lashing eye in the boot	●	●	●	●

	DSign	DStyle	DSire	DSport
<b>COMFORT &amp; CONVENIENCE</b>				
Variable power assisted steering	•	•	•	•
Sport suspension	•	•	•	•
Height and reach adjustable steering wheel	•	•	•	•
Scented air freshener	•	•	•	•
12 volt socket in cabin	•	•	•	•
Air recirculation and pollen filter	•	•	•	•
Driver's and passenger's sunvisor with courtesy mirror	•	•	•	•
Front electric windows with 'one-touch' operation driver's side	•	•	•	•
Air conditioning	•	•	•	•
Automatic air conditioning	o <sup>1</sup>	o <sup>1</sup>	•	•
Rear parking sensors	o <sup>1</sup>	•	•	•
Front armrest	o <sup>1</sup>	•	•	•

	DSign	DStyle	DSire	DSport
<b>SEATING</b>				
Height-adjustable driver's seat	•	•	•	•
Height-adjustable front passenger's seat	o <sup>3/4</sup>	o <sup>3/4</sup>	•	•
Three rear head restraints	•	•	•	•
Rear 1/3-2/3 split/folding seats	•	•	•	•
<b>IN-CAR ENTERTAINMENT</b>				
RDS radio/MP3 CD player with six speakers, AUX socket and steering mounted controls	•	•	•	•
<b>Connecting Box</b> – Bluetooth® handsfree with USB socket		• <sup>5</sup>	• <sup>5</sup>	• <sup>5</sup>



# TECHNICAL SPECIFICATION



**78.5mpg**  
on BlueHDi 120  
6-speed manual



**94g/km CO<sub>2</sub>**  
on BlueHDi 120  
6-speed manual

	PETROL MODELS				DIESEL MODELS	
	VTi 82 manual	VTi 120 manual	VTi 120 automatic	THP 155 6-speed manual	e-HDi 90 Airdream manual	BlueHDi 120 6 speed manual
<b>ENGINE</b>						
Capacity (cc)	1199	1598	1598	1598	1560	1560
Cylinders	3	4 in line	4 in line	4 in line	4 in line	4
Max power CEE (kW/rpm)	60/5750	88/6000	88/6000	115/6000	68/4000	88/3500
Max torque CEE (Nm/rpm)	118/2750	160/4200	160/4200	240/1400	230/1750	285/1750
Fuel system	Multi-point electronic fuel injection	Multi-point electronic fuel injection	Multi-point electronic fuel injection	Multi-point electronic turbocharged fuel injection	High pressure direct diesel injection	High pressure direct diesel injection
Euro status	Euro 5	Euro 5	Euro 5	Euro 5	Euro 5	Euro 6
<b>TRANSMISSION</b>						
Four speed automatic			•			
Five speed manual	•	•			•	
Six speed manual				•		•
Clutch type	Dry single plate	Dry single plate	N/A	Dry single plate	Dry single plate	Dry single plate
<b>PERFORMANCE</b> <small>(All figures driver alone)</small>						
Max speed (mph)	108	118	118	130	113	118
0-62mph (secs)	14.2	9.9	12.2	7.3	12.5	9.3
Standing 1000m (secs)	35.4	31.4	32.4	28.2	34.2	31.4
<b>ECONOMY Litres/100km (mpg)</b> <small>(Official Government test fuel consumption figures)</small>						
Urban cycle	5.5 (51.4) – 5.6 (50.4)▲	7.3 (38.7)	9.3 (30.4)	7.9 (35.8)	4.3 (65.7)	4.4 (64.2)
Extra urban	3.9 (72.4) – 4.1 (68.9)▲	4.5 (62.8)	4.9 (57.6)	4.5 (62.8)	3.3 (85.6)	3.2 (88.3)
Combined	4.5 (62.8) – 4.6 (61.4)▲	5.6 (50.4)	6.5 (43.5)	5.8 (48.7)	3.6 (78.5)	3.6 (78.5)
<b>CO<sub>2</sub> EMISSIONS (g/km)</b>						
	104 – 107▲	129	150	135	95	94
<small>Please note: the maximum plated weights must not be exceeded</small> <b>WEIGHTS (kg)</b>						
Kerb Weight	975	1075	1089	1090	1085	1200
Mass in service	1120	1189	1222	1223	1160	1275
Max laden weight	1496	1554	1587	1590	1625	1665
Max towing weight braked/unbraked	1100/520	1150/570	1150/570	1150/570	1150/570	1150/570
Max roof rack load	70	70	70	70	70	70
<b>BRAKES</b>						
	ESC and ABS with EBD and EBA standard on all models					
Front discs, rear drums	•					•
Front discs, rear discs		•	•	•	•	
<b>STEERING</b>						
	Variable power assisted steering					
Number of turns lock to lock	3.1	3.1	3.1	3.1	3.1	3.1
Turning circle between kerbs (m)	10.2	10.2	10.4	10.4	10.4	10.4
<b>SUSPENSION</b>						
	Pseudo MacPherson strut front with deformable beam rear					
<b>FUEL TANK CAPACITY Litres (gallons)</b>						
	48 (10.6)					
<b>EXTERIOR DIMENSIONS (mm)</b>						
	Length/Width/Height/Wheelbase					
	3948/1715/1483/2464					
<b>BOOT VOLUMES &amp; DIMENSIONS</b>						
	Seats up – below parcel shelf max (litres VDA)					
	285					

▲ When optional 17" 'Bellone' alloy wheels are ordered.

MPG figures are achieved under official EU test conditions, intended as a guide for comparative purposes only, and may not reflect actual on-the-road driving conditions.

# EFFICIENCY MINUS COMPROMISE. CITROËN HAS CREATED FUELEFFICIENT VEHICLES WITHOUT SACRIFICING DRIVER ENJOYMENT FOR SOME TIME. THE LATEST ADVANCES TAKE THIS FINE BALANCE FURTHER STILL...

WITH THE PROVEN CREDENTIALS AND ENVIRONMENTAL PERFORMANCE OF CITROËN HDi DIRECT INJECTION ENGINES AS INSPIRATION, e-HDi ADDS NEW TECHNOLOGY, SUCH AS A SMOOTH, SIMPLE STOP & START SYSTEM AND ETG. STOP & START PUTS THE ENGINE INTO IDLE MODE AS YOU DECELERATE AND STOPS ALTOGETHER AS YOU COME TO A HALT. THE MOMENT YOU TAKE YOUR FOOT OFF THE BRAKE, IT RESTARTS SILENTLY AND WITHOUT VIBRATION. THE RESULTS ARE A DRAMATIC REDUCTION IN BOTH FUEL CONSUMPTION AND CO<sub>2</sub> EMISSIONS, COMBINED WITH RESPONSIVE PERFORMANCE WHEREVER YOU GO.

We've also been equipping more of our vehicles with more environmentally friendly breakthroughs, such as our Efficient Tronic Gearbox (ETG), which boasts impressively greener credentials, with less pollution and up to 5% more economy than a conventional manual gearbox system. In addition, Citroën has expanded the use of the exceptionally efficient, self-regenerating Diesel Particulate Filter System in our models. Cleaner, greener driving without taking away from the drive – that's what you can continue to expect from Citroën.



## › PURE TECHNOLOGY

Demonstrating Citroën's commitment to Créative Technologie, PureTech engines provide increased power with lower fuel consumption and emissions by adopting a smaller and lighter three cylinder configuration constructed of pressure-cast aluminium. In conjunction with low friction component coatings, improved air and fuel flow and optimised combustion, this allows engines to offer more power, better fuel economy and significantly lower CO<sub>2</sub> emissions.

## › AIRDREAM – A BENCHMARK

Citroën's environmental commitment and advanced efficiency are perfectly illustrated by Airdream. It's a benchmarking scheme that has three demanding criteria which a vehicle must achieve before it can wear the name. Firstly it must emit no more than 140g/km CO<sub>2</sub>. Secondly it must be produced at a plant that meets the rigorous ISO 14001 certification and also it must be 95% recoverable. Only e-HDi, electric or Hybrid4 engined Citroëns currently qualify. It's no surprise that Citroën is one of the leaders in Europe for low CO<sub>2</sub> emissions.

## › ELECTRIFYING. HOWEVER YOU LOOK AT IT

Forget what you know about electric cars. Citroën Survolt concept combines undiluted glamour with advanced sporting dynamics, then adds a 100% electric drivetrain. Outside, LED lights, voluptuous curves, two-tone charcoal and fuchsia paintwork, and a race-inspired rear spoiler meet your gaze. Inside, a stunning blend of curved chrome, swooping glass, high technology and organic forms welcomes you to an entirely new place. But this is no simple styling exercise. At heart, Survolt is even more radical, because although it is designed to thrill, it is powered purely by silent, efficient, clean electricity.



# DRIVE YOUR WAY. GET BEHIND THE WHEEL OF YOUR NEW DS 3, WITH CITROËN'S RANGE OF FINANCE AND INSURANCE PRODUCTS.

## CITROËN FINANCIAL SERVICES

**PURCHASE PLAN**  
Own your vehicle with this flexible package designed to fit your budget.

**ELECT 3**  
A new Citroën car every two or three years with monthly payments structured to suit your budget.

**ELECT 4**  
Enjoy the convenience of a new car without the stress and hassle of ownership.

TO FIND OUT MORE ABOUT CITROËN PRODUCTS AND SERVICES, GO TO [WWW.CITROEN.CO.UK](http://WWW.CITROEN.CO.UK) OR CONTACT YOUR CITROËN DEALER.

FOR BUSINESS USERS

## CITROËN CONTRACT MOTORING

**HIRE PURCHASE**  
A tried and tested finance package that allows you to own your vehicle.

**BUSINESS LEASE**  
An alternative to vehicle ownership that allows you to control your business cash flow and gain tax efficiencies.

**LEASE PURCHASE**  
Own a vehicle with a finance solution that offers ultimate flexibility to complement your business cash flow.

**CONTRACT HIRE**  
A non-ownership finance solution that keeps costs fixed and risks low.

FOR MORE INFORMATION ON CITROËN FLEET AND BUSINESS SALES, PLEASE CALL CITROËN FLEET CONNECT ON 08457 940 940 OR LOOK US UP AT [WWW.CITROEN.CO.UK/FLEET](http://WWW.CITROEN.CO.UK/FLEET)

## CITROËN INSURANCE

**INSTANT COVER**  
To help you drive away your new car without delay, we offer Instant Cover insurance, providing you with 7 days comprehensive car insurance, for free!

**MOTOR INSURANCE**  
Citroën Insurance has been designed specifically for our vehicles. You don't just get repairs you get Citroën expertise, service, quality and parts. So, when the time comes to renew your insurance cover, call Citroën Insurance on 0870 024 2725.

Lines open 8am - 8pm weekdays, 9am - 5pm Saturdays. Max call charge from a BT landline is 8p per minute. Calls from other networks may vary. Alternatively, visit [www.citroen.co.uk](http://www.citroen.co.uk) for more information or to apply online.

Citroën Insurance is underwritten by U K Insurance Ltd which is authorised and regulated by the Financial Conduct Authority. Citroën Insurance is a trading style of Banque PSA Finance UK of Quadrant House, Princess Way, Redhill, Surrey, RH1 1QA.

# CARE FOR YOUR NEW DS 3 AND IT WILL LOOK AFTER YOU – LIKE EVERY DS IT'S PART OF LEGENDARY ENGINEERING HERITAGE WITH RELIABILITY BUILT IN.

WITH THE ADDED REASSURANCE OF A WARRANTY, ROUTINE SERVICING AND MAINTENANCE, AS WELL AS 24-HOUR ROADSIDE ASSISTANCE, YOU ARE PROTECTED.

## CITROËN WARRANTY

Every new Citroën car has the benefit of a 3 year\* warranty package, plus a 12 year anti-perforation\*\* warranty and a 3 year paint warranty.

\* 2 years' unlimited warranty. No-fee customer option of 1 year's Dealer provided warranty, only on cars sourced from Citroën UK Limited. Note: Dealer provided warranty is limited to 60,000 miles for cars.

\*\* Against all internal to external perforation to bodywork or underbody.

## CITROËN ASSISTANCE

In response to a free telephone call in the UK, Citroën Assistance brings rapid expert roadside assistance to you in an emergency. It comes free of charge for a full year and operates 24 hours a day in all parts of the UK and Europe. Services include nationwide recovery for both car and passengers, a home call service, replacement vehicle, hotel accommodation and vehicle storage if required. Please note, Citroën Assistance only applies to incidents covered by the new vehicle warranty, and excludes non-vehicle faults, such as running out of fuel, mis-fuelling, loss of keys, lock-ins, road traffic accidents and punctures/wheel changes.

Full details are available on request from Citroën UK via [cuk\\_contactcentre@citroen.com](mailto:cuk_contactcentre@citroen.com)

## CITROËN MAINTENANCE

From roadside assistance to replacing wear and tear parts or regular servicing, with Citroën Maintenance you have total peace of mind. For a one-off fee or low monthly payment, our experienced engineers will take care of your Citroën, whatever happens. To find out more, contact your Citroën Dealer or Citroën Authorised Repairer.

## CITROËN SERVICING

Available up to 1 year from your vehicle's registration date, but before its first chargeable service, a Citroën Servicing Package enables you to pay in advance for your vehicle's servicing needs for 3 years/35,000 miles.

For further information, please contact your Citroën Dealer.

# GLOSSARY

## › BlueHDi DIESEL ENGINE

The BlueHDi 120 engine is Euro 6 compliant and offers a more powerful Diesel option versus the e-HDi 90 engine with less CO<sub>2</sub> emissions.

## › e-HDi DIESEL ENGINE

The e-HDi 90 Airdream manual engine is capable of up to 78.5mpg and CO<sub>2</sub> emissions of as little as 95g/km. It has a reversible starter-alternator that works in tandem with an e-boost to provide a seamless Stop & Start function. Going further than other similar systems, the e-HDi's Stop & Start puts the engine into idle mode while decelerating before coming to a complete standstill. This reduces consumption by 15% in urban driving.

## › ANTI-LOCK BRAKING SYSTEM (ABS)

Computer-controlled braking assistance designed to prevent the wheels from locking under extreme braking. This enables the car to continue being steered and therefore controlled during this braking incident. The DS 3's ABS system is further enhanced with EBA and EBD.

## › ELECTRONIC BRAKEFORCE DISTRIBUTION (EBD)

A conventional ABS system cannot account for any of the four wheels wanting to lock more quickly than the others (for example, two of the wheels may be on snow and two on tarmac). EBD reads the deceleration rate of each wheel individually and applies the ABS principles accordingly.

## › EMERGENCY BRAKING ASSISTANCE (EBA)

As drivers we find it difficult to instinctively brake very hard, but this is often what is needed in those rare emergency situations. The EBA system recognises our 'attempt' to brake hard and in combination with the ABS and EBD systems instantly applies the maximum stopping power possible.

## › ELECTRONIC STABILITY CONTROL (ESC)

This is computer-controlled traction assistance and is provided primarily through the braking systems. The ESC's control unit constantly compares where the driver intends going (through the position of the steering wheel) with where the vehicle is actually going and, if necessary, makes speed corrections to each wheel individually through braking or engine torque to keep the vehicle 'in line'.

## › EMYWAY SATELLITE NAVIGATION SYSTEM

The eMyWay satellite navigation system features a 7 inch screen and covers UK and Europe. Its in-built memory provides information about speed limits and lets you know which lane to use when reaching complex intersections. The system also lets you adapt your route based on traffic conditions, with data provided by Trafficmaster and ViaMichelin in the UK and France.

## › ON-BOARD TRIP COMPUTER

The DS 3's multi-function on-board trip computer provides you with information at your fingertips. At the touch of a button you can view a range of data like fuel consumption, average speed and mileage possible at your current fuel level.

## › VARIABLE POWER ASSISTED STEERING

A system that provides extra power assistance for a vehicle's steering at low speeds (such as turning a sharp corner) and less assistance during high-speed situations.

## › CITROËN ETOUCH EMERGENCY AND ASSISTANCE SYSTEM

In the event of an accident or sudden health problem, one push of the 'SOS' button will instantly contact the emergency services. If there's a more serious incident, SOS activates automatically. After a breakdown, one push on the 'chevron' button will alert Citroën Assistance, sending both location details and an initial fault report.

## › RADIO DATA SYSTEM (RDS)

Traffic information on FM radio, allowing the station name and other information to be transmitted alongside audio information.

## › FRONT SEAT BELT PRE-TENSIONERS

In the event of a crash, a pre-tensioner will tighten the seat belt almost instantaneously. This reduces the load on the occupant in a violent crash. Like airbags, pre-tensioners are triggered by sensors in the car's body, and use explosively expanding gas to drive a piston that retracts the belt. Seat belt pre-tensioners also lower the risk of 'submarining', which is when a passenger slides forward under a loosely worn seat belt.

## › ISOFIX

A standardised and more simple method for installing child seats, each seat is 'clicked' into place via a three point system. On DS 3, Isofix is installed on the outer rear seats.

# DIMENSIONS

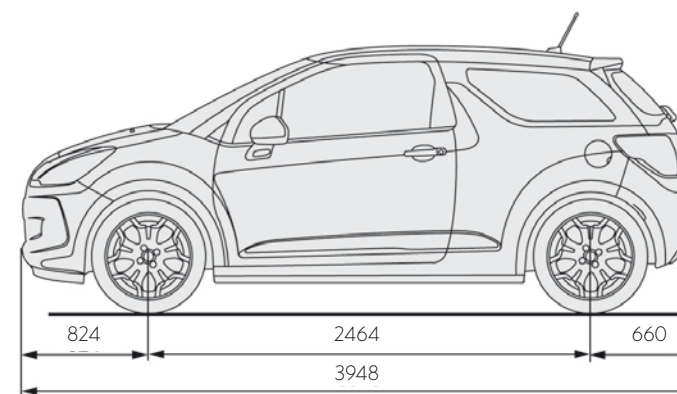
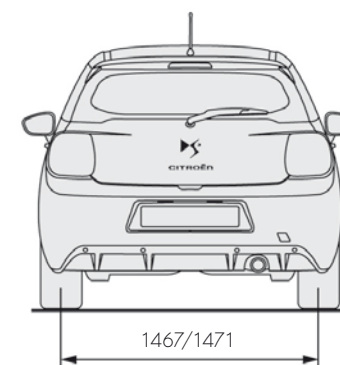
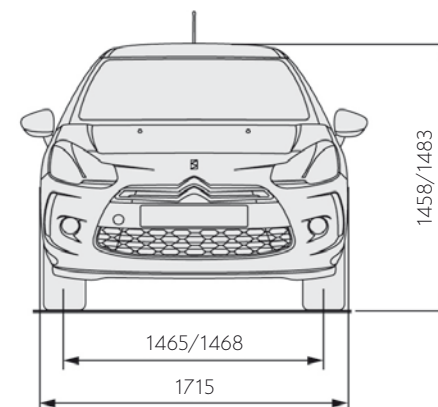

All measurements are in millimetres.



This brochure is made from paper from a well-managed forest. Citroën support responsible use of forest resources.

Please don't throw me away, give me to a friend or recycle me.

NOTE: Every endeavour has been made to ensure that the information and details contained in this brochure were accurate at the time of going to press July 2014. However the company reserves the right, whilst preserving the essential characteristics of the models described, to introduce at any time modifications, changes of details, equipment or accessories. Every effort will be made to bring this brochure up to date, but in order to avoid any misunderstandings please consult your Dealer. For full details of Citroën Care for Car and Driver, please see the full manufacturer's price list. The Citroën Website contains full information on all Citroën products and offers available in the UK, together with details of our environmental and recycling policies. The site address is: [www.citroen.co.uk](http://www.citroen.co.uk) or you can contact Citroën directly via [cuk\\_contactcentre@citroen.com](mailto:cuk_contactcentre@citroen.com)

**CITROËN** prefers **TOTAL**

**CITROËN UK Ltd.** Pinley House, 2 Sunbeam Way, Coventry CV3 1ND.

[www.citroen.co.uk](http://www.citroen.co.uk)

Designed and produced by Acuity

[www.weareacuity.com](http://www.weareacuity.com)

K12398 July 2014



CITROËN DS3  
'TOUCH' BROCHURE



# NOW IT'S YOUR TURN. EVERY ASPECT OF CITROËN DS3 AND DS3 CABRIO IS DESIGNED TO INVOLVE YOU IN THE CREATIVE PROCESS.

THIS IS A GUIDE TO HOW THE HUGE AND DIVERSE RANGE OF OPTIONS WORK TOGETHER IN 10 'TOUCH' PACKAGES, EACH OFFERING A DIFFERENT MIX OF COLOUR, TEXTURE AND TECHNOLOGY ON THE SEVEN CITROËN DS3 MODELS. YOU DON'T REALLY NEED TO BE A MATHEMATICIAN TO SEE THAT THERE IS A FULL SPECTRUM OF INGENUOUS, FRESH PERSONAL ALTERNATIVES AVAILABLE HERE: ALL YOU HAVE TO DO IS LET YOUR IMAGINATION RUN WILD...





# CITROËN DS3 WHITE 'TOUCH'



- Standard equipment
- ◆ No cost option
- Optional factory fitted equipment

○ Not available on this colour 'Touch' models but might be available with other colours.

All prices shown are the Manufacturer's recommended retail prices and include V.A.T.

- 1 Available only as part of optional Intro Signature.
- 2 Standard alloys with black centre cap on DStyle models.
- 3 When optional Leather Pack is ordered, leather gear knob cap is present on manual models.
- 4 Coloured gear knob cap not available on automatic models.
- 5 eMyWay Signature and white dashboard are not compatible.
- 6 When optional Mistral 'Akinen' cloth and Mistral Alcantara® is ordered, heightadjustable front passenger seat and aluminium pedals are present.
- 7 Not available with Whisper Purple, Belle Ile Blue, Sport Red, Sport Yellow, Hickory Brown or Ruby Red body colours and Moon dust Grey roof configurations.
- 8 Mobile phone compatibility can vary by phone manufacturer. Please consult your Dealer for further compatibility information.
- 9 On DSign models, Connect and Intro Signatures are not compatible.
- 10 Connect Signature is incompatible with eMyWay Signature and eMyWay City Signature. In order to get the Hi-Fi system upgrade, please order either Connect Signature, eMyWay City Signature or Hi-Fi system upgrade.
- 11 Not available with Ruby Red body colour.
- 12 Not available with Belle Ile Blue, Sport Yellow and Hickory Brown body colours, Sport Red/Black roof, Shark Grey monotone combinations or with Infinite Blue roof. Only available with Ruby Red if Moon dust roof is ordered.

	DSign	DStyle 91g	DStyle	DSport
<b>'TOUCH' SUMMARY</b>				
White painted door mirrors	●	●	●	●
Chrome door mirrors		£100	£100	£100
16" 'Nuclear' wheel covers (set of four) with white centre caps	●			
16" 'Airflow' wheel covers (set of four) with grey centre caps		●		
16" 'Ashera' alloy wheels (set of four) with white centre caps	○ <sup>1</sup>		● <sup>2</sup>	
16" White 'Ashera' alloy wheels (set of four) with white centre caps	£500		£100	
16" Black 'Ashera' alloy wheels (set of four) with white centre caps	£500		£100	
16" Infinite Blue 'Ashera' alloy wheels (set of four) with Infinite Blue centre caps				
17" Moon dust Grey 'Bellone' alloy wheels (set of four) with white centre caps			£200	◆
17" Black 'Bellone' alloy wheels (set of four) with white centre caps			£300	●
17" White 'Bellone' alloy wheels (set of four) with white centre caps			£300	◆
Aluminium effect dashboard with black gear knob cap <sup>3</sup>	●			
Gloss black dashboard with black gear knob cap <sup>3/4</sup>	£150	●	●	£150
Carbon fibre effect dashboard with black gear knob cap <sup>3</sup>	£150	£150	£150	●
White dashboard with white gear knob cap <sup>3/4/5</sup>	£150	£150	£150	£150
Infinite Blue dashboard with Infinite Blue gear knob cap		£150	£150	£150
Moon dust Grey dashboard with Moon dust Grey gear knob cap				
Mistral 'Sturm' cloth	●			
Mistral 'Rayados' cloth		●	●	
Mistral 'Akinen' cloth and Mistral Alcantara® <sup>6</sup>	£600	£450	£450	●
Mistral 'Akinen' cloth and 'Infinite Blue' Alcantara®		£450	£450	£450
Mistral 'Akinen' cloth and 'Brun Chic' Alcantara®		£450	£450	£450
<b>Black Leather Pack<sup>3</sup></b>	£1,100	£1,100	£1,100	£850
Leather gear knob				
Black leather sport seats and leather door panels				
<b>Granite Blue Leather Pack<sup>3/7</sup></b>		£1,100	£1,100	£850
Leather gear knob				
Granite Blue leather sport seats and leather door panels				
<b>Grey/Black Leather Pack<sup>3</sup></b>		£1,100	£1,100	£850
Leather gear knob				
Grey/black leather sport seats and leather door panels				
<b>Connect Signature</b>	£800			●
Air conditioning		●	●	
Connecting Box (Bluetooth® system with USB socket) <sup>8/9/10</sup>		●	●	
Hi-Fi system audio upgrade		£200	£200	●

	DSign	DStyle 91g	DStyle	DSport
<b>BODY COLOUR SUMMARY</b>				
Polar White	●	●	●	
Shark Grey (metallic)	£745	£675	£675	£495
Arctic Steel (metallic)	£745	£675	£675	£495
Belle Ile Blue (metallic)	£745	£675	£675	£495
Ink Blue (metallic)	£745	£675	£675	£495
Whisper Purple (metallic)		£675	£675	£495
Ruby Red (metallic)	£745	£675	£675	£495
Perla Nera Black (metallic)	£745	£675	£675	£495
Hickory Brown (metallic)	£745	£675	£675	£495

	DSign	DStyle 91g	DStyle	DSport
<b>'TOUCH' SUMMARY</b>				
<b>eMyWay Signature</b>	£1,100	£850	£850	£800
Automatic digital air conditioning				●
Colour satellite navigation, live traffic information, European mapping and Connecting Box (Bluetooth® system with USB socket) <sup>5/8/10</sup>				
<b>eMyWay City Signature</b>	£1,600	£1,350	£1,350	£1,150
Interior mood lighting		●	●	●
Connecting Box (Bluetooth® system with USB socket) and Hi-Fi system				●
Automatic digital air conditioning				●
Automatic illumination of headlamps, automatic rain-sensitive windscreen wipers, electrochromic rear view mirror, rear parking sensors, front central armrest, electrically heated and folding door mirrors, eMyWay Signature and gloss black dashboard <sup>5/8/10</sup>				
<b>City Signature</b>	£1,100	£650	£650	£450
Interior mood lighting		●	●	●
Automatic digital air conditioning				●
Automatic illumination of headlamps, automatic rain-sensitive windscreen wipers, electrochromic rear view mirror, rear parking sensors, front central armrest and electrically heated and folding door mirrors				
<b>Intro Signature</b>	£700			
Air conditioning				●
16" 'Ashera' alloy wheels (set of four) with white centre caps <sup>1/9</sup>				●
<b>LED Signature</b>	£300	●	●	●
Daytime-running LEDs, front fog lights and grille chrome surrounds and chrome insert on rear number plate moulding				
Air conditioning	£550	●	●	
Dark tinted rear windows		●	●	●
Space saver spare wheel	£75	£75	£75	●
'Zebra' Spirit – 'Zebra' roof stickers and carpet mats	£400	£400	£400	£400
'Pearl' Spirit – 'Pearl' roof stickers and carpet mats				
'Urban Tribe' Spirit – 'Urban Tribe' roof stickers and carpet mats				
'Plane' Spirit – 'Plane' roof stickers and carpet mats <sup>11</sup>	£400	£400	£400	£400
'Co-Design' Spirit – 'Co-Design' roof stickers and carpet mats	£400	£400	£400	£400
'Flower' Spirit – 'Flower' roof stickers and carpet mats	£400	£400	£400	£400
'Graphic Art' Spirit – 'Graphic Art' roof stickers and carpet mats <sup>12</sup>	£400	£400	£400	£400

	DSign	DStyle 91g	DStyle	DSport
<b>BODY COLOUR SUMMARY</b>				
Polar White	£745	£180	£180	•
Shark Grey (metallic)	£745	£675	£675	£495
Arctic Steel (metallic)	£745	£675	£675	£495
Perla Nera Black (metallic)	£745	£675	£675	£495



# CITROËN DS3 INFINITE BLUE 'TOUCH'

	DSign	DStyle 91g	DStyle	DSport
<b>'TOUCH' SUMMARY</b>				
Infinite Blue painted door mirrors	•	•	•	•
Chrome door mirrors		£100	£100	£100
16" 'Nuclear' wheel covers (set of four) with Infinite Blue centre caps	•			
16" 'Airflow' wheel covers (set of four) with grey centre caps <sup>1</sup>		•		
16" 'Ashera' alloy wheels (set of four) with Infinite Blue centre caps	o <sup>1</sup>		• <sup>2</sup>	
16" White 'Ashera' alloy wheels (set of four) with Infinite Blue centre caps	£500		£100	
16" Black 'Ashera' alloy wheels (set of four) with Infinite Blue centre caps	£500		£100	
16" Infinite Blue 'Ashera' alloy wheels (set of four) with Infinite Blue centre caps			£100	
17" Black 'Bellone' alloy wheels (set of four) with Infinite Blue centre caps			£300	•
17" White 'Bellone' alloy wheels (set of four) with Infinite Blue centre caps			£300	◆
Aluminium effect dashboard with black gear knob cap <sup>3</sup>	•			
Gloss black dashboard with black gear knob cap <sup>3/4</sup>	£150	•	•	£150
Carbon fibre effect dashboard with black gear knob cap <sup>3</sup>	£150	£150	£150	•
Infinite Blue dashboard with Infinite Blue gear knob cap <sup>3/4/5</sup>		£150	£150	£150
Moondust Grey dashboard with Moondust Grey gear knob cap				
Mistral 'Sturm' cloth	•			
Mistral 'Rayados' cloth		•	•	
Mistral 'Akinen' cloth and Mistral Alcantara <sup>6/7</sup>	£600	£450	£450	•
Mistral 'Akinen' cloth and 'Infinite Blue' Alcantara <sup>6</sup>		£450	£450	£450
Mistral 'Akinen' cloth and 'Brun Chic' Alcantara <sup>6</sup>				
<b>Black Leather Pack<sup>3</sup></b>	£1,100	£1,100	£1,100	£850
Leather gear knob				
Black leather sport seats and leather door panels				
<b>Granite Blue Leather Pack<sup>3</sup></b>		£1,100	£1,100	£850
Leather gear knob				
Granite Blue leather sport seats and leather door panels				
<b>Grey/Black Leather Pack<sup>3</sup></b>		£1,100	£1,100	£850
Leather gear knob				
Grey/Black leather sport seats and leather door panels				
<b>Connect Signature</b>	£800			•
Air conditioning		•	•	
Connecting Box (Bluetooth <sup>®</sup> system with USB socket) <sup>5/9/10</sup>		•	•	
Hi-Fi system audio upgrade		£200	£200	•

	DSign	DStyle 91g	DStyle	DSport
<b>'TOUCH' SUMMARY</b>				
<b>eMyWay Signature</b>	£1,100	£850	£850	£800
Automatic digital air conditioning				•
Colour satellite navigation, live traffic information, European mapping and Connecting Box (Bluetooth <sup>®</sup> system with USB socket) <sup>5/9/10</sup>				
<b>eMyWay City Signature</b>	£1,600	£1,350	£1,350	£1,150
Interior mood lighting		•	•	•
Connecting Box (Bluetooth <sup>®</sup> system with USB socket) and Hi-Fi system				•
Automatic digital air conditioning				•
Automatic illumination of headlamps, automatic rain-sensitive windscreen wipers, electrochromic rear view mirror, rear parking sensors, front central armrest, electrically heated and folding door mirrors, eMyWay Signature and gloss black dashboard <sup>5/9/10</sup>				
<b>City Signature</b>	£1,100	£650	£650	£450
Interior mood lighting		•	•	•
Automatic digital air conditioning				•
Automatic illumination of headlamps, automatic rain-sensitive windscreen wipers, electrochromic rear view mirror, rear parking sensors, front central armrest and electrically heated and folding door mirrors				
<b>Intro Signature</b>	£700			
Air conditioning			•	
16" 'Ashera' alloy wheels (set of four) with Infinite Blue centre caps <sup>9</sup>			•	
<b>LED Signature</b>	£300	•	•	•
Daytime-running LEDs, front fog lights and grille chrome surrounds and chrome insert on rear number plate moulding				
Air conditioning	£550	•	•	
Dark tinted rear windows		•	•	•
Space saver spare wheel	£75	£75	£75	•
<b>'Zebra' Spirit</b> – 'Zebra' roof stickers and carpet mats				
<b>'Pearl' Spirit</b> – 'Pearl' roof stickers and carpet mats				
<b>'Urban Tribe' Spirit</b> – 'Urban Tribe' roof stickers and carpet mats	£400	£400	£400	£400
<b>'Plane' Spirit</b> – 'Plane' roof stickers and carpet mats				
<b>'Co-Design' Spirit</b> – 'Co-Design' roof stickers and carpet mats				
<b>'Flower' Spirit</b> – 'Flower' roof stickers and carpet mats	£400	£400	£400	£400

- Standard equipment
- ◆ No cost option
- o Optional factory fitted equipment
- Not available on this colour 'Touch' models but might be available with other colours.

All prices shown are the Manufacturer's recommended retail prices and include V.A.T.

- <sup>1</sup> Available only as part of optional Intro Signature.
- <sup>2</sup> Standard alloys with black centre cap on DStyle models.
- <sup>3</sup> When optional Leather Pack is ordered, leather gear knob cap is present on manual models.
- <sup>4</sup> Coloured gear knob cap not available on automatic models.
- <sup>5</sup> eMyWay Signature and white or Infinite Blue dashboards are not compatible.
- <sup>6</sup> Available only with Polar White body colour.
- <sup>7</sup> When optional Mistral 'Akinen' cloth and Mistral Alcantara<sup>®</sup> is ordered, height-adjustable front passenger seat and aluminium pedals are present.
- <sup>8</sup> Mobile phone compatibility can vary by phone manufacturer. Please consult your Dealer for further compatibility information.
- <sup>9</sup> On DSign models, Connect and Intro Signatures are not compatible.
- <sup>10</sup> Connect Signature is incompatible with eMyWay Signature and eMyWay City Signature. In order to get the Hi-Fi system upgrade, please order either Connect Signature, eMyWay City Signature or Hi-Fi system upgrade.

# CITROËN DS3 MOONDUST GREY 'TOUCH'



- Standard equipment
- ◆ No cost option
- Optional factory fitted equipment

Not available on this colour 'Touch' models but might be available with other colours.

All prices shown are the Manufacturer's recommended retail prices and include V.A.T.

<sup>1</sup> Available only as part of optional Intro Signature.

<sup>2</sup> Standard alloys with black centre cap on DStyle models.

<sup>3</sup> When optional Leather Pack is ordered, leather gear knob cap is present on manual models.

<sup>4</sup> Coloured gear knob cap not available on automatic models.

<sup>5</sup> eMyWay Signature and white or Moondust Grey dashboards are not compatible.

<sup>6</sup> Available only with Polar White body colour.

<sup>7</sup> When optional Mistral 'Akinen' cloth and Mistral Alcantara® is ordered, height-adjustable front passenger seat and aluminium pedals are present.

<sup>8</sup> Granite Blue leather not available with Whisper Purple, Belle Ile Blue, Sport Red, Sport Yellow, Hickory Brown or Ruby Red body colours and Moondust Grey roof configurations.

<sup>9</sup> Mobile phone compatibility can vary by phone manufacturer. Please consult your Dealer for further compatibility information.

<sup>10</sup> On DSign models, Connect and Intro Signatures are not compatible.

<sup>11</sup> Connect Signature is incompatible with eMyWay Signature and eMyWay City Signature. In order to get the Hi-Fi system upgrade, please order either Connect Signature, eMyWay City Signature or Hi-Fi audio upgrade.

<sup>12</sup> Not available with Sport Yellow, Belle Ile Blue and Hickory Brown body colours, Sport Red/Black roof, Shark Grey monotone combinations or with Infinite Blue roof. Only available with Ruby Red if Moondust roof is ordered.

	DSign	DStyle 91g	DStyle	DSport
<b>'TOUCH' SUMMARY</b>				
Moondust Grey painted door mirrors	●	●	●	●
Chrome door mirrors		£100	£100	£100
16" 'Nuclear' wheel covers with Moondust Grey centre caps	●			
16" 'Airflow' wheel covers (set of four) with grey centre caps		●		
16" 'Ashera' alloy wheels (set of four) with Moondust Grey centre caps	○ <sup>1</sup>		● <sup>2</sup>	
16" White 'Ashera' alloy wheels (set of four) with Moondust Grey centre caps	£500		£100	
16" Black 'Ashera' alloy wheels (set of four) with Moondust Grey centre caps	£500		£100	
16" Infinite Blue 'Ashera' alloy wheels (set of four) with black centre caps				
17" Moondust Grey 'Bellone' alloy wheels (set of four) with black centre caps			£200	◆
17" Black 'Bellone' alloy wheels (set of four) with Moondust Grey centre caps			£300	●
17" White 'Bellone' alloy wheels (set of four) with Moondust Grey centre caps			£300	◆
Aluminium effect dashboard with black gear knob cap <sup>3</sup>	●			
Gloss black dashboard with black gear knob cap <sup>3/4</sup>	£150	●	●	£150
Carbon fibre effect dashboard with black gear knob cap <sup>3</sup>	£150	£150	£150	●
White dashboard with white gear knob cap <sup>3/4/5/6</sup>	£150	£150	£150	£150
Infinite Blue dashboard with Infinite Blue gear knob cap				
Moondust Grey dashboard with Moondust Grey gear knob cap <sup>3/4/5</sup>		£150	£150	£150
Mistral 'Sturm' cloth	●			
Mistral 'Rayados' cloth		●	●	
Mistral 'Akinen' cloth and Mistral Alcantara® <sup>7</sup>	£600	£450	£450	●
Mistral 'Akinen' cloth and 'Infinite Blue' Alcantara®				
Mistral 'Akinen' cloth and 'Brun Chic' Alcantara®				
<b>Black Leather Pack<sup>3</sup></b>	£1,100	£1,100	£1,100	£850
Leather gear knob				
Black leather sport seats and leather door panels				
<b>Granite Blue Leather Pack<sup>3/8</sup></b>				
Leather gear knob				
Granite Blue leather sport seats and leather door panels				
<b>Grey/Black Leather Pack<sup>3</sup></b>		£1,100	£1,100	£850
Leather gear knob				
Grey/Black leather sport seats and leather door panels				
<b>Connect Signature</b>	£800			●
Air conditioning		●	●	
Connecting Box [Bluetooth® system with USB socket] <sup>9/10/11</sup>		●	●	
Hi-Fi system audio upgrade		£200	£200	●

	DSign	DStyle 91g	DStyle	DSport
<b>BODY COLOUR SUMMARY</b>				
Polar White		£180	£180	●
Perla Nera Black (metallic)	£745	£675	£675	£495
Ink Blue (metallic)		£675	£675	£495
Whisper Purple (metallic)		£675	£675	£495
Ruby Red (metallic)		£675	£675	£495

	DSign	DStyle 91g	DStyle	DSport
<b>'TOUCH' SUMMARY</b>				
<b>eMyWay Signature</b>	£1,100	£850	£850	£800
Automatic digital air conditioning				●
Colour satellite navigation, live traffic information, European mapping and Connecting Box [Bluetooth® system with USB socket] <sup>5/9/11</sup>				
<b>eMyWay City Signature</b>	£1,600	£1,350	£1,350	£1,150
Interior mood lighting		●	●	●
Connecting Box [Bluetooth® system with USB socket] and Hi-Fi system				●
Automatic digital air conditioning				●
Automatic illumination of headlamps, automatic rain-sensitive windscreen wipers, electrochromic rear view mirror, rear parking sensors, front central armrest, electrically heated and folding door mirrors, eMyWay Signature and gloss black dashboard <sup>5/9/11</sup>				
<b>City Signature</b>	£1,100	£650	£650	£450
Interior mood lighting		●	●	●
Automatic digital air conditioning				●
Automatic illumination of headlamps, automatic rain-sensitive windscreen wipers, electrochromic rear view mirror, rear parking sensors, front central armrest and electrically heated and folding door mirrors				
<b>Intro Signature</b>	£700			
Air conditioning				●
16" 'Ashera' alloy wheels (set of four) with Moondust Grey centre caps <sup>10</sup>				●
<b>LED Signature</b>	£300	●	●	●
Daytime-running LEDs, front fog lights and grille chrome surrounds and chrome insert on rear number plate moulding				
Air conditioning	£550	●	●	
Dark tinted rear windows		●	●	●
Space saver spare wheel	£75	£75	£75	●
<b>'Zebra' Spirit</b> – 'Zebra' roof stickers and carpet mats	£400	£400	£400	£400
<b>'Pearl' Spirit</b> – 'Pearl' roof stickers and carpet mats				
<b>'Urban Tribe' Spirit</b> – 'Urban Tribe' roof stickers and carpet mats	£400	£400	£400	£400
<b>'Plane' Spirit</b> – 'Plane' roof stickers and carpet mats				
<b>'Co-Design' Spirit</b> – 'Co-Design' roof stickers and carpet mats				
<b>'Flower' Spirit</b> – 'Flower' roof stickers and carpet mats	£400	£400	£400	£400
<b>'Graphic Art' Spirit</b> – 'Graphic Art' roof stickers and carpet mats <sup>12</sup>	£400	£400	£400	£400



# CITROËN DS3 BLACK 'TOUCH'

## BODY COLOUR SUMMARY

	DSign	DStyle 91g	DStyle	DSport
Polar White	£250	£180	£180	•
Shark Grey (metallic)	£745	£675	£675	£495
Arctic Steel (metallic)	£745	£675	£675	£495
Belle Ile Blue (metallic)	£745	£675	£675	£495
Ink Blue (metallic)	£745	£675	£675	£495
Whisper Purple (metallic)	£745	£675	£675	£495
Ruby Red (metallic)	£745	£675	£675	£495
Perla Nera Black (metallic)	£495	£495	£495	£495
Hickory Brown (metallic)	£745	£675	£675	£495

## 'TOUCH' SUMMARY

	DSign	DStyle 91g	DStyle	DSport
Black painted door mirrors	•	•	•	•
Chrome door mirrors		£100	£100	£100
16" 'Nuclear' wheel covers (set of four) with black centre caps	•			
16" 'Airflow' wheel covers (set of four) with grey centre caps		•		
16" 'Ashera' alloy wheels (set of four) with black centre caps	o <sup>1</sup>		• <sup>2</sup>	
16" White 'Ashera' alloy wheels (set of four) with black centre caps	£500		£100	
16" Black 'Ashera' alloy wheels (set of four) with black centre caps	£500		£100	
16" Infinite Blue 'Ashera' alloy wheels (set of four) with black centre caps				
17" Moondust Grey 'Bellone' alloy wheels (set of four) with black centre caps			£200	♦
17" Black 'Bellone' alloy wheels (set of four) with black centre caps			£300	•
17" White 'Bellone' alloy wheels (set of four) with black centre caps			£300	♦
Aluminium effect dashboard with black gear knob cap <sup>3</sup>	•			
Gloss black dashboard with black gear knob cap <sup>3/4</sup>	£150	•	•	£150
Carbon fibre effect dashboard with black gear knob cap <sup>3</sup>	£150	£150	£150	•
White dashboard with white gear knob cap <sup>3/4/5</sup>	£150	£150	£150	£150
Infinite Blue dashboard with Infinite Blue gear knob cap				
Moondust Grey dashboard with Moondust Grey gear knob cap		£150	£150	£150
Mistral 'Sturm' cloth	•			
Mistral 'Rayados' cloth		•	•	
Mistral 'Akinen' cloth and Mistral Alcantara <sup>6/7</sup>	£600	£450	£450	•
Mistral 'Akinen' cloth and 'Infinite Blue' Alcantara <sup>8</sup>				
Mistral 'Akinen' cloth and 'Brun Chic' Alcantara <sup>9</sup>		£450	£450	£450
<b>Black Leather Pack<sup>3</sup></b>	£1,100	£1,100	£1,100	£850
Leather gear knob				
Black leather sport seats and leather door panels				
<b>Granite Blue Leather Pack<sup>3/8</sup></b>		£1,100	£1,100	£850
Leather gear knob				
Granite Blue leather sport seats and leather door panels				
<b>Grey/Black Leather Pack<sup>3</sup></b>		£1,100	£1,100	£850
Leather gear knob				
Grey/Black leather sport seats and leather door panels				
<b>Connect Signature</b>	£800			•
Air conditioning		•	•	
Connecting Box (Bluetooth <sup>®</sup> system with USB socket) <sup>9/10/11</sup>		•	•	
Hi-Fi system audio upgrade		£200	£200	•

## 'TOUCH' SUMMARY

	DSign	DStyle 91g	DStyle	DSport
<b>eMyWay Signature</b>	£1,100	£850	£850	£800
Automatic digital air conditioning				•
Colour satellite navigation, live traffic information, European mapping and Connecting Box (Bluetooth <sup>®</sup> system with USB socket) <sup>5/9/11</sup>				
<b>eMyWay City Signature</b>	£1,600	£1,350	£1,350	£1,150
Interior mood lighting		•	•	•
Connecting Box (Bluetooth <sup>®</sup> system with USB socket) and Hi-Fi system				•
Automatic digital air conditioning				•
Automatic illumination of headlamps, automatic rain-sensitive windscreen wipers, electrochromic rear view mirror, rear parking sensors, front central armrest, electrically heated and folding door mirrors, eMyWay Signature and gloss black dashboard <sup>5/9/11</sup>				•
<b>City Signature</b>	£1,100	£650	£650	£450
Interior mood lighting		•	•	•
Automatic digital air conditioning				•
Automatic illumination of headlamps, automatic rain-sensitive windscreen wipers, electrochromic rear view mirror, rear parking sensors, front central armrest and electrically heated and folding door mirrors				
<b>Intro Signature</b>	£700			
Air conditioning				•
16" 'Ashera' alloy wheels (set of four) with black centre caps <sup>10</sup>				•
<b>LED Signature</b>	£300	•	•	•
Daytime-running LEDs, front fog lights and grille chrome surrounds and chrome insert on rear number plate moulding				
Air conditioning	£550	•	•	
Dark tinted rear windows		•	•	•
Space saver spare wheel	£75	£75	£75	•
<b>'Zebra' Spirit</b> – 'Zebra' roof stickers and carpet mats	£400	£400	£400	£400
<b>'Pearl' Spirit</b> – 'Pearl' roof stickers and carpet mats	£400	£400	£400	£400
<b>'Urban Tribe' Spirit</b> – 'Urban Tribe' roof stickers and carpet mats	£400	£400	£400	£400
<b>'Plane' Spirit</b> – 'Plane' roof stickers and carpet mats <sup>12</sup>	£400	£400	£400	£400
<b>'Co-Design' Spirit</b> – 'Co-Design' roof stickers and carpet mats				
<b>'Flower' Spirit</b> – 'Flower' roof stickers and carpet mats	£400	£400	£400	£400
<b>'Graphic Art' Spirit</b> – 'Graphic Art' roof stickers and carpet mats <sup>13</sup>	£400	£400	£400	£400

- Standard equipment
- ♦ No cost option
- o Optional factory fitted equipment
- Not available on this colour 'Touch' models but might be available with other colours.

All prices shown are the Manufacturer's recommended retail prices and include V.A.T.

- 1 Available only as part of optional Intro Signature.
- 2 Standard alloys with black centre cap on DStyle models.
- 3 When optional Leather Pack is ordered, leather gear knob cap is present on manual models.
- 4 Coloured gear knob cap not available on automatic models.
- 5 eMyWay Signature and white dashboard are not compatible.
- 6 Available only with Polar White/Perla Nera Black body colour two tone configurations excluding Infinite Blue.
- 7 When optional Mistral 'Akinen' cloth and Mistral Alcantara<sup>®</sup> is ordered, height-adjustable front passenger seat and aluminium pedals are present.
- 8 Granite Blue leather not available with Belle Ile Blue, Whisper Purple, Sport Red, Sport Yellow, Hickory Brown or Ruby Red body colours and Moondust Grey roof configurations.
- 9 Mobile phone compatibility can vary by phone manufacturer. Please consult your Dealer for further compatibility information.
- 10 On DSign models, Connect and Intro Signatures are not compatible.
- 11 Connect Signature is incompatible with eMyWay Signature and eMyWay City Signature. In order to get the Hi-Fi system upgrade, please order either Connect Signature, eMyWay City Signature or Hi-Fi audio upgrade.
- 12 Not available with Ruby Red body colour.
- 13 Not available with Belle Ile Blue, Sport Yellow and Hickory Brown body colours, Sport Red/Black roof, Shark Grey monotone combinations or with Infinite Blue roof. Only available with Ruby Red if Moondust roof is ordered.

# CITROËN DS3 SPORT YELLOW 'TOUCH'

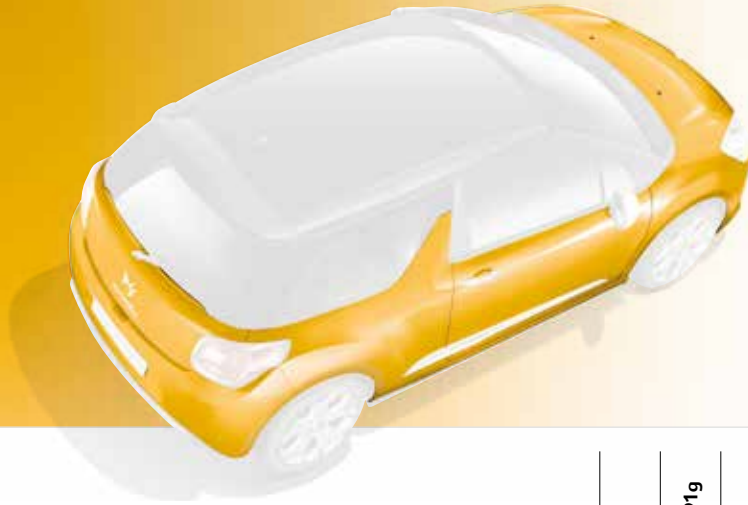

	DSign	DStyle 91g	DStyle	DSport
<b>ROOF COLOUR SUMMARY</b>				
White	£745	£675	£675	£495
Black	£745	£675	£675	£495

- Standard equipment
- ◆ No cost option
- Optional factory fitted equipment
- Not available on this colour 'Touch' models but might be available with other colours.

All prices shown are the Manufacturer's recommended retail prices and include V.A.T.

- 1 Available only as part of optional Intro Signature.
- 2 Standard alloys with black centre cap on DStyle models.
- 3 When optional Leather Pack is ordered, leather gear knob cap is present on manual models.
- 4 Coloured gear knob cap not available on automatic models.
- 5 eMyWay Signature and white dashboard are not compatible.
- 6 Available only with white roof.
- 7 When optional Mistral 'Akinen' cloth and Mistral Alcantara® is ordered, height-adjustable front passenger seat and aluminium pedals are present.
- 8 Granite Blue leather not available with Belle Ile Blue, Whisper Purple, Sport Red, Sport Yellow, Hickory Brown or Ruby Red body colours and Moondust Grey roof configurations.
- 9 Mobile phone compatibility can vary by phone manufacturer. Please consult your Dealer for further compatibility information.
- 10 On DSign models, Connect and Intro Signatures are not compatible.
- 11 Connect Signature is incompatible with eMyWay Signature and eMyWay City Signature. In order to get the Hi-Fi system upgrade, please order either Connect Signature, eMyWay City Signature or Hi-Fi audio upgrade.
- 12 Available only with black roof.

	DSign	DStyle 91g	DStyle	DSport
<b>'TOUCH' SUMMARY</b>				
Roof colour painted door mirrors	●	●	●	●
Chrome door mirrors		£100	£100	£100
16" 'Nuclear' wheel covers (set of four) with roof coloured centre caps	●			
16" 'Airflow' wheel covers (set of four) with grey centre caps		●		
16" 'Ashera' alloy wheels (set of four) with roof coloured centre caps	○ <sup>1</sup>		● <sup>2</sup>	
16" White 'Ashera' alloy wheels (set of four) with roof coloured centre caps	£500		£100	
16" Black 'Ashera' alloy wheels (set of four) with roof coloured centre caps	£500		£100	
16" Infinite Blue 'Ashera' alloy wheels (set of four) with Infinite Blue centre caps				
17" Black 'Bellone' alloy wheels (set of four) with roof coloured centre caps			£300	●
17" White 'Bellone' alloy wheels (set of four) with roof coloured centre caps			£300	◆
Aluminium effect dashboard with black gear knob cap <sup>3</sup>	●			
Gloss black dashboard with black gear knob cap <sup>3/4</sup>	£150	●	●	£150
Carbon fibre effect dashboard with black gear knob cap <sup>3</sup>	£150	£150	£150	●
Infinite Blue dashboard with Infinite Blue gear knob cap				
Moondust Grey dashboard with Moondust Grey gear knob cap				
Mistral 'Sturm' cloth	●			
Mistral 'Rayados' cloth		●	●	
Mistral 'Akinen' cloth and Mistral Alcantara® <sup>7</sup>	£600	£450	£450	●
Mistral 'Akinen' cloth and 'Infinite Blue' Alcantara®				
Mistral 'Akinen' cloth and 'Brun Chic' Alcantara®				
<b>Black Leather Pack<sup>3</sup></b>	£1,100	£1,100	£1,100	£850
Leather gear knob				
Black leather sport seats and leather door panels				
<b>Granite Blue Leather Pack<sup>3/8</sup></b>				
Leather gear knob				
Granite Blue leather sport seats and leather door panels				
<b>Grey/Black Leather Pack<sup>3</sup></b>		£1,100	£1,100	£850
Leather gear knob				
Grey/Black Leather Pack leather sport seats and leather door panels				
<b>Connect Signature</b>	£800			●
Air conditioning		●	●	
Connecting Box (Bluetooth® system with USB socket) <sup>5/9/11</sup>		●	●	
Hi-Fi system audio upgrade		£200	£200	●

	DSign	DStyle 91g	DStyle	DSport
<b>'TOUCH' SUMMARY</b>				
<b>eMyWay Signature</b>	£1,100	£850	£850	£800
Automatic digital air conditioning				●
Colour satellite navigation, live traffic information, European mapping and Connecting Box (Bluetooth® system with USB socket) <sup>5/9/11</sup>				
<b>eMyWay City Signature</b>	£1,600	£1,350	£1,350	£1,150
Interior mood lighting		●	●	●
Connecting Box (Bluetooth® system with USB socket) and Hi-Fi system				●
Automatic digital air conditioning				●
Automatic illumination of headlamps, automatic rain-sensitive windscreen wipers, electrochromic rear view mirror, rear parking sensors, front central armrest, electrically heated and folding door mirrors and eMyWay Signature, gloss black dashboard <sup>5/9/11</sup>				
<b>City Signature</b>	£1,100	£650	£650	£450
Interior mood lighting		●	●	●
Automatic digital air conditioning				●
Automatic illumination of headlamps, automatic rain-sensitive windscreen wipers, electrochromic rear view mirror, rear parking sensors, front central armrest and electrically heated and folding door mirrors				
<b>Intro Signature</b>	£700			
Air conditioning			●	
16" 'Ashera' alloy wheels (set of four) with Sport Yellow centre caps <sup>10</sup>			●	
<b>LED Signature</b>	£300	●	●	●
Daytime-running LEDs, front fog lights and grille chrome surrounds and chrome insert on rear number plate moulding				
Air conditioning	£550	●	●	
Dark tinted rear windows		●	●	●
Space saver spare wheel	£75	£75	£75	●
<b>'Zebra' Spirit</b> – 'Zebra' roof stickers and carpet mats	£400	£400	£400	£400
<b>'Pearl' Spirit</b> – 'Pearl' roof stickers and carpet mats <sup>12</sup>	£400	£400	£400	£400
<b>'Urban Tribe' Spirit</b> – 'Urban Tribe' roof stickers and carpet mats <sup>12</sup>	£400	£400	£400	£400
<b>'Plane' Spirit</b> – 'Plane' roof stickers and carpet mats	£400	£400	£400	£400
<b>'Co-Design' Spirit</b> – 'Co-Design' roof stickers and carpet mats <sup>6</sup>	£400	£400	£400	£400
<b>'Flower' Spirit</b> – 'Flower' roof stickers and carpet mats	£400	£400	£400	£400

	DSign	DStyle 91g	DStyle	DSport
<b>ROOF COLOUR SUMMARY</b>				
White	£745	£675	£675	£495
Black	£745	£675	£675	£495



# CITROËN DS3 SPORT RED 'TOUCH'

	DSign	DStyle 91g	DStyle	DSport
<b>'TOUCH' SUMMARY</b>				
Roof colour painted door mirrors	•	•	•	•
Chrome door mirrors		£100	£100	£100
16" 'Nuclear' wheel covers (set of four) with roof coloured centre caps	•			
16" 'Airflow' wheel covers (set of four) with grey centre caps		•		
16" 'Ashera' alloy wheels (set of four) with roof coloured centre caps	o <sup>1</sup>		• <sup>2</sup>	
16" White 'Ashera' alloy wheels (set of four) with roof coloured centre caps	£500		£100	
16" Black 'Ashera' alloy wheels (set of four) with roof coloured centre caps	£500		£100	
16" Infinite Blue 'Ashera' alloy wheels (set of four) with Infinite Blue centre caps				
17" Black 'Bellone' alloy wheels (set of four) with roof coloured centre caps			£300	•
17" White 'Bellone' alloy wheels (set of four) with roof coloured centre caps			£300	◆
Aluminium effect dashboard with black gear knob cap <sup>3</sup>	•			
Gloss black dashboard with black gear knob cap <sup>3/4</sup>	£150	•	•	£150
Carbon fibre effect dashboard with black gear knob cap <sup>3</sup>	£150	£150	£150	•
Infinite Blue dashboard with Infinite Blue gear knob cap				
Moon dust Grey dashboard with Moon dust Grey gear knob cap				
Mistral 'Sturm' cloth	•			
Mistral 'Rayados' cloth		•	•	
Mistral 'Akinen' cloth and Mistral Alcantara <sup>8/7</sup>	£600	£450	£450	•
Mistral 'Akinen' cloth and 'Infinite Blue' Alcantara <sup>8</sup>				
Mistral 'Akinen' cloth and 'Brun Chic' Alcantara <sup>8</sup>				
<b>Black Leather Pack<sup>3</sup></b>	£1,100	£1,100	£1,100	£850
Leather gear knob				
Black leather sport seats and leather door panels				
<b>Granite Blue Leather Pack<sup>3/8</sup></b>				
Leather gear knob				
Granite Blue leather sport seats and leather door panels				
<b>Grey/Black 'Claudia' Leather Pack<sup>3</sup></b>		£1,100	£1,100	£850
Leather gear knob				
Grey/Black perforated 'Claudia' leather sport seats and leather door panels				
<b>Connect Signature</b>	£800			•
Air conditioning		•	•	
Connecting Box (Bluetooth <sup>®</sup> system with USB socket) <sup>5/9/11</sup>		•	•	
Hi-Fi system audio upgrade		£200	£200	•

	DSign	DStyle 91g	DStyle	DSport
<b>'TOUCH' SUMMARY</b>				
<b>eMyWay Signature</b>	£1,100	£850	£850	£800
Automatic digital air conditioning				•
Colour satellite navigation, live traffic information, European mapping and Connecting Box (Bluetooth <sup>®</sup> system with USB socket) <sup>5/9/11</sup>				
<b>eMyWay City Signature</b>	£1,600	£1,350	£1,350	£1,150
Interior mood lighting		•	•	•
Connecting Box (Bluetooth <sup>®</sup> system with USB socket) and Hi-Fi system				•
Automatic digital air conditioning				•
Automatic illumination of headlamps, automatic rain-sensitive wipers, electrochromic rear view mirror, rear parking sensors, front central armrest, electrically heated and folding door mirrors and eMyWay Signature, gloss black dashboard <sup>5/9/11</sup>				•
<b>City Signature</b>	£1,100	£650	£650	£450
Interior mood lighting		•	•	•
Automatic digital air conditioning				•
Automatic illumination of headlamps, automatic rain-sensitive wipers, electrochromic rear view mirror, rear parking sensors, front central armrest and electrically heated and folding door mirrors				
<b>Intro Signature<sup>10</sup></b>	£700			
Air conditioning			•	
16" 'Ashera' alloy wheels (set of four) with Sport Red centre caps			•	
<b>LED Signature</b>	£300	•	•	•
Daytime-running LEDs, front fog lights and grille chrome surrounds and chrome insert on rear number plate moulding				
Air conditioning	£550	•	•	
Dark tinted rear windows		•	•	•
Space saver spare wheel	£75	£75	£75	•
'Zebra' Spirit – 'Zebra' roof stickers and carpet mats	£400	£400	£400	£400
'Pearl' Spirit – 'Pearl' roof stickers and carpet mats <sup>12</sup>	£400	£400	£400	£400
'Urban Tribe' Spirit – 'Urban Tribe' roof stickers and carpet mats <sup>12</sup>	£400	£400	£400	£400
'Plane' Spirit – 'Plane' roof stickers and carpet mats	£400	£400	£400	£400
'Co-Design' Spirit – 'Co-Design' roof stickers and carpet mats <sup>6</sup>	£400	£400	£400	£400
'Flower' Spirit – 'Flower' roof stickers and carpet mats	£400	£400	£400	£400
'Graphic Art' Spirit – 'Graphic Art' roof stickers and carpet mats <sup>13</sup>	£400	£400	£400	£400

- Standard equipment
- ◆ No cost option
- Optional factory fitted equipment
- Not available on this colour 'Touch' models but might be available with other colours.

All prices shown are the Manufacturer's recommended retail prices and include V.A.T.

- 1 Available only as part of optional Intro Signature.
- 2 Standard alloys with black centre cap on DStyle models.
- 3 When optional Leather Pack is ordered, leather gear knob cap is present on manual models.
- 4 Coloured gear knob cap not available on automatic models.
- 5 eMyWay Signature and white dashboard are not compatible.
- 6 Available only with white roof.
- 7 When optional Mistral 'Akinen' cloth and Mistral Alcantara<sup>®</sup> is ordered, height-adjustable front passenger seat and aluminium pedals are present.
- 8 Granite Blue leather not available with Belle Ile Blue, Whisper Purple, Sport Red, Sport Yellow, Hickory Brown or Ruby Red body colours and Moon dust Grey roof configurations.
- 9 Mobile phone compatibility can vary by phone manufacturer. Please consult your Dealer for further compatibility information.
- 10 On DSign models, Connect and Intro Signatures are not compatible.
- 11 Connect Signature is incompatible with eMyWay Signature and eMyWay City Signature. In order to get the Hi-Fi system upgrade, please order either Connect Signature or eMyWay City Signature.
- 12 Available only with black roof.
- 13 Not available with Belle Ile Blue, Sport Yellow and Hickory Brown body colours, Sport Red/Black roof, Shark Grey monotone combinations or with Infinite Blue roof. Only available with Ruby Red if Moon dust roof is ordered.

# CITROËN DS3 MONO 'TOUCH'



- Standard equipment
- ◆ No cost option
- Optional factory fitted equipment
- Not available on this colour 'Touch' models but might be available with other colours.

All prices shown are the Manufacturer's recommended retail prices and include V.A.T.

- <sup>1</sup> Available only as part of optional Intro Signature.
- <sup>2</sup> Standard alloys with black centre cap on DStyle models.
- <sup>3</sup> When optional Leather Pack is ordered, leather gear knob cap is present on manual models.
- <sup>4</sup> Coloured gear knob cap not available on automatic models.
- <sup>5</sup> eMyWay Signature and white dashboard are not compatible.
- <sup>6</sup> When optional Mistral 'Akinen' cloth and Mistral Alcantara® is ordered, heightadjustable front passenger seat and aluminium pedals are present.
- <sup>7</sup> Granite Blue leather not available with Belle Ile Blue, Whisper Purple, Sport Red, Sport Yellow, Hickory Brown or Ruby Red body colours and Moon dust Grey roof configurations.
- <sup>8</sup> Mobile phone compatibility can vary by phone manufacturer. Please consult your Dealer for further compatibility information.
- <sup>9</sup> On DSign models, Connect and Intro Signatures are not compatible.
- <sup>10</sup> Connect Signature is incompatible with eMyWay Signature and eMyWay City Signature. In order to get the Hi-Fi system upgrade, please order either Connect Signature, eMyWay City Signature or Hi-Fi audio upgrade
- <sup>11</sup> Not available on Ruby Red monotone.
- <sup>12</sup> Only available on Perla Nera Black monotone
- <sup>13</sup> Not available on Polar White monotone.
- <sup>14</sup> Only available on Shark Grey monotone.
- <sup>15</sup> Only available on Polar White monotone.
- <sup>16</sup> Not available with Belle Ile Blue, Sport Yellow and Hickory Brown body colours, Sport Red/Black roof, Shark Grey monotone combinations or with Infinite Blue roof. Only available with Ruby Red if Moon dust roof is ordered.

	DSign	DStyle 91g	DStyle	DSport
<b>'TOUCH' SUMMARY</b>				
Body colour painted door mirrors	●	●	●	●
Chrome door mirrors		£100	£100	£100
16" 'Nuclear' wheel covers (set of four) with black centre caps	●			
16" 'Airflow' wheel covers (set of four) with grey centre caps		●		
16" 'Ashera' alloy wheels (set of four) with body coloured centre caps	○ <sup>1</sup>		● <sup>2</sup>	
16" White 'Ashera' alloy wheels (set of four) with body coloured centre caps	£500		£100	
16" Black 'Ashera' alloy wheels (set of four) with body coloured centre caps	£500		£100	
16" Infinite Blue 'Ashera' alloy wheels (set of four) with Infinite Blue centre caps				
17" Moon dust Grey 'Bellone' alloy wheels (set of four) with body coloured centre caps			£200	◆
17" Black 'Bellone' alloy wheels (set of four) with body coloured centre caps			£300	●
17" White 'Bellone' alloy wheels (set of four) with body coloured centre caps			£300	◆
Aluminium effect dashboard with black gear knob cap <sup>3</sup>	●			
Gloss black dashboard with black gear knob cap <sup>3/4</sup>	£150	●	●	£150
Carbon fibre effect dashboard with black gear knob cap <sup>3</sup>	£150	£150	£150	●
White dashboard with white gear knob cap <sup>3/4/5</sup>	£150	£150	£150	£150
Infinite Blue dashboard with Infinite Blue gear knob cap				
Moon dust Grey dashboard with Moon dust Grey gear knob cap	£150	£150	£150	
Mistral 'Sturm' cloth	●			
Mistral 'Rayados' cloth		●	●	
Mistral 'Akinen' cloth and Mistral Alcantara® <sup>6</sup>	£600	£450	£450	●
Mistral 'Akinen' cloth and 'Infinite Blue' Alcantara®		£450	£450	£450
Mistral 'Akinen' cloth and 'Brun Chic' Alcantara®		£450	£450	£450
<b>Black Leather Pack<sup>3</sup></b>	£1,100	£1,100	£1,100	£850
Leather gear knob				
Black leather sport seats and leather door panels				
<b>Granite Blue Leather Pack<sup>3/8</sup></b>		£1,100	£1,100	£850
Leather gear knob				
Granite Blue leather sport seats and leather door panels				
<b>Grey/Black Leather Pack<sup>3</sup></b>		£1,100	£1,100	£850
Leather gear knob				
Grey/black leather sport seats and leather door panels				
<b>Connect Signature</b>	£800			●
Air conditioning		●	●	
Connecting Box (Bluetooth® system with USB socket) <sup>8/9/10</sup>		●	●	
Hi-Fi system audio upgrade		£200	£200	●

	DSign	DStyle 91g	DStyle	DSport
<b>BODY COLOUR SUMMARY</b>				
Polar White	●	●	●	
Shark Grey (metallic)	£495	£495	£495	
Ruby Red (metallic)	£495	£495	£495	
Hickory Brown (metallic)	£495	£495	£495	
Perla Nera Black (metallic)	£495	£495	£495	£495

	DSign	DStyle 91g	DStyle	DSport
<b>'TOUCH' SUMMARY</b>				
<b>eMyWay Signature</b>	£1,100	£850	£850	£800
Automatic digital air conditioning				●
Colour satellite navigation, live traffic information, European mapping and Connecting Box (Bluetooth® system with USB socket) <sup>5/8/10</sup>				
<b>eMyWay City Signature</b>	£1,600	£1,350	£1,350	£1,150
Interior mood lighting		●	●	●
Connecting Box (Bluetooth® system with USB socket) and Hi-Fi system				●
Automatic digital air conditioning				●
Automatic illumination of headlamps, automatic rain-sensitive windscreen wipers, electrochrom rear view mirror, rear parking sensors, front central armrest, electrically heated and folding door mirrors, eMyWay Signature and gloss black dashboard <sup>5/8/10</sup>				
<b>City Signature</b>	£1,100	£650	£650	£450
Interior mood lighting		●	●	●
Automatic digital air conditioning				●
Automatic illumination of headlamps, automatic rain-sensitive windscreen wipers, electrochrom rear view mirror, rear parking sensors, front central armrest and electrically heated and folding door mirrors				
<b>Intro Signature</b>	£700			
Air conditioning				●
16" 'Ashera' alloy wheels (set of four) with black centre caps <sup>9</sup>				●
<b>LED Signature</b>	£300	●	●	●
Daytime-running LEDs, front fog lights and grille chrome surrounds and chrome insert on rear number plate moulding				
Air conditioning	£550	●	●	
Dark tinted rear windows		●	●	●
Space saver spare wheel	£75	£75	£75	●
<b>'Zebra' Spirit</b> – 'Zebra' roof stickers and carpet mats <sup>11</sup>	£400	£400	£400	£400
<b>'Pearl' Spirit</b> – 'Pearl' roof stickers and carpet mats <sup>12</sup>	£400	£400	£400	£400
<b>'Urban Tribe' Spirit</b> – 'Urban Tribe' roof stickers and carpet mats <sup>13</sup>	£400	£400	£400	£400
<b>'Plane' Spirit</b> – 'Plane' roof stickers and carpet mats <sup>14</sup>	£400	£400	£400	£400
<b>'Co-Design' Spirit</b> – 'Co-Design' roof stickers and carpet mats <sup>15</sup>	£400	£400	£400	£400
<b>'Flower' Spirit</b> – 'Flower' roof stickers and carpet mats	£400	£400	£400	£400
<b>'Graphic Art' Spirit</b> – 'Graphic Art' roof stickers and carpet mats <sup>16</sup>	£400	£400	£400	£400

	DSign	DStyle	DSport
<b>BODY COLOUR SUMMARY</b>			
Polar White	●	●	●
Shark Grey (metallic)	£495	£495	£495
Arctic Steel (metallic)	£495	£495	£495
Ruby Red (metallic)	£495	£495	£495
Perla Nera Black (metallic)	£495	£495	£495
Hickory Brown (metallic)	£495	£495	£495
Ink Blue (metallic)	£495	£495	£495
Whisper Purple (metallic)		£495	£495
Sport Yellow	£495	£495	£495



# CITROËN DS3 CABRIO

## BLACK 'TOUCH'

	DSign	DStyle	DSport
<b>'TOUCH' SUMMARY</b>			
Roof colour painted door mirrors	●	●	●
Chrome door mirrors	£100	£100	£100
16" 'Nuclear' wheel covers (set of four) with black centre caps	●		
16" 'Ashera' Original alloy wheels (set of four) with black centre caps <sup>1</sup>	○	●	
16" White 'Ashera' alloy wheels (set of four) with black centre caps	£500	£100	
16" Black 'Ashera' alloy wheels (set of four) with black centre caps	£500	£100	
16" Infinite Blue 'Ashera' alloy wheels (set of four) with black centre caps			
17" Moondust Grey 'Bellone' alloy wheels (set of four) with black centre caps		£200	◆
17" Black 'Bellone' alloy wheels (set of four) with black centre caps		£300	●
17" White 'Bellone' alloy wheels (set of four) with black centre caps		£300	◆
17" Moondust Grey 'Bellone' alloy wheels (set of four) with black centre caps			
Aluminium effect dashboard with black gear knob cap <sup>2</sup>	●		
Gloss black dashboard with black gear knob cap <sup>2</sup>	£150	●	£150
Carbon fibre effect dashboard with black gear knob cap <sup>2</sup>			●
White dashboard with white gear knob cap <sup>3/4/5</sup>		£150	£150
Infinite Blue dashboard with Infinite Blue gear knob cap			
Moondust Grey dashboard with Moondust Grey gear knob cap <sup>4/5/6</sup>		£150	£150
Mistral 'Sturm' cloth	●		
Mistral 'Rayados' cloth		●	
Mistral 'Akinen' cloth and Mistral Alcantara <sup>7/8</sup>	£600	£450	●
Mistral 'Akinen' cloth and 'Infinite Blue' Alcantara <sup>8</sup>			
Mistral 'Akinen' cloth and 'Brun Chic' Alcantara <sup>8/8</sup>		£450	£450
<b>Black Leather Pack<sup>2</sup></b>	£1,100	£1,100	£850
Leather gear knob			
Black leather sport seats and leather door panels			
<b>Granite Blue Leather Pack<sup>2/9</sup></b>		£1,100	£850
Leather gear knob			
Granite Blue leather sport seats and leather door panels			
<b>Grey/Black Leather Pack<sup>2</sup></b>		£1,100	£850
Leather gear knob			
Grey/Black leather sport seats and leather door panels			
<b>Connect Signature<sup>10/11</sup></b>	£800		●
Air conditioning		●	
Connecting Box (Bluetooth® system with USB socket)		●	
Hi-Fi system audio upgrade		£200	●

	DSign	DStyle	DSport
<b>'TOUCH' SUMMARY</b>			
<b>eMyWay City Signature<sup>4/10</sup></b>	£1,450	£1,200	£1,000
Interior mood lighting			●
Connecting Box (Bluetooth® system with USB socket) and Hi-Fi system			●
Automatic digital air conditioning			●
Automatic illumination of headlamps, automatic rain-sensitive windscreen wipers, electrochromic rear view mirror, front central armrest, electrically heated and folding door mirrors, eMyWay Signature and gloss black dashboard			
<b>City Signature</b>	£950	£500	£300
Interior mood lighting		●	●
Automatic digital air conditioning		●	●
Automatic illumination of headlamps, automatic rain-sensitive windscreen wipers, electrochromic rear view mirror, front central armrest and electrically heated and folding door mirrors			
<b>Intro Signature<sup>11</sup></b>	£700	●	
Air conditioning		●	
16" 'Ashera' alloy wheels (set of four) with black centre caps		●	
Daytime-running LEDs	£300	●	●
Air conditioning		●	
Dark tinted rear windows	●	●	●
Space saver spare wheel	£75	£75	●
Rear Parking Sensors	●	●	●

- Standard equipment
- ◆ No cost option
- Optional factory fitted equipment
- Not available on this colour 'Touch' models but might be available with other colours.

All prices shown are the Manufacturer's recommended retail prices and include V.A.T.

- 1 Available only as part of optional Intro Signature.
- 2 When optional Leather Pack is ordered, leather gear knob cap is present on manual models.
- 3 Only available with Polar White body colour.
- 4 eMyWay Signature and white/Moondust Grey dashboard are not compatible.
- 5 Coloured gear knob cap not available on automatic models.
- 6 Not available with Hickory Brown, Sport Yellow, Shark Grey, Arctic Steel or Ruby Red body colours.
- 7 When optional Mistral 'Akinen' cloth and Mistral Alcantara<sup>®</sup> is ordered, height-adjustable front passenger seat and aluminium pedals are present.
- 8 Not available with Belle Ile Blue, Whisper Purple, Sport Red, Sport Yellow or Hickory Brown body colours. Not available with Moondust Grey Monogramme Signature or Infinite Blue two tone configurations.
- 9 Granite Blue leather not available with Belle Ile Blue, Whisper Purple, Sport Red, Sport Yellow, Hickory Brown or Ruby Red body colours and Moondust Grey roof configurations.
- 10 Mobile phone compatibility can vary by phone manufacturer. Please consult your Dealer for further compatibility information.
- 11 On DSign models, Connect and Intro Signatures are not compatible.

# CITROËN DS3 CABRIO

## INFINITE BLUE 'TOUCH'



	DSign	DStyle	DSport
<b>BODY COLOUR SUMMARY</b>			
Polar White	£150	£150	£150
Shark Grey (metallic)	£645	£645	£645
Arctic Steel (metallic)	£645	£645	£645
Perla Nera Black (metallic)	£645	£645	£645

- Standard equipment
- ◆ No cost option
- Optional factory fitted equipment

○ Not available on this colour 'Touch' models but might be available with other colours.

All prices shown are the Manufacturer's recommended retail prices and include V.A.T.

<sup>1</sup> Available only as part of optional Intro Signature.

<sup>2</sup> When optional Leather Pack is ordered, leather gear knob cap is present on manual models.

<sup>3</sup> Only available with Polar White body colour.

<sup>4</sup> eMyWay Signature and white or Infinite Blue dashboards are not compatible.

<sup>5</sup> Coloured gear knob cap not available on automatic models.

<sup>6</sup> When optional Mistral 'Akinen' cloth and Mistral Alcantara® is ordered, heightadjustable front passenger seat and aluminium pedals are present.

<sup>7</sup> Granite Blue leather not available with Belle Ile Blue, Whisper Purple, Sport Red, Sport Yellow, Hickory Brown or Ruby Red body colours and Moondust Grey roof configuration.

<sup>8</sup> Mobile phone compatibility can vary by phone manufacturer. Please consult your Dealer for further compatibility information.

<sup>9</sup> On DSign models, Connect and Intro Signatures are not compatible.

	DSign	DStyle	DSport
<b>'TOUCH' SUMMARY</b>			
Roof colour painted door mirrors	●	●	●
Chrome door mirrors	£100	£100	£100
16" 'Nuclear' wheel covers (set of four) with Infinite Blue centre caps	●		
16" 'Ashera' Original alloy wheels (set of four) with Infinite Blue centre caps <sup>1</sup>	○	●	
16" White 'Ashera' alloy wheels (set of four) with Infinite Blue centre caps	£500	£100	
16" Black 'Ashera' alloy wheels (set of four) with Infinite Blue centre caps	£500	£100	
16" Infinite Blue 'Ashera' alloy wheels (set of four) with Infinite Blue centre caps	£500	£100	
17" Moondust Grey 'Bellone' alloy wheels (set of four) with Infinite Blue centre caps		£200	◆
17" Black 'Bellone' alloy wheels (set of four) with Infinite Blue centre caps		£300	●
17" White 'Bellone' alloy wheels (set of four) with Infinite Blue centre caps		£300	◆
17" Moondust Grey 'Bellone' alloy wheels (set of four) with black centre caps			
Aluminium effect dashboard with black gear knob cap <sup>2</sup>	●		
Gloss black dashboard with black gear knob cap <sup>2</sup>	£150	●	£150
Carbon fibre effect dashboard with black gear knob cap <sup>2</sup>	£150	£150	●
White dashboard with white gear knob cap <sup>3/4/5</sup>	£150	£150	£150
Infinite Blue dashboard with Infinite Blue gear knob cap <sup>4</sup>		£150	£150
Moondust Grey dashboard with Moondust Grey gear knob cap			
Mistral 'Sturm' cloth	●		
Mistral 'Rayados' cloth		●	
Mistral 'Akinen' cloth and Mistral Alcantara® <sup>6</sup>	£600	£450	●
Mistral 'Akinen' cloth and 'Infinite Blue' Alcantara®		£450	£450
Mistral 'Akinen' cloth and 'Brun Chic' Alcantara®			
<b>Black Leather Pack<sup>2</sup></b>	£1,100	£1,100	£850
Leather gear knob			
Black leather sport seats and leather door panels			
<b>Granite Blue Leather Pack<sup>2/7</sup></b>		£1,100	£850
Leather gear knob			
Granite Blue leather sport seats and leather door panels			
<b>Grey/Black Leather Pack<sup>2</sup></b>		£1,100	£850
Leather gear knob			
Grey/black leather sport seats and leather door panels			
<b>Connect Signature<sup>8/9</sup></b>	£800		●
Air conditioning		●	
Connecting Box (Bluetooth® system with USB socket)		●	
Hi-Fi system audio upgrade		£200	●

	DSign	DStyle	DSport
<b>'TOUCH' SUMMARY</b>			
<b>eMyWay City Signature<sup>4/8</sup></b>	£1,450	£1,200	£1,000
Interior mood lighting		●	●
Connecting Box (Bluetooth® system with USB socket) and Hi-Fi system			●
Automatic digital air conditioning			●
Automatic illumination of headlamps, automatic rain-sensitive windscreen wipers, electrochromic rear view mirror, front central armrest, electrically heated and folding door mirrors, eMyWay Signature and gloss black dashboard			
<b>City Signature</b>	£950	£500	£300
Interior mood lighting		●	●
Automatic digital air conditioning			●
Automatic illumination of headlamps, automatic rain-sensitive windscreen wipers, electrochromic rear view mirror, front central armrest and electrically heated and folding door mirrors			
<b>Intro Signature<sup>9</sup></b>	£700	●	
Air conditioning		●	
16" 'Ashera' alloy wheels (set of four) with Infinite Blue centre caps		●	
Daytime-running LEDs	£300	●	●
Air conditioning		●	
Dark tinted rear windows	●	●	●
Space saver spare wheel	£75	£75	●
Rear Parking Sensors	●	●	●

	DSport
<b>BODY COLOUR SUMMARY</b>	
Polar White	£350
Perla Nera Black (metallic)	£845
Ink Blue (metallic)	£845
Whisper Purple (metallic)	£645
Ruby Red (metallic)	£845



# CITROËN DS3 CABRIO

MOONDUST GREY  
MONOGRAMME  
'SIGNATURE'

	DSport
<b>'TOUCH' SUMMARY</b>	
Moondust Grey painted door mirrors	•
Chrome door mirrors	£100
16" 'Nuclear' wheel covers (set of four) with black centre caps	
16" 'Ashera' Original alloy wheels (set of four) with black centre caps	
16" White 'Ashera' alloy wheels (set of four) with black centre caps	
16" Black 'Ashera' alloy wheels (set of four) with black centre caps	
16" Infinite Blue 'Ashera' alloy wheels (set of four) with Infinite Blue centre caps	
17" Black 'Bellone' alloy wheels (set of four) with black centre caps	
17" White 'Bellone' alloy wheels (set of four) with black centre caps	
17" Moondust Grey 'Bellone' alloy wheels (set of four) with black centre caps	•
Aluminium effect dashboard with black gear knob cap	
Gloss black dashboard with black gear knob cap	
Carbon fibre effect dashboard with black gear knob cap	
White dashboard with white gear knob cap	
Infinite Blue dashboard with Infinite Blue gear knob cap	
Moondust Grey dashboard with Moondust Grey gear knob cap <sup>1/2/3</sup>	•
Mistral 'Sturm' cloth	
Mistral 'Rayados' cloth	
Mistral 'Akinen' cloth and Mistral Alcantara <sup>®4</sup>	•
Mistral 'Akinen' cloth and 'Infinite Blue' Alcantara <sup>®</sup>	
<b>Black Leather Pack'</b>	£850
Leather gear knob	
Black leather sport seats and leather door panels	
<b>Grey/Black Leather Pack'</b>	£850
Leather gear knob	
Grey/Black leather sport seats and leather door panels	
<b>Connect Signature<sup>5</sup></b>	•
Air conditioning	
Connecting Box (Bluetooth <sup>®</sup> system with USB socket)	
Hi-Fi system audio upgrade	•

	DSport
<b>'TOUCH' SUMMARY</b>	
<b>eMyWay City Signature<sup>5</sup></b>	£1,000
Interior mood lighting	•
Connecting Box (Bluetooth <sup>®</sup> system with USB socket) and Hi-Fi system	•
Automatic digital air conditioning	•
Automatic illumination of headlamps, automatic rain-sensitive windscreen wipers, electrochrome rear view mirror, front central armrest, electrically heated and folding door mirrors, eMyWay Signature and gloss black dashboard	
<b>City Signature</b>	£300
Interior mood lighting	•
Automatic digital air conditioning	•
Automatic illumination of headlamps, automatic rain-sensitive windscreen wipers, electrochrome rear view mirror, front central armrest and electrically heated and folding door mirrors	
<b>Intro Signature</b>	
Air conditioning	•
16" 'Ashera' alloy wheels (set of four) with black centre caps	
<b>LED Signature</b>	•
Daytime-running LEDs, front fog lights and grille chrome surrounds and chrome insert on rear number plate moulding	
Air conditioning	•
Dark tinted rear windows	•
Space saver spare wheel	•
Rear Parking Sensors	•

- Standard equipment
- ◆ No cost option
- Optional factory fitted equipment
- Not available on this colour 'Touch' models but might be available with other colours.

All prices shown are the Manufacturer's recommended retail prices and include V.A.T.

- <sup>1</sup> When optional Leather Pack is ordered, leather gear knob cap is present on manual models.
- <sup>2</sup> Coloured gear knob cap not available on automatic models.
- <sup>3</sup> eMyWay Signature and white or Moondust Grey dashboards are not compatible.
- <sup>4</sup> When optional Mistral 'Akinen' cloth and Mistral Alcantara<sup>®</sup> is ordered, height-adjustable front passenger seat and aluminium pedals are present.
- <sup>5</sup> Mobile phone compatibility can vary by phone manufacturer. Please consult your Dealer for further compatibility information.



This brochure is made from paper from a well-managed forest. Citroën support responsible use of forest resources.

Please don't throw me away, give me to a friend or recycle me.

NOTE: Every endeavour has been made to ensure that the information and details contained in this brochure were accurate at the time of going to press March 2014. However the company reserves the right, whilst preserving the essential characteristics of the models described, to introduce at any time modifications, changes of details or equipment. Every effort will be made to bring this brochure up to date, but in order to avoid any misunderstandings please consult your Dealer. For full details of Citroën Care for Car and Driver, please see the full manufacturer's price list. The Citroën Website contains full information on all Citroën products and offers available in the UK, together with details of our environmental and recycling policies. The site address is: [www.citroen.co.uk](http://www.citroen.co.uk) or you can contact Citroën directly via [cuk\\_contactcentre@citroen.com](mailto:cuk_contactcentre@citroen.com)

**CITROËN** prefers **TOTAL**

CITROËN UK Ltd. Pinley House, 2 Sunbeam Way, Coventry CV3 1ND.

[www.citroen.co.uk](http://www.citroen.co.uk)

Designed and produced by Acuity

[www.weareacuity.com](http://www.weareacuity.com)

K12303 MARCH 2014

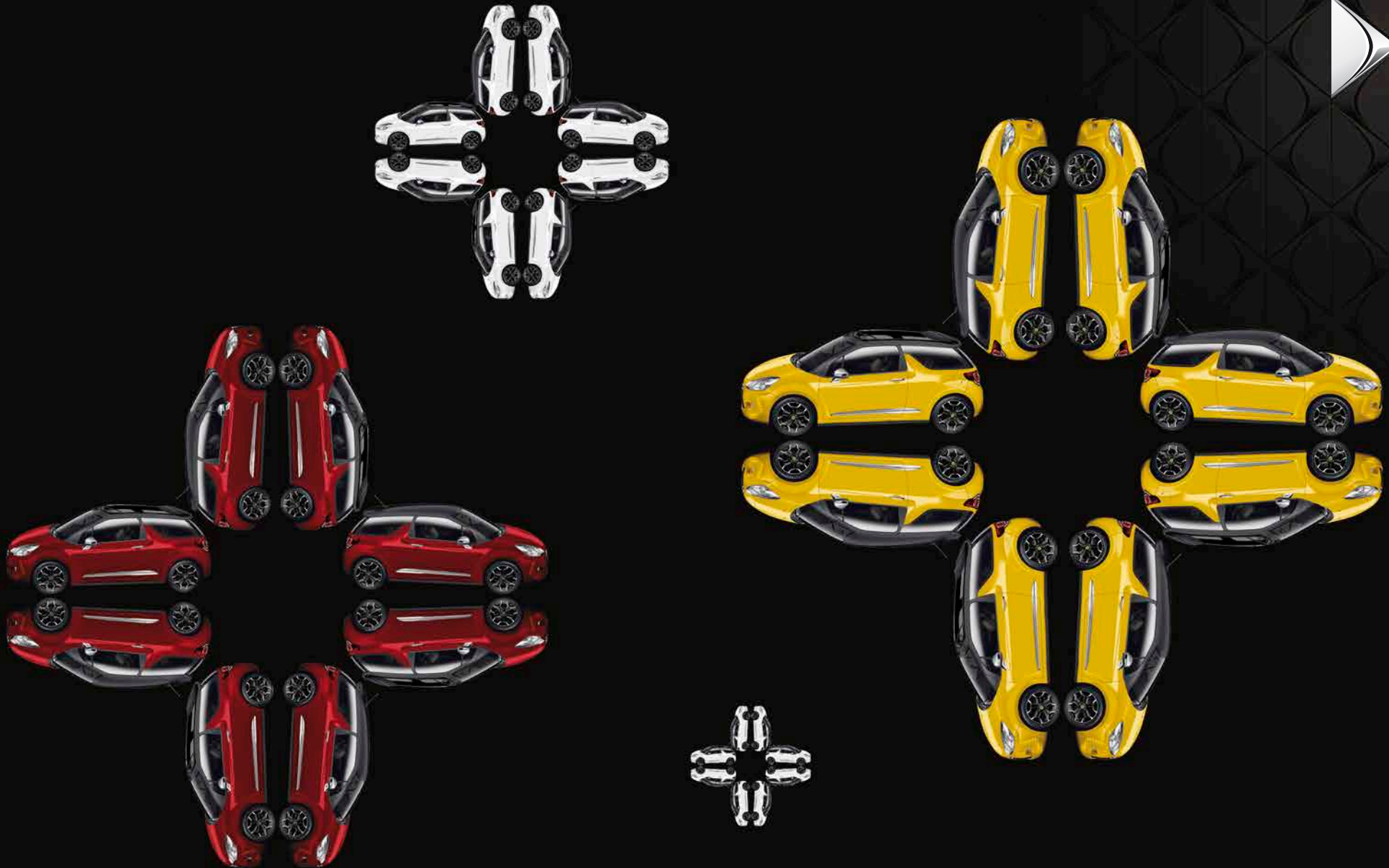
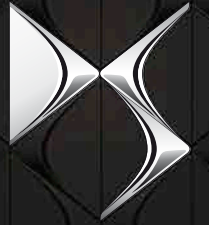

CITROËN DS3 PLUS PACK





Somewhere between design inspiration and practical reality, the spark of originality is often compromised. Not DS line, as Citroën DS3 makes vividly clear. Here, every unique flourish, fresh innovation, bold curve and sensual finish reflects the inspiration of its creators.

This is why it looks like no other car; why an audacious 'shark fin' form rises dramatically from the waistline; why the roofline appears to float above the glass house and body, and why you can walk around Citroën DS3 again and again spotting fresh, pleasing details. Here is a unique distillation of what makes Citroën so different.

CITROËN

**ANTI RETRO.** EACH ELEMENT AND EVERY ANGLE OF CITROËN DS3 AND DS3 CABRIO IS FRESH, ORIGINAL AND INNOVATIVE; ADVANCED AND RADICALLY DIFFERENT FROM OTHER CARS, IT IS A CLEAR EXPRESSION AND CELEBRATION OF CRÉATIVE TECHNOLOGIE.

BUT CITROËN DS3 AND DS3 CABRIO ARE ALSO ABOUT YOU, BECAUSE THROUGH THEIR HUGE RANGE OF PERSONALISATION OPTIONS, THEY ALLOW YOU TO FINE TUNE A CAR THAT REFLECTS YOUR CHARACTER AND TASTE MORE CLEARLY AND STYLISHLY THAN EVER. CITROËN DS3 AND DS3 CABRIO TAKE FREEDOM OF EXPRESSION TO THE NEXT LEVEL. YOU WANT MORE? INTRODUCING CITROËN DS3 PLUS PACK WITH MORE OF WHAT MAKES THEM UNIQUE.







## PLUS VIBRANCY. PLUS TECHNOLOGY. PLUS PRESENCE. THE RADICAL, ELEGANT CITROËN DS3 AND DS3 CABRIO ARE NOW AVAILABLE WITH EVEN MORE.

ADD DS3 PLUS PACK TO DSIGN AND ENHANCE ITS STYLE AND COMFORT WITH THE 16" 'ASHERA' ALLOY WHEELS AND AIR CONDITIONING. ADDING CITROËN DS3 PLUS PACK OR DS3 CABRIO PLUS PACK TO DSTYLE AND DSPORT MEANS THESE HIGHLY SPECIFIED MODELS FEATURE 17" BLACK ALLOY WHEELS AND COME WITH CITY SIGNATURE – THIS INCLUDES REAR PARKING SENSORS (STANDARD ON CABRIO MODELS), AUTOMATIC WIPERS AND HEADLIGHTS, AUTOMATIC DIGITAL AIR CONDITIONING, AN ELECTROCHROME REAR VIEW MIRROR, FRONT CENTRAL ARMREST, ELECTRICALLY HEATED AND FOLDING DOOR MIRRORS AND INTERIOR MOOD LIGHTING.

DSport models with Citroën DS3 Plus Pack also have Black leather interior as standard. Plus, to highlight the stunning body colours they are finished with chrome door mirror covers. This enhances a specification that already comprises a Bluetooth® system with USB socket, Hi-Fi system and anti-theft alarm, leather trimmed steering wheel with chrome inserts and dark tinted rear windows. The safety technology is just as comprehensive and includes ABS with Electronic Brakeforce Distribution (EBD), Emergency Braking Assistance (EBA), and an Electronic Stability Control (ESC). Just one question remains: what body and roof combination will you choose?

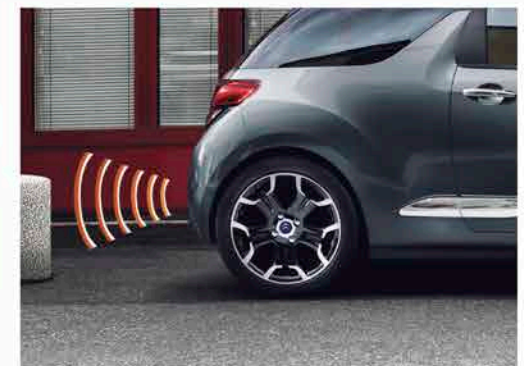

# DSIGN PLUS PACK ENHANCED BASE

## > CITROËN DS3 DSIGN SPECIFICATION INCLUDES:

- 16" 'Nuclear' wheel covers (set of four)
- Electronic Stability Control (ESC)
- Electrically adjustable door mirrors
- Chrome side rubbing strips
- Front fog lights
- Chrome door handles
- Aluminium effect dashboard
- 'Soft-touch' effect upper dashboard
- Black centre console
- Leather steering wheel with aluminium effect inserts
- Cruise control with speed limiter
- Sport suspension
- Variable power assisted steering
- Gear Efficiency Indicator (GEI)
- Electronic Stability Control (ESC)
- Rear 3D effect LED lights

## > ADDITIONAL SPECIFICATION WITH THE DSIGN PLUS PACK INCLUDES:

- 16" 'Ashera' alloy wheels (set of four)
- Air conditioning



BODY COLOUR SUMMARY	WHITE	INFINITE BLUE	BLACK
Polar White	•	•	•
Shark Grey (metallic)	•	•	•
Arctic Steel (metallic)	•	•	•
Ruby Red (metallic)	•	•	•
Perla Nera Black (metallic)	•	•	•
Hickory Brown (metallic)	•	•	•
Ink Blue (metallic)	•	•	•
Belle Ile Blue (metallic)	•	•	•
Sport Red	•	•	•
Sport Yellow	•	•	•

## BODY COLOURS



Polar White Shark Grey (M)



Arctic Steel (M) Ruby Red (M)

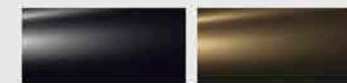

Perla Nera Black (M) Hickory Brown (M)

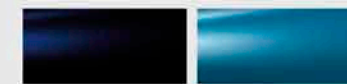

Ink Blue (M) Belle Ile Blue (M)



Sport Red Sport Yellow

## ROOF COLOUR



White Black



Infinite Blue

## TRIMS



Mistral 'Sturm' cloth

## 16" 'ASHERA' ALLOY WHEELS

Set of four

Tyres: 195/55 R16



(M) Metallic

BODY COLOURS

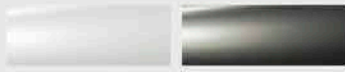

Polar White Shark Grey (M)



Arctic Steel (M) Ruby Red (M)

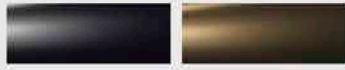

Perla Nera Black (M) Hickory Brown (M)

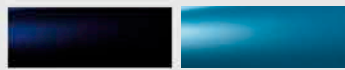

Ink Blue (M) Belle Ile Blue (M)

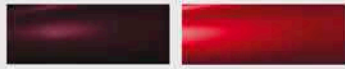

Whisper Purple (M) Sport Red



Sport Yellow

ROOF COLOUR

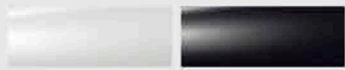

White Black

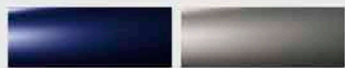

Infinite Blue Moondust Grey

TRIMS



Mistral 'Rayados' cloth

17" 'BELLONE' BLACK ALLOY WHEELS

Set of four

Tyres: 205/45 R17



(M) Metallic

# DSTYLE PLUS PACK URBAN REGENERATION

> CITROËN DS3 DSTYLE SPECIFICATION INCLUDES:

- 16" 'Ashera' alloy wheels
- Signature daytime-running LEDs
- Front fog lights
- Chrome front grille and fog light surrounds with chrome insert on rear number plate moulding
- Leather steering wheel
- Chrome side rubbing strips
- **Connecting box** – Bluetooth® system with USB socket
- Dark tinted rear windows
- Scented air freshener
- Gear Efficiency Indicator (GEI) (Excludes automatic versions)
- Cruise control with speed limiter
- Sport suspension
- Front electric windows with 'one-touch' operation on driver's side
- Air conditioning
- Leather handbrake
- Gloss black dashboard
- Chrome gear surround

> ADDITIONAL SPECIFICATION WITH THE DSTYLE PLUS PACK INCLUDES:

- **City Signature** – interior mood lighting, automatic digital air conditioning, automatic rain-sensitive windscreen wipers, automatic illumination of headlamps and electrochrome rear view mirror, rear parking sensors, front central armrest, electrically heated and folding door mirrors
- 17" 'Bellone' Black alloy wheels (set of four)
- Contrasting body/roof colour



BODY COLOUR SUMMARY

Polar White	•	•	•	•
Shark Grey (metallic)	•	•	•	•
Arctic Steel (metallic)	•	•	•	•
Ruby Red (metallic)	•	•	•	•
Perla Nera Black (metallic)	•	•	•	•
Hickory Brown (metallic)	•	•	•	•
Ink Blue (metallic)	•	•	•	•
Belle Ile Blue (metallic)	•	•	•	•
Whisper Purple (metallic)	•	•	•	•
Sport Red	•	•	•	•
Sport Yellow	•	•	•	•

WHITE

INFINITE BLUE

MOONDUST GREY

BLACK

# CABRIO DSTYLE PLUS PACK

## JUST ADD BRILLIANCE

### > CITROËN DS3 CABRIO DSTYLE SPECIFICATION INCLUDES:

- 16" 'Ashera' alloy wheels
- Signature daytime-running LEDs
- Front fog lights
- Chrome front grille and fog light surrounds with chrome insert on rear number plate moulding
- Rear parking sensors
- Leather steering wheel
- Chrome side rubbing strips
- **Connecting box** – Bluetooth® system with USB socket
- Air conditioning
- Dark tinted rear windows
- Scented air freshener
- Gear Efficiency Indicator (GEI) (Excludes automatic versions)
- Cruise control with speed limiter
- Sport suspension
- Front electric windows with 'one-touch' operation on driver's side
- Leather handbrake
- Gloss black dashboard
- Chrome gear surround

### > ADDITIONAL SPECIFICATION WITH THE CABRIO DSTYLE PLUS PACK INCLUDES:

- **City Signature** – interior mood lighting, automatic digital air conditioning, automatic rain-sensitive windscreen wipers, automatic illumination of headlamps and electrochrome rear view mirror, front central armrest, electrically heated and folding door mirrors
- 17" 'Bellone' Black alloy wheels (set of four)



BODY COLOUR SUMMARY	BLACK	INFINITE BLUE
Polar White	•	•
Shark Grey (metallic)	•	•
Arctic Steel (metallic)	•	•
Ruby Red (metallic)	•	•
Perla Nera Black (metallic)	•	•
Hickory Brown (metallic)	•	•
Whisper Purple (metallic)	•	•
Ink Blue (metallic)	•	•
Sport Yellow	•	•

### BODY COLOURS



Polar White

Shark Grey (M)



Arctic Steel (M)

Ruby Red (M)

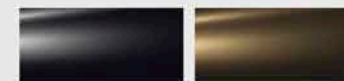

Perla Nera Black (M)

Hickory Brown (M)

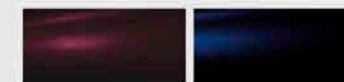

Whisper Purple (M)

Ink Blue (M)



Sport Yellow

### ROOF COLOUR

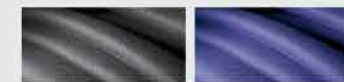

Black

Infinite Blue

### TRIMS



Mistral 'Rayados' cloth

### 17" 'BELLONE' BLACK ALLOY WHEELS

Set of four

Tyres: 205/45 R17



(M) Metallic

BODY COLOURS

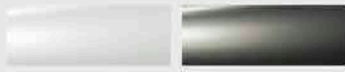

Polar White Shark Grey (M)



Arctic Steel (M) Ruby Red (M)

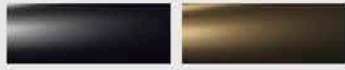

Perla Nera Black (M) Hickory Brown (M)



Ink Blue (M) Belle Ile Blue (M)

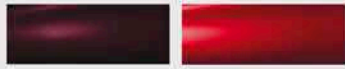

Whisper Purple (M) Sport Red



Sport Yellow

ROOF COLOUR

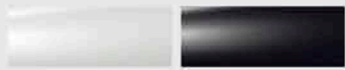

White Black

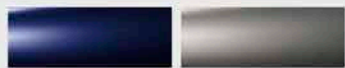

Infinite Blue Moondust Grey

TRIMS



Black leather pack

17" 'BELLONE' BLACK ALLOY WHEELS

Set of four  
Tyres: 205/45 R17



(M) Metallic

# DSPORT PLUS PACK HIGHLY CONNECTED

> CITROËN DS3 DSPORT SPECIFICATION INCLUDES:

- **Connect Signature** – Connecting Box (Bluetooth® system with USB socket) and Hi-Fi system
- Rear spoiler with an integrated third brake light
- Automatic digital air conditioning
- 17" 'Bellone' Black alloy wheels (set of four)
- Contrasting body/roof colour
- Anti-theft alarm
- Double chrome exhaust pipe
- Front and rear carpet mats
- Aluminium drilled pedals
- Carbon fibre effect dashboard
- High quality leather steering wheel with chrome inserts
- Height adjustable front passenger's seat

> ADDITIONAL SPECIFICATION WITH THE DSPORT PLUS PACK INCLUDES:

- **City Signature** – interior mood lighting, automatic rain-sensitive windscreen wipers, automatic illumination of headlamps and electrochrome rear view mirror, rear parking sensors, front central armrest, electrically heated and folding door mirrors
- Black leather pack
- Chrome door mirrors



BODY COLOUR SUMMARY

Polar White	•	•	•	•
Shark Grey (metallic)	•	•	•	•
Arctic Steel (metallic)	•	•	•	•
Ruby Red (metallic)	•	•	•	•
Perla Nera Black (metallic)	•	•	•	•
Hickory Brown (metallic)	•	•	•	•
Ink Blue (metallic)	•	•	•	•
Belle Ile Blue (metallic)	•	•	•	•
Whisper Purple (metallic)	•	•	•	•
Sport Red	•	•	•	•
Sport Yellow	•	•	•	•

WHITE

INFINITE BLUE

MOONDUST GREY

BLACK

# CABRIO DSPORT PLUS PACK

## NOTHING COMES CLOSE

### > CITROËN DS3 CABRIO DSPORT SPECIFICATION INCLUDES:

- 17" 'Bellone' Black alloy wheels
- **Connect Signature** – Connecting Box (Bluetooth® system with USB socket) and Hi-Fi system
- Rear parking sensors
- Automatic digital air conditioning
- Rear sports deflector and spoiler with an integrated third brake light
- Anti-theft alarm
- Double chrome exhaust pipe
- Front and rear carpet mats
- Aluminium drilled pedals
- Carbon fibre effect dashboard
- High quality leather steering wheel with chrome inserts
- Height adjustable front passenger seat

### > ADDITIONAL SPECIFICATION WITH THE CABRIO DSPORT PLUS PACK INCLUDES:

- **City Signature** – interior mood lighting, automatic rain-sensitive wipers, automatic illumination of headlamps and electrochrome rear view mirror, front central armrest, electrically heated and folding door mirrors
- Black leather pack
- Chrome door mirrors



BODY COLOUR SUMMARY	BLACK	INFINITE BLUE	MOONDUST MONOGRAMME
Polar White	•	•	•
Shark Grey (metallic)	•	•	•
Arctic Steel (metallic)	•	•	•
Ruby Red (metallic)	•	•	•
Perla Nera Black (metallic)	•	•	•
Hickory Brown (metallic)	•	•	•
Whisper Purple (metallic)	•	•	•
Ink Blue (metallic)	•	•	•
Sport Yellow	•	•	•

### BODY COLOURS



Polar White Shark Grey (M)



Arctic Steel (M) Ruby Red (M)

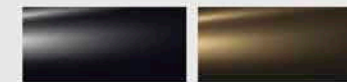

Perla Nera Black (M) Hickory Brown (M)

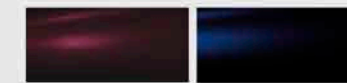

Whisper Purple (M) Ink Blue (M)



Sport Yellow

### ROOF COLOUR

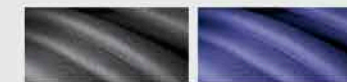

Black Infinite Blue



Moondust Monogramme Signature

### TRIMS



Black leather pack

### 17" 'BELLONE' BLACK ALLOY WHEELS

Set of four

Tyres: 205/45 R17



(M) Metallic

# EQUIPMENT SPECIFICATION

	DSign Plus	DStyle Plus	DSport Plus	Cabrio DStyle Plus	Cabrio DSport Plus
<b>SAFETY &amp; SECURITY</b>					
ABS with Electronic Brakeforce Distribution (EBD) and Emergency Braking Assistance (EBA)	●	●	●	●	●
Electronic Stability Control (ESC)	●	●	●	●	●
Driver's airbag	●	●	●	●	●
Front passenger's airbag with cut-off device	●	●	●	●	●
Front lateral and curtain airbags	●	●	●	●	●
High-frequency remote control central locking with deadlocks	●	●	●	●	●
Automatic door and boot locking (when car in motion)	●	●	●	●	●
Cruise control with speed limiter	●	●	●	●	●
Anti-theft alarm			●	●	●
Citroën eTouch Emergency & Assistance System			●	●	●
<b>LIGHTING &amp; VISIBILITY</b>					
Electrically adjustable, heated and folding door mirrors	●	●	●	●	●
3D LED rear lights	●	●	●	●	●
LED daytime-running lights		●	●	●	●
Automatic rain-sensitive windscreen wipers, automatic illumination of headlamps & electrochrome rear view mirror		●	●	●	●
Front fog lights	●	●	●	●	●
Interior mood lighting		●	●	●	●
<b>DRIVER INFORMATION</b>					
Gear Efficiency Indicator (GEI)	●	●	●	●	●
Puncture repair kit	●	●		●	
Space saver spare wheel		○	●	○	●
<b>COMFORT &amp; CONVENIENCE</b>					
Sport suspension	●	●	●	●	●
Height and reach adjustable steering wheel	●	●	●	●	●
Front electric windows with 'one-touch' operation on driver's side	●	●	●	●	●
Rear parking sensors		●	●	●	●
Air conditioning	●				
Automatic digital air conditioning		●	●	●	●
<b>SEATING</b>					
Rear 1/3-2/3 split/folding seats	●	●	●	●	●
Height-adjustable driver's seat	●	●	●	●	●
Height-adjustable front passenger's seat			●		●

● If roof colour is black or Infinite Blue.

○ Optional factory fitted equipment

<sup>1</sup> Mobile phone compatibility can vary by phone manufacturer. Please consult your Dealer for further compatibility information.

	DSign Plus	DStyle Plus	DSport Plus	Cabrio DStyle Plus	Cabrio DSport Plus
<b>STYLE</b>					
<b>EXTERIOR</b>					
16" 'Ashera' alloy wheels (set of four)	●				
17" 'Bellone' Black alloy wheels (set of four)		●	●	●	●
Dark tinted rear windows		●	●	●	●
Chrome door handles	●	●	●	●	●
Chrome front fog light and grille surrounds		●	●	●	●
Chrome insert on rear number plate moulding		●	●	●	●
Chrome side rubbing strips	●	●	●	●	●
Chrome door mirrors			●	●	●
Double chrome exhaust pipe			●	●	●
Rear spoiler with an integrated third brake light			●	●	●
<b>INTERIOR</b>					
Mistral 'Sturm' cloth	●				
Mistral 'Rayados' cloth		●		●	
Black leather pack			●		●
Leather steering wheel with aluminium effect inserts	●				
Leather steering wheel with chrome inserts		●		●	
High quality leather steering wheel with chrome inserts			●		●
Black centre console	●				
Gloss black painted centre console		●	●	●	●
Chrome door sill protector	●	●	●	●	●
'Soft-touch' effect upper dashboard	●	●	●	●	●
Aluminium effect dashboard	●				
Gloss black dashboard		●		●	○
Carbon fibre effect dashboard			●		●
Aluminium drilled pedals			●		●
<b>IN-CAR ENTERTAINMENT</b>					
RDS stereo radio/MP3 compatible CD player with steering mounted controls, auxiliary socket & 6 speakers		●		●	
Connect Signature – Connecting Box (Bluetooth® system with USB socket) and Hi-Fi system			● <sup>1</sup>		● <sup>1</sup>
Connecting Box – Bluetooth® system with USB socket		● <sup>1</sup>		● <sup>1</sup>	
<b>OPTION SUMMARY</b>					
Contrasting body/roof colour	○	●	●	●	●
Metallic paint	○	○	○	○	○
Sport Red paint	○	○	○		
Sport Yellow paint	○	○	○	○	○
17" 'Bellone' Original or White alloy wheels (set of four)		○	○	○	○
Hi-Fi system upgrade		○		○	
eMyWay – colour satellite navigation, live traffic information, European mapping			○		○
Infinite Blue 'Touch'				○	○
Moondust Grey Monogramme Signature – Moondust Monogramme roof, 17" Moondust Grey 'Bellone' alloy wheels and Moondust Grey dashboard kit					○

# TECHNICAL SPECIFICATION

	PETROL MODELS						DIESEL MODELS			
	DSign Plus VTi 82 manual	DStyle Plus VTi 120 manual	Cabrio DStyle Plus VTi 120 manual	DSport Plus THP 155 6-speed manual	Cabrio DSport Plus THP 155 6-speed manual	DStyle Plus VTi 120 automatic	Cabrio DStyle Plus VTi 120 automatic	DStyle Plus e-HDi 90 Airdream manual	Cabrio DStyle Plus e-HDi 90 Airdream manual	DSport Plus e-HDi 115 Airdream 6-speed manual
<b>ENGINE</b>										
Capacity (cc)	1199	1598	1598	1598	1598	1598	1598	1560	1560	1560
Cylinders	3 in line	4 in line	4 in line	4 in line	4 in line	4 in line	4 in line	4 in line	4 in line	4 in line
Max power CEE (kW/rpm)	60/5750	88/6000	115/6000	115/6000	88/6000	88/6000	88/6000	68/4000	68/4000	84/3600
Max torque CEE (Nm/rpm)	118/2750	160/4200	240/1400	240/1400	160/4200	160/4200	160/4250	230/1750	230/1750	270/1750
Fuel system	Multi-point electronic fuel injection	Multi-point electronic fuel injection	Multi-point electronic turbocharged fuel injection	Multi-point electronic turbocharged fuel injection	Multi-point electronic fuel injection	Multi-point electronic fuel injection	Multi-point electronic fuel injection	High pressure direct diesel injection		
Euro status	Euro 5	Euro 5	Euro 5	Euro 5	Euro 5	Euro 5	Euro 5	Euro 5	Euro 5	Euro 5
<b>TRANSMISSION</b>	Five speed manual	Five speed manual	Five speed manual	Six speed manual	Six speed manual	Four speed automatic	Four speed automatic	Five speed manual	Five speed manual	Six speed manual
Clutch type	Dry single plate	Dry single plate	Dry single plate	Dry single plate	Dry single plate	n/a	n/a	Dry single plate		
<b>PERFORMANCE</b> (All figures driver alone)										
Max speed (mph)	108	118	118	130	132	118	118	113	113	118
0-62mph (secs)	14.2	9.9	9.9	7.3	8.2	10.9	12.2	12.5	12.5	9.7
Standing 1000m (secs)	35.4	31.4	31.4	28.2	29.2	32.4	32.4	34.2	34.2	31.4
<b>ECONOMY Litres/100km (mpg)</b> (Official Government test fuel consumption figures)										
Urban cycle	5.5 (51.4)	7.5 (37.7)	7.5 (37.7)	7.9 (35.8)	8.0 (35.3)	9.3 (30.4)	9.7 (29.1)	4.3 (65.7)	4.3 (65.7)	4.6 (61.4)
Extra urban	3.9 (72.4)	4.5 (62.8)	4.5 (62.8)	4.5 (62.8)	4.8 (58.9)	4.9 (57.6)	4.9 (57.6)	3.3 (85.6)	3.3 (85.6)	3.4 (83.1)
Combined	4.5 (62.8)	5.7 (49.6)	5.7 (49.6)	5.8 (48.7)	5.9 (47.9)	6.5 (43.5)	6.7 (42.2)	3.6 (78.5)	3.6 (78.5)	3.8 (74.4)
<b>CO<sub>2</sub> EMISSIONS (g/km)</b>	104	132	132	135	137	150	154	95	95	99
<b>STEERING</b>	Variable power assisted steering									
Number of turns lock to lock	3.1	3.1	3.1	3.1	3.1	3.1	3.1	3.1	3.1	3.1
Turning circle between kerbs (m)	10.2	10.2	10.2	10.4	10.4	10.4	10.2	10.4	10.4	10.4
<b>EXTERIOR DIMENSIONS (mm)</b>										
Length/Width/Height/Wheelbase	3948/1715/1483/2464									
<b>BOOT VOLUME (litres VDA)</b>										
Seats up – below parcel shelf	285	285	245	285	245	285	245	285	245	285

MPG figures are achieved under official EU test conditions, intended as a guide for comparative purposes only, and may not reflect actual on-the-road driving conditions.



This brochure is made from paper from a well-managed forest. Citroën support responsible use of forest resources.

Please don't throw me away, give me to a friend or recycle me.

NOTE: Please refer to the Citroën DS3 brochure for full technical specifications. Every endeavour has been made to ensure that the information and details contained in this brochure were accurate at the time of going to press February 2014. However the company reserves the right, whilst preserving the essential characteristics of the models described, to introduce at any time modifications, changes of details, equipment or accessories. Every effort will be made to bring this brochure up to date, but in order to avoid any misunderstandings please consult your Dealer. For full details of Citroën Care for Car and Driver, please see the full manufacturer's price list. The Citroën Website contains full information on all Citroën products and offers available in the UK, together with details of our environmental and recycling policies. The site address is: [www.citroen.co.uk](http://www.citroen.co.uk) or you can contact Citroën directly via [cuk\\_contactcentre@citroen.com](mailto:cuk_contactcentre@citroen.com)

**CITROËN** prefers **TOTAL**

**CITROËN UK Ltd.** Pinley House, 2 Sunbeam Way, Coventry CV3 1ND.

[www.citroen.co.uk](http://www.citroen.co.uk)

Designed and produced by Acuity

[www.weareacuity.com](http://www.weareacuity.com)

K12405 February 2014