



PONTIAC

2004 Grand Prix

Brochure Presented By:

Jim Hudson Buick GMC Cadillac Saab

7201 Garners Ferry Road Columbia SC 29209

www.jimhudsonsuperstore.com

reborn.

super charged

In taking the concept of driver's car to the next level, the thought arose: Might one car excel at everything? As a Pontiac Grand Prix, it would have to. The air, fuel, and spark combusting within it would ignite a feeling in you. It would have relentless power at its disposal, and the torque eager to translate that intensity. Its steering would be fluid in a parking lot, but total precision at performance speeds. It would offer a highly responsive automatic transmission that would be controlled like a manual. An impressive handling system as agile in traffic as when holding tight to a turn. Even standing still, you'd sense its power. The sinner yet saint of the driving world.

The Pontiac Grand Prix. REBORN

fuel for the

Some photos in this catalog may contain optional equipment.

hyper ventilation

THE MOST POWERFUL SPORT SEDAN IN ITS CLASS*

In an engine, air means power. The better an engine is at harnessing it, the more powerful it becomes. The tremendous surge of air through Grand Prix GTP's supercharged V6 elicits a 260-horsepower, 280 lb-ft torque force to be reckoned with (Grand Prix remains the only vehicle in its class serious enough about performance to offer a supercharged model**). With such unbridled power at your disposal, it's perfectly natural to want to see what it's made of.

* Unless otherwise specified, all claims based on comparably equipped front-wheel drive sedans in the 2003 *Automotive News* mid-range standard segment and latest information available at time of printing. Level of equipment varies.

**Excludes other GM vehicles.

Grand Prix GTP with available Competition Group Package in Galaxy Silver Metallic

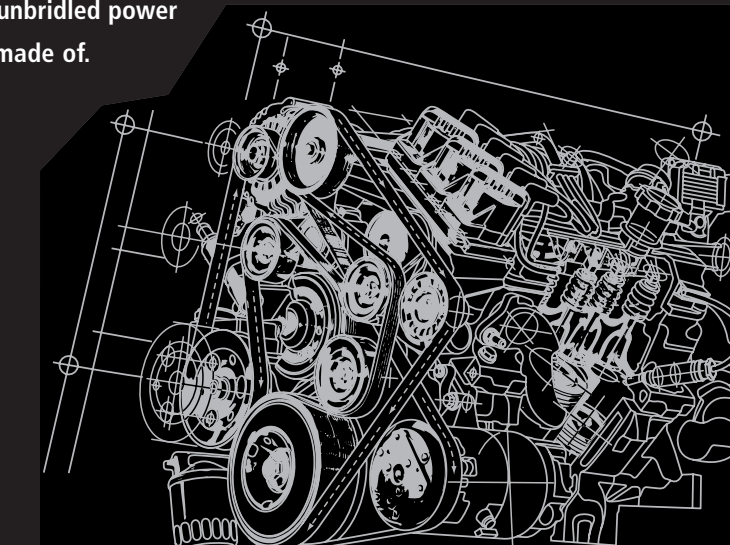

3800 SERIES III V6 ENGINES: TWO VARIATIONS, ONE POWERFUL THEME

Grand Prix's 3800 Series III V6 is built off an engine historically cited by *Ward's* as one of the 10 best in the U.S. Its standard version offers the largest engine displacement in its class,* translating to impressive engine output at low rpms—as well as minimal engine noise and fuel consumption.** A more powerful engine control module enhances its ability to manage engine timing, fuel injection, emissions, and other powertrain-related functions. This powertrain, standard on GT, has 200 horsepower and 230 lb-ft of torque, delivering instant acceleration when you need it. No entry-level car in its class has more horsepower.

Pushing this best-in-class notion even further, the supercharged V6 elevates output to 260 horsepower and a potent 280 lb-ft of torque. The new fifth-generation Eaton supercharger provides the feel of a V8 with the efficiency of a V6, offering improved horsepower and fuel economy.** It takes this philosophy all the way to the pump: While premium fuel is recommended for maximum performance, it runs quite capably on regular unleaded gasoline.

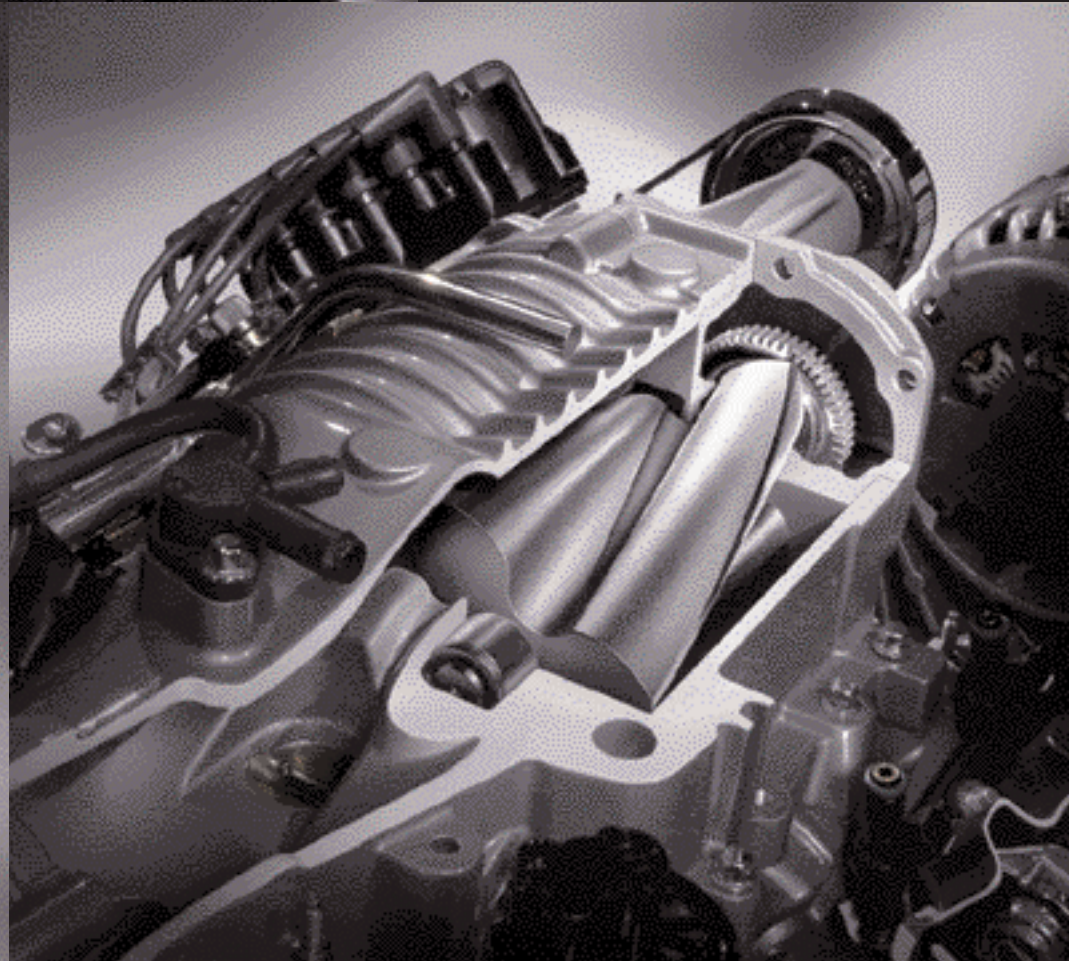
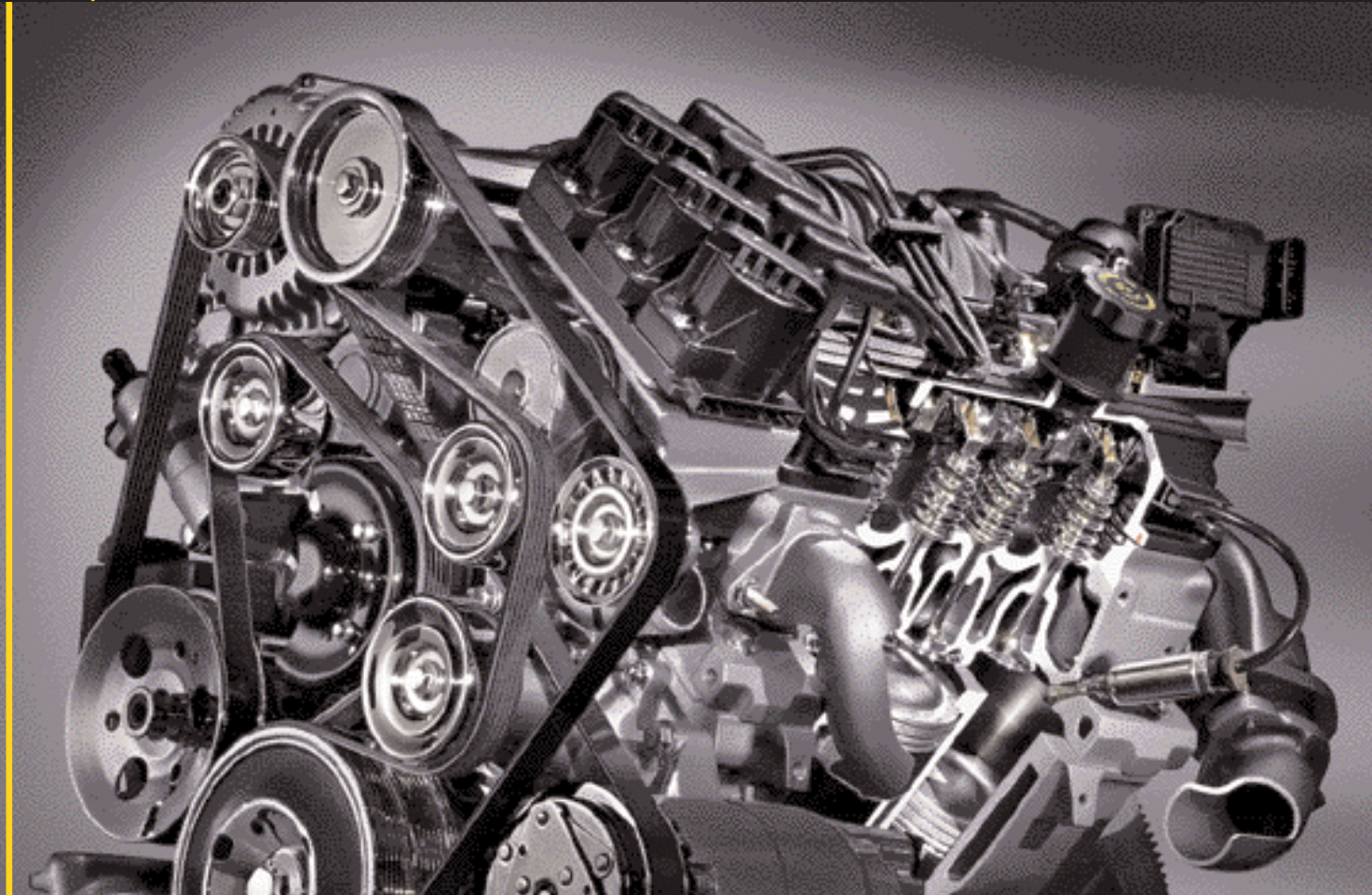

SPEED-BASED DRIVE-BY-WIRE ELECTRONIC THROTTLE CONTROL (ETC)

The only car in its class with this standard technology, ETC replaces the mechanical link between the accelerator pedal and throttle with electronic controls to provide immediate response. By tuning the throttle to 19 speed-based calibrations, this drive-by-wire system precisely modulates vehicle behavior for composure in parking lots and responsiveness on the highway.



reaction-timed

AN IMPRESSIVE COMBINATION OF HANDLING AND CONTROL

The emotional reaction Grand Prix generates is equal only to the connectivity it creates with the road. That came from taking Grand Prix's already formidable chassis to the next level—literally. This involved crafting a worthy successor to *WideTrack Handling*, a Grand Prix staple. So the next-generation WideTrack Handling System was born.

In its final tuning phases, engineers ran Grand Prix at a race course extensively to study its performance during extremes of acceleration, high-speed turns, maneuvering, braking, etc. The objective was not to turn it into a racecar. The philosophy was that if Grand Prix handled well in punishing track conditions, in more typical situations it would be superb.

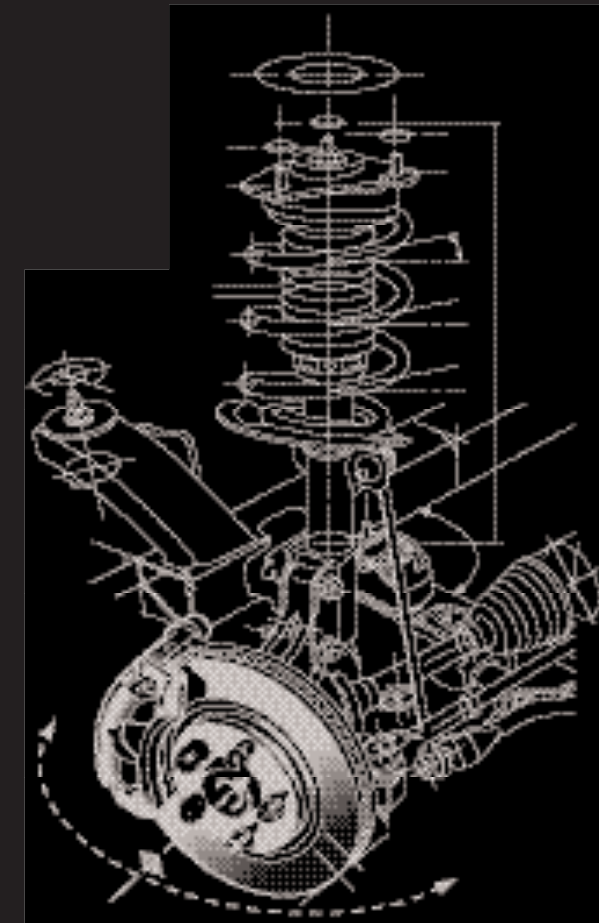

GT HP-Torque vs. Competition

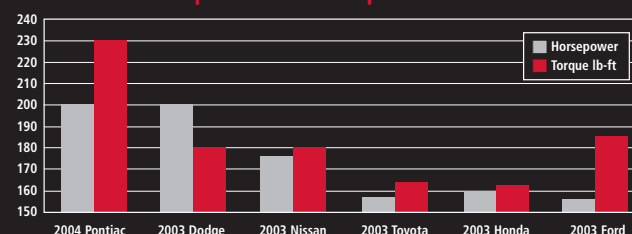

Base vehicle engine comparisons

GTP HP-Torque vs. Competition

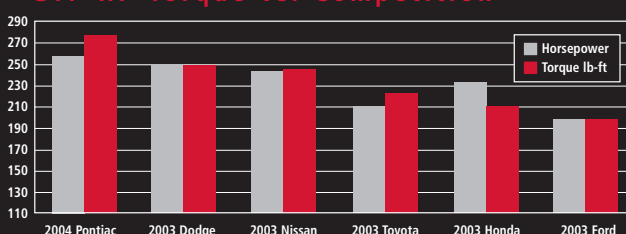

Uplevel vehicle engine comparisons

NEW "GEN 5" EATON SUPERCHARGER

Exclusive to the segment, this supercharger (GTP) boasts coated rotors and a ported housing. It also yields more power due to a larger and less restrictive outlet port and retuned inlet port. A belt driven by the crankshaft turns its interleaved impellers which, in essence, function as an air pump. This pump forces yet more air into the V6 engine, producing Grand Prix GTP's class-leading horsepower and torque numbers—and raising its performance considerably.

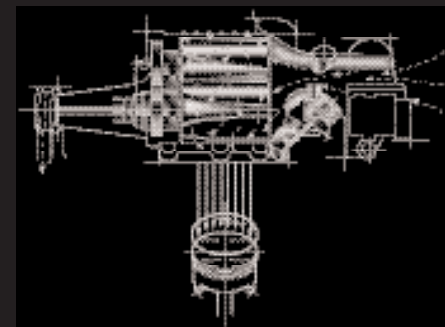

* Excludes other GM vehicles.
** EPA estimated mpg 20 city, 30 highway (GT); 18 city, 28 highway (GTP); and 18 city, 27 highway (Comp G).

THE NEXT-GENERATION WIDETRACK HANDLING SYSTEM

Every Grand Prix is equipped with six highly sophisticated components working in tandem to meld dynamic handling with superb control:

- Four-wheel independent suspension with quadra-stage valving offers a smoother, more responsive ride. Teflon-coated pistons are machined, not welded, for precise mounting that both reduces friction and improves performance.
- Direct-acting stabilizer bars in both the front and rear provide more efficient roll control for a flatter, more leveled ride when rounding curves. Rather than being attached to the control arm, the stabilizer bar is attached directly to the strut and moves in a one-to-one relationship with the wheel. The solid direct-acting bars vs. an indirect-mounted setup contributes 16% more stiffness and a smoothness to Grand Prix's ride. In addition: • 16" touring level tires • a lightweight 10-tooth steering shaft for improved steering sensitivity • a wider rear track for improved road grip and • an all-new, larger four-wheel disc braking system with Electronic Brake Force Distribution complete this highly capable handling package.

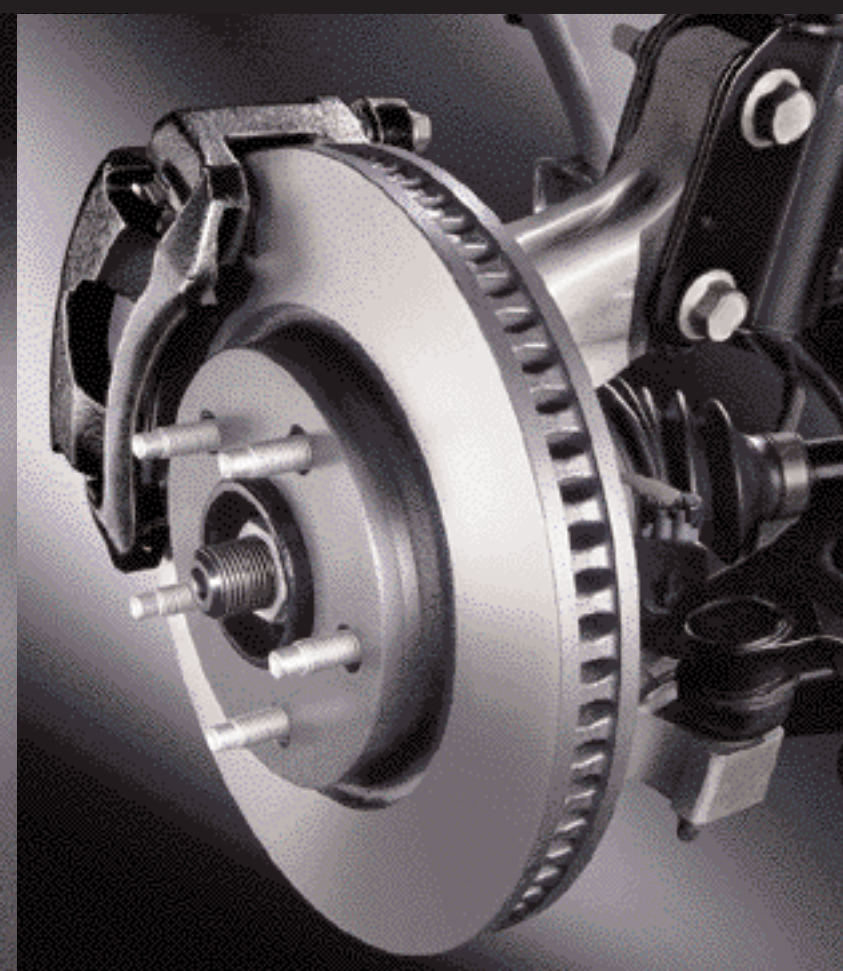
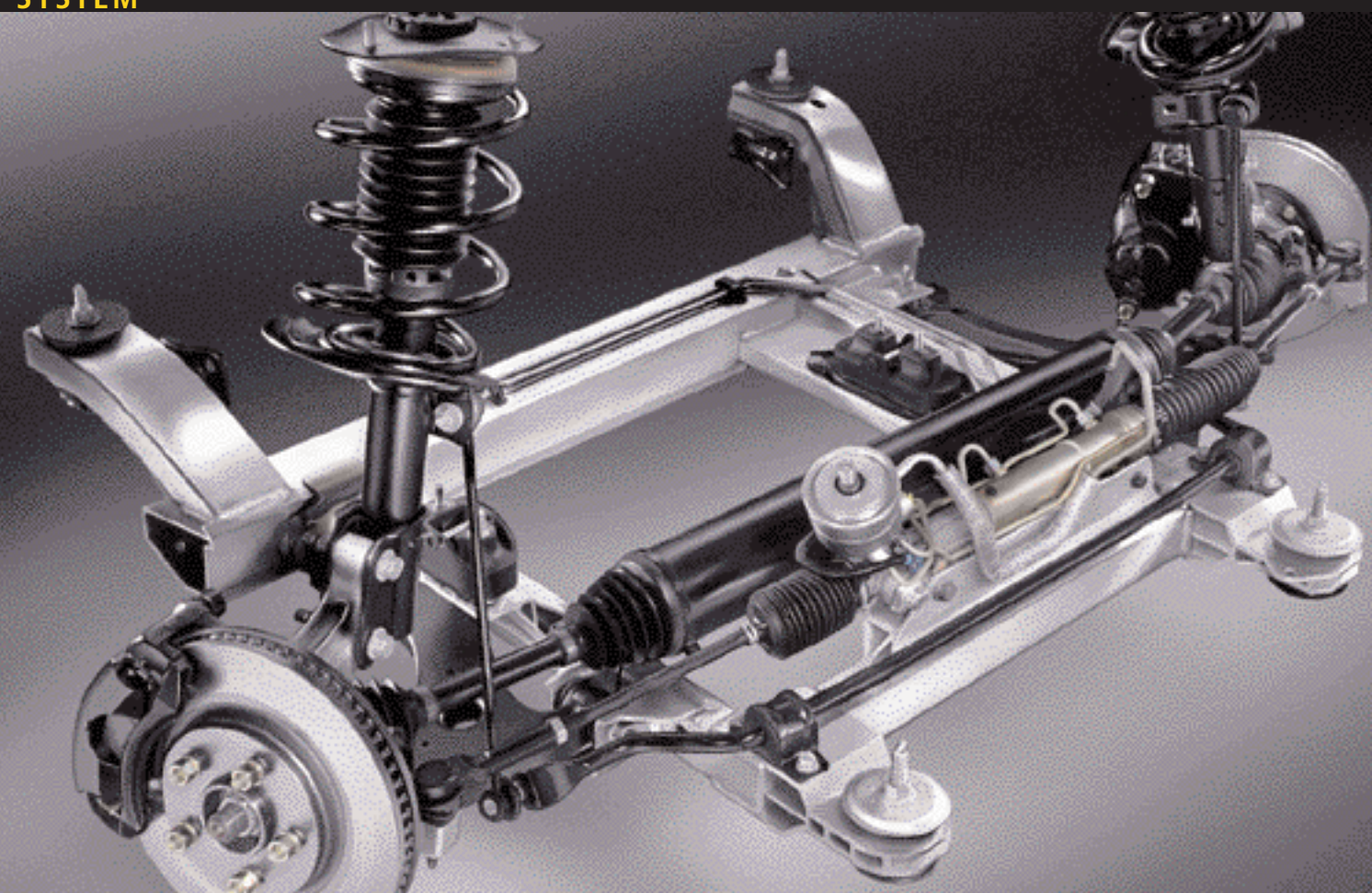

ALL-NEW FOUR-WHEEL DISC BRAKING SYSTEM WITH ELECTRONIC BRAKE FORCE DISTRIBUTION

This improves stopping power under various load conditions. A Bosch controller adjusts brake pressure toward the front or rear as needed. When the cabin is filled with passengers—or there's a lot of weight in the trunk—braking is more evenly distributed between front and rear. Also, stiffer calipers and tuned rotors reduce response time and decrease noise and pulsation felt through the brake pedal.

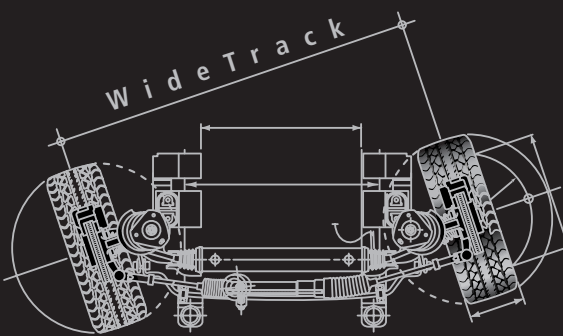

MODEL-SPECIFIC PERFORMANCE TIRES

Designed for Grand Prix are its touring level tires in 16" S-rated (GT) and 17" H-rated (GTP), which strike the necessary balance between handling and ride.

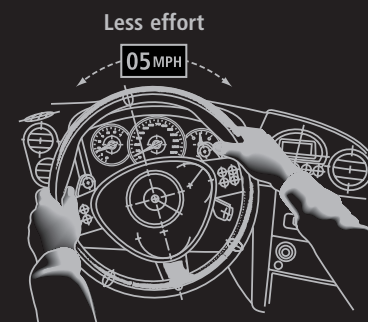
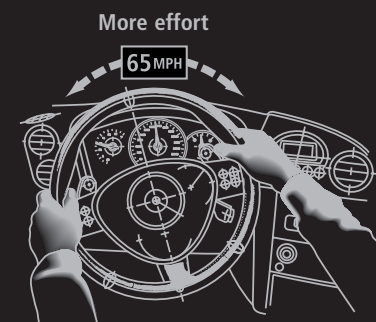

MAGNASTEER VARIABLE-EFFORT STEERING

Augmenting Grand Prix's sophisticated handling system, Magnasteer I (standard on GT2 and GTP) employs a computer-controlled electromagnet to adjust steering effort based on vehicle speed, requiring less effort, say, in a parking lot—or ease when parallel parking. At high speeds, steering retains the taut feel expected from a performance vehicle.



performance art

BEST-PERFORMING SPORT SEDAN IN ITS CLASS*—FOR SERIOUS ENTHUSIASTS

A badge with a reputation as serious about performance as Pontiac needs tangible proof of that commitment. Using Grand Prix as a foundation, GTP's available Competition Group Package (Comp G) was designed literally from the ground up to perform without peer. Its low-profile tires began the transformation; the sway bars, damping, spring and bushing rates, and remaining chassis elements were then tuned to push performance to another realm entirely.

Comp G makes no apologies about not being for everyone. Its distinctive road signature is defined by instant response, maximum grip, and precise steering, with a minimum sacrifice to ride quality. This is a machine proudly envisioned by enthusiasts, with, appropriately, enthusiasts in mind.

Grand Prix GTP with available Competition Group Package in Graystone Metallic

GT
COMPETITION

*All claims based on Grand Prix GTP with Competition Group Package vs. comparably equipped front-wheel drive sedans available at time of testing in the 2003 Automotive News mid-range standard segment. Level of equipment varies. Testing performed by Pro Performance and sanctioned by SCCA.

OVER 41,000 MILES. 1,400 HOURS. 17 VEHICLES. 5 TESTS. 1 OVERALL WINNER.

Believing the Comp G to be superior was one thing; proving it was another. At Firebird International Raceway in Chandler, Arizona, Comp G's total performance characteristics were scrutinized against 16 of its competitors in five driving tests (see chart), with all electronic systems in their normal "key on" positions. Comp G won four of the five trials outright in composite handling, acceleration, braking, and slalom, demonstrating its performance superiority. And when the BMW 330i, Audi A6 3.0, and Jaguar S-Type 3.0 were thrown into the mix, Grand Prix overwhelmed the A6 in every trial, bested the S-Type in four of them (tying the fifth), and defeated the 330i in road course time and acceleration, remaining its toughest competitor on other tests. Apparently, the perceived "gold standards" need to make room for another vehicle clearly worthy of the designation.



	COMPOSITE ROAD COURSE LAP TIME (SECONDS)	ACCELERATION QUARTER MILE TIME (SECONDS)	BRAKING 60-0 MPH DISTANCE (FT.)	LATERAL Gs 100' SKID PAD (FT.)	TRANSITION 600' SLALOM SPEED (MPH)
'04 Grand Prix GTP*	43.328	15.015	112.3	0.827	62.47
'03 Maxima SE	44.469	15.496	120.5	0.822	61.26
'03 Concorde LXi	44.229	16.181	115.0	0.793	61.23
'03 Sebring LXi	44.811	16.400	114.0	0.783	61.36
'03 Accord EX	44.447	15.314	119.8	0.766	60.08
'03 Altima 3.5SE	43.957	16.766	120.0	0.844	59.76
'03 Camry XLE	44.915	16.408	113.5	0.799	59.31
'03 Intrepid SXT	45.008	16.047	122.5	0.803	61.51
'03 Galant GTZ	45.003	16.424	118.5	0.784	61.73
'03 Passat GLX	45.351	16.620	118.3	0.802	60.64
'03 Intrepid SE	45.620	17.524	120.5	0.799	61.47
'02 XG350	46.206	16.115	117.5	0.745	58.65
'03 Avalon XLS	45.759	16.355	125.0	0.766	58.58
'03 Sable LS	45.824	16.265	128.5	0.789	58.33
'03 Taurus SES	45.671	16.287	129.5	0.774	59.55
'02 Diamante	45.719	16.313	133.8	0.792	58.92
'03 Taurus SEL	45.782	16.396	130.8	0.774	57.71

FASTEST TIME
Maneuvered through the road course faster than any other sport sedan in its class.

BEST ACCELERATION
Class-leading supercharged acceleration.

BEST BRAKING
The shortest 60-0 mph stopping distance of any sport sedan in its class.

IMPRESSIVE Gs
An impressive road holding capability of .83 lateral Gs, better than some European performance sedans.

FASTEST SLALOM
Carved through the slalom faster than any other sport sedan in its class.

Outperformed the Audi A6 3.0 in every test and the Jaguar S-Type 3.0 in four out of five performance and handling tests (tying the fifth).

Defeated the BMW 330i in composite road course time and acceleration (and was its strongest competitor on other tests).

Visit pontiac.com/grandprix for complete test results.



*All claims based on Grand Prix GTP with Competition Group Package vs. comparably equipped front-wheel drive sedans available at time of testing in the 2003 Automotive News mid-range standard segment. Level of equipment varies. Testing performed by Pro Performance and sanctioned by SCCA.

PERFORMANCE SUSPENSION

Numerous performance tweaks were made throughout Comp G's suspension; for instance, its bigger rear stabilizer bar. Dampers are designed with internal rebound springs; bushing rates on the front lower control arms are tuned about a third higher than in the GTP to provide less body roll and its characteristic firm yet compliant ride. Complementing these modifications, its Magnasteer II boasts a specific variable-effort steering curve, employing the yaw sensor from StabiliTrak Sport (see below) to analyze Comp G's lateral acceleration along with its vehicle speed for an even more precise response behind the wheel.



THE NEW DEFINITION OF TOTAL PERFORMANCE

Comp G's performance vision rests upon its 17-inch low-profile, performance V-rated tires. These tires frame 10-spoke, lightweight aluminum machine-finished wheels, through which red-painted brake calipers are clearly visible. The segment-exclusive steering wheel-mounted TAPshift mode transforms its automatic transmission to operate much like a crisp manual. An InfoTech Package that includes Head-Up Display (HUD) projects Comp G's gear position, mph, and other data on the windshield, and a trip computer keeps unseen vehicle functions both in check—and in view. StabiliTrak Sport, its stability control system, helps the driver manage vehicle direction with nearly imperceptible intrusion. Finally, a 3.29 axle ratio complements its aggressive handling package, securing Comp G's thoroughly comprehensive performance status.



Grand Prix GTP with available Competition Group Package in Black

competition group



TAPshift

Shorthand for Touch Activated Power, this manual mode has ergonomically designed steering wheel-mounted control paddles. Borrowed from Formula One cars, a subtle movement of the paddle forward or backward rapidly executes the shift. Like a true manual, it holds gear at redline (on a downshift request, if the system predicts an over-rev condition, it will deny the shift). Comp G's Head-Up Display also lists TAPshift's gear position, and, taking a cue from LeMans, a performance upshift light alerts the driver before redline to optimize gear shifts. This mainline to Grand Prix's innermost workings lets drivers maximize both the driving experience and control.

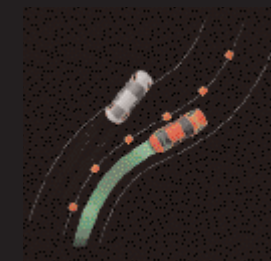

STABILITRAK SPORT

This performance-tuned, four-channel vehicle stability control system is designed to provide an added degree of safety, yet not interfere with a more aggressive driving style. Its progressive actuation subtly intervenes to help maintain the driver-intended path.

driver-tuned

GRAND PRIX: AN AUTHENTIC DRIVER'S CAR

The interior design theme of Grand Prix was *cockpit*. The watchword was refinement. The objective was a visceral connection of a driver to a car.

True to this philosophy, Grand Prix's driver-angled instrument panel gives complete command and control to the person behind the wheel. The rest of the interior is designed with equal purpose and intent, a need fulfilled. The end result? A perfect blend of performance and decorum that creates a powerful driving experience.



A COMMAND CENTER OF INFORMATION; AN UNPRECEDENTED FEELING OF CONTROL

Ergonomics and performance guided the design and perspective from the driver's seat. Controls sweep around the driver. Gauges are stacked and have a performance bent. The trunk release is thoughtfully mounted on the door. Two auxiliary power outlets are console-mounted. Even inserting the key in the ignition signals the decisively different experience of Grand Prix. The switch is located on the instrument panel rather than the steering column, for easy sight and reach.



AVAILABLE HEAD-UP DISPLAY

This projects instrumentation cluster information on the windshield—everything from speed to turn signals to outside air temperature to compass to sound system settings—so eyes stay on the road. Its exclusive stealth mode even allows drivers to shut off instrumentation cluster lighting for performance night driving.



RECONFIGURABLE DRIVER INFORMATION CENTER (DIC)

From the odometer readout to the tire inflation monitor, up to 14 key vehicle messages are visible at a glance—on one of the largest display screens offered on any midsize sedan. Offering readouts in English, Spanish, and French, it also allows drivers to program door locks and interior lighting to their liking. The optional five-button system (shown) includes additional features like engine hours, fuel economy, outside temperature, and a compass.

IN-DASH SIX CD CHANGER

The available factory-installed six-disc in-dash CD player features nine Monsoon premium speakers, which flood the cabin with 245 watts of high-performance sound. The system includes a pair of coaxial subwoofers integrated in the package shelf with their own amplifier and a center channel speaker mounted on the instrument panel. The optional XM Satellite Radio* band on GT2 and GTP presents over 100 channels of coast to coast digital-quality music, talk, sports, comedy, and children's programming by subscription.



IMPROVED ELECTRONIC CLIMATE CONTROL

Remarkably quiet, its design offers 13 modes versus the typical four or five for better performance. Instead of regulating airflow by cable-operated valves, unique film valve technology directs airflow via a thin sheet of plastic guided by an electric motor for better circulation. Controls for air recirculation, the rear-window defroster, and the air conditioning compressor are housed within this unit, as are buttons for the optional heated front seats. The system's pollen filter traps dust and pollen before it enters the passenger compartment.



AVAILABLE STEERING WHEEL CONTROLS

These allow drivers to activate the radio's volume, seek, band, presets, and mute functions without taking their hands off the wheel.



Careful attention was paid to interior materials, textures, and finishes, and the way each harmonizes with one another. Thicker door window glass, enhanced baffles in body panels, and ultra-light acoustical materials result in a quiet cabin. Satin nickel accents are thoughtfully placed, faceplates are flush, and fit is taut and precise throughout.

Grand Prix's front seats have a new side-bolstered, ergonomic design that is comfortably snug and supportive. Keeping comfort a priority, available leather-trimmed seating is perforated for breathability. But that's really only half the story: The interior boasts a versatility never before seen in a Grand Prix.

switch gears

*Activation and subscription fees apply. Available only in the 48 contiguous United States. Visit www.gm.xmradio.com for further details.

THE MOST VERSATILE SPORT SEDAN IN ITS CLASS

Versatility is not a word typically associated with performance cars. Grand Prix shifts the paradigm. Its interior is sporty and sleek, but designed with an understanding that people today use vehicles differently.

Grand Prix easily reconfigures to accommodate countless demands. Shown to the right with the Lifestyle Package (standard on GT2 and GTP), versatility features include a folding front passenger seatback that converts to a tabletop work area.*



SPLIT-FOLDING, FOLD-FLAT REAR SEATBACKS

Designed in a 60/40 configuration, the seatbacks, when folded, more than double trunk space. With the available folding front seat lowered as well, cabin storage swells to that of a compact SUV, so even a nine-foot object can be stowed inside—with the trunk shut. The trunk's reversible cargo mat has one side carpeted and the other side vinyl-coated for goods that demand it. Along with these, an "envelope" cargo net offers many configurations, each based on what needs to stay put. And covered cargo storage keeps selected items unseen.

*Secure loose items and do not use laptop while driving.



ENLARGED TRUNK PASS-THROUGH

This larger opening creates more room between the passenger compartment and the trunk for typically tough-to-stow stuff. Thoughtful design defines the trunk: By employing gas-strut openers instead of gooseneck hinges, packages and luggage sidestep getting crushed. The trunk's wider, low-liftover decklid means there's no problem loading or unloading heavy, bulky items. And inside, thoughtfully positioned cargo tie-downs help secure things in place.



Near 90-degree opening rear doors mean easier entry and exit for people and things. A segment-exclusive third opening position (beyond the usual two) extends rear doors out to their widest point, if desired. Now, even oversized television boxes can be loaded in the back seat instead of the trunk. In short, when versatility is required, there's no need to drive home and switch vehicles. It's designed right into Grand Prix.



Grand Prix GTP with available Competition Group Package shown with Parchment leather-trimmed seating with Parchment/Dark Pewter interior trim

DESIGNED TO BE THE SAFEST GRAND PRIX EVER

The 2004 Grand Prix offers the most active and passive safety features ever designed into the nameplate. Its safety cage construction adds rigidity to the entire vehicle in the event of a collision. Along with this, a host of other structural enhancements are designed to comprehensively protect its passengers.

In terms of being a performance vehicle, safety is yet another component of how Grand Prix was thoroughly conceived to perform.

driving force



OCCUPANT PROTECTION

Dual-stage front air bags* use a two-stage inflator that adjusts the deployment of the driver and front passenger's air bags based on the severity of the collision. At a slower-speed frontal collision, one stage is triggered to provide a reduced-power air bag deployment; in a higher speed frontal collision, full deployment occurs for a greater counteracting force against impact. Optional head curtain air bags operate along the periphery of Grand Prix. During side impacts, these provide head protection for both front and rear window-seated passengers.

*Air bag inflation can cause severe injury or death to anyone too close to the air bag when it deploys. Be sure every occupant is properly restrained.



PASSIVE SAFETY

- Dual-stage front air bags
- Safety cage construction
- Front and rear crush zones
- Side-impact crash protection:
 - Front- and rear-door energy absorbers
 - Rocker panel reinforcements
 - A redesigned thicker B-pillar
- Optional head curtain side air bags (available on GT2 and GTP)

ACTIVE SAFETY

- Four-wheel anti-lock braking system (available on GT1, standard on GT2 and GTP)
- Enhanced Traction System (standard on GT1 w/ABS, standard on GT2)
- Uplevel full-function all-speed traction control (standard on GTP)
- Tire Inflation Monitor System (included with ABS)
- Head-Up Display (available on GT2 and GTP)
- StabiliTrak Sport (standard on GTP with Comp G)
- Magnasteer (standard on GT2 and GTP)
- Daytime running lamps and fog lamps
- OnStar telematics with one-year Safe and Sound Service* Plan (available on GT2, standard on GTP)
- High-intensity halogen quad-beam driving lamps

ADDITIONAL OCCUPANT PROTECTION

- Three-point safety belts at all seating positions
- Force limiters on front safety belts
- Lower anchors and top tether anchors for child seats (LATCH)
- Automatic door locks
- Remote keyless entry
- PASS-Key III
- Contents theft-deterrent system
- Emergency trunk release handle

Note: All features above are standard on all models unless otherwise noted. * Visit www.onstar.com for system limitations and details. See "A NOTE ABOUT CHILD SAFETY" on final page.

AVAILABLE ONSTAR TELEMATICS

With a variety of services that help keep you safe when you're on the road, the OnStar® Safe & Sound Plan offers its subscribers added peace of mind. A highly trained OnStar Advisor can contact roadside assistance for you, assist local authorities in locating your car if it's stolen, and help unlock your doors if you lock your keys in the car. OnStar Advisors will call to find out if you need help when your air bags go off, and can pinpoint your location by satellite and contact a nearby emergency service provider, like the police or an ambulance. For more information, visit onstar.com.



SAFETY WITHIN THE CABIN

Programmable power automatic door locks enhance safety with lockout protection. Standard door locks latch immediately when Grand Prix is put into gear, and unlock when shifted into park. Remote keyless entry is also standard, and comes with a contents theft-deterrent system that sounds an alarm if tampered with. Additionally, should an unauthorized person attempt to start the engine without the properly coded key, PASS-Key disables the ignition.



GRAND PRIX QUALITY, RELIABILITY, AND DURABILITY SET A NEW STANDARD

GRAND PRIX'S NEW ELECTRICAL SYSTEM ARCHITECTURE

This integrates the functions of individual microprocessors onto the same chip. And now, a single wire carries multiple component messages, reducing connections and thereby boosting reliability.

A NEW GLASS MAT BATTERY

It makes use of a compressed glass composite similar to fiberglass, which, unlike typical batteries, eliminates the need for liquid electrolyte within the battery. This heightens its tolerance to underhood temperatures and its durability. Tested in a taxi fleet in Las Vegas, its average battery life was 117,731 miles, 160% longer than conventional batteries. Grand Prix customers can expect a 500% reduction in failure rate, which should virtually eliminate battery replacements over the life of the vehicle.

QUAD HEADLAMPS

Pushing conventional halogen technology, these yield a better illumination path—and achieve world-class lighting performance.

NEW ALUMINUM ENGINE CRADLE

Adding dynamic stiffness while reducing weight, the new aluminum alloy cradle has a natural frequency of 81 HZ—nearly 20 HZ over the steel cradles formerly used in Grand Prix—indicative of the minimal oscillation conveyed to the passenger compartment.

CRADLE-MOUNT STABILIZER BRACKETS

These new brackets add structure around the mount and the attachment bolt, improving mount efficiency for improved ride and handling.

FOG LAMPS

Positioned at the lower corner of the fascia with the parking and turn lamps, these accentuate the car's width and emit light low and forward on the road.

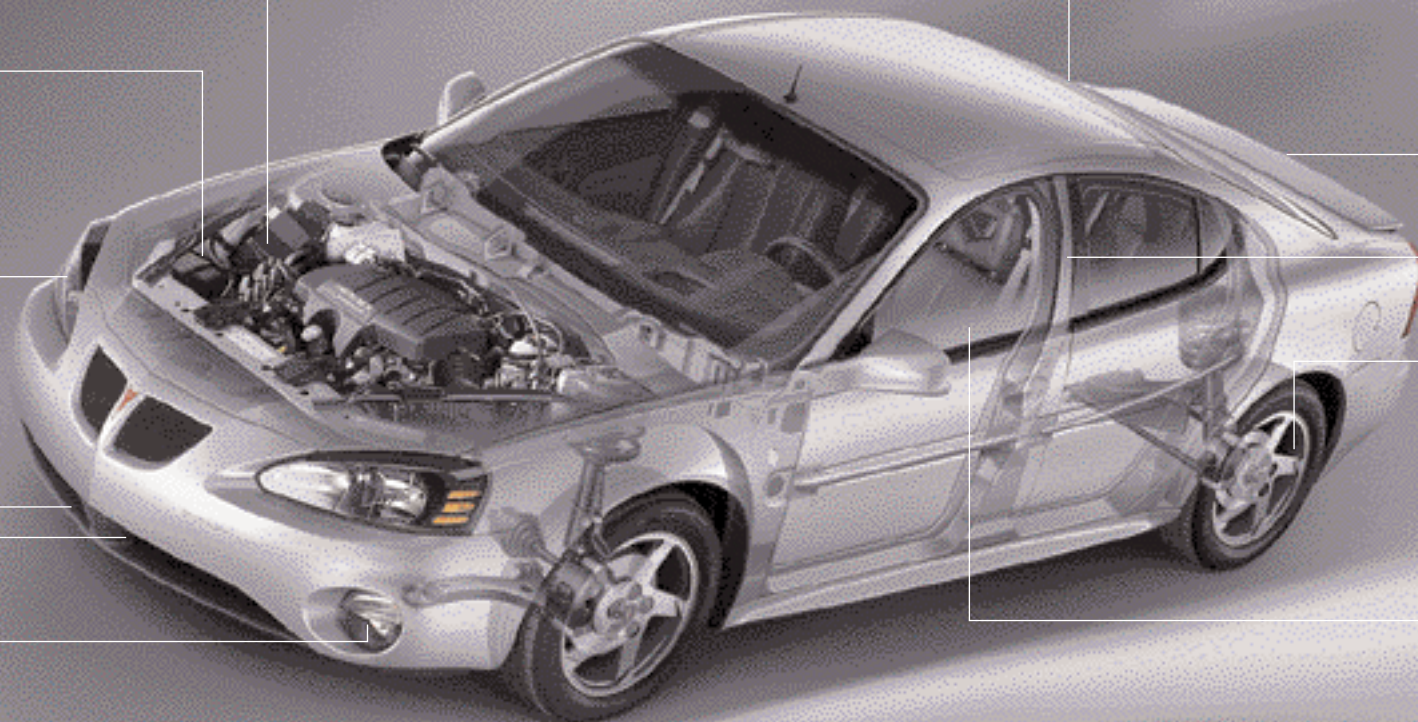

When you're aiming to build a great car, it requires a great production facility. Near Toronto, Ontario, the '04 Grand Prix's Oshawa Assembly Plant #2 is such a place. It ranked first in assembly plants throughout North America in the 2002 J.D. Power and Associates Initial Quality Study.SM Using robotic automatic guided vehicles for assembly, automating 97% of its welds, and incorporating site cameras and coordinate measuring machinery to provide accuracy to 1/1000th of an inch, Grand Prix is the personification of technological prowess.

Among plants producing vehicles for the U.S. market. Study based on a total of 64,905 U.S. consumer responses indicating owner-reported problems during the first 90 days of ownership. www.jdpower.com

LIGHTWEIGHT MATERIALS

Unnecessary weight diminishes all aspects of vehicle performance—acceleration, handling, braking, and fuel efficiency. Grand Prix uses advanced materials that provide the desired function with minimal weight penalty. A perfect example of this is its cast magnesium cross-car beam. It provides a stiffer, more secure steering column mount, also telegraphing less vibration to the steering wheel and virtually eliminating squeaks and rattles.

A STANDARD REAR SPOILER

The fin is not just for show. It integrates a central brake lamp, and contributes to Grand Prix's .31 drag coefficient.

SINGLE-PIECE SIDE-BODY FRAME STRUCTURE

Literally, the body panel was stamped from a single piece of metal. This cuts down the number of welded joints and ensures a tighter fit between the side panels and the doors.

LARGER WHEELS

Serving as a critical road interface—and initial suspension system—16" and 17" wheels and tires contribute to Grand Prix's total performance.

ENVIRONMENTALLY THOUGHTFUL

The returnless fuel system—along with a new vapor purge valve—cuts down on evaporative emissions. In addition, the close-coupled catalytic converter lights off faster to reduce exhaust emissions. And although premium fuel is recommended for peak performance, Grand Prix's supercharger can tolerate regular fuel without engine damage.

NOTICEABLY TIGHTER FIT—AND QUIETER INTERIOR

Chalk this up to advancements literally from all sides: enhanced baffles in body panels; thicker door window glass; a new rearview mirror design; even a U-lip windshield seal. And running counter to the prevailing philosophy of sound reduction, ultra-light acoustical materials used in Grand Prix deaden sound not by reflecting it, but by absorbing it, thereby swallowing unwanted noise from the passenger cabin. Also, with a new compressor and new electronic design, the climate control system is far more silent, too, and offers better performance. Together, these create a noticeably quieter cabin at all speeds.

dominant traits

Attention to detail is essential to make a true performance car. That same mindset also makes Grand Prix a machine of unmistakable quality. The result is a driver's car whose craftsmanship delights owners immediately—and is designed to continue to as its odometer pushes six figures and well beyond.



PRECISION FIT AND FINISH

By balancing leading-edge styling and design execution with manufacturing, Grand Prix strives to achieve what engineers call a "jewel effect." The term is used to describe body fits and finishes that are both pleasing to the eye and define a well-built vehicle. The '04 Grand Prix is designed to have the best fit and finish ever for the nameplate, with tolerances that result in tighter gaps.

SETTING THE PACE, SECURING VICTORY: TWO PONTIAC TRADITIONS

Pontiac is synonymous with the track; it's at the heart of what Pontiac stands for. It's an addiction to speed, its flickering blur, its explosive roar. It's an obsession about a line drawn across a straightaway.

And a fixation on a hundredth of a second.

NASCAR stays with us long after those intoxicating Sundays are over. It inspires concepts that echo racing's competitiveness. Hones internal components that can withstand equally punishing trials. Creates vehicles born from the same passion. (Or, like the 2004 Grand Prix, reborn from it.)

There's a reason why Grand Prix has won the Driver's Championship two of the last three years. Why Pontiac Grand Prix has been the Official Pace Car of NASCAR for 33 years. And why an all-new Pontiac racing body for the 2003 circuit should continue a dominant tradition.

Racing lovers know you don't have to be behind a steering wheel for it to pump the heart. Lighten the head. Electrify the senses. It's as black and white to certain people as a checkered flag. It's fuel for the soul.

one track mind



The Driver's Championship is the most prestigious achievement in NASCAR racing. And Grand Prix has won it twice in the past three years. That tracks perfectly with the Pontiac dedication to performance.



OFFICIAL PACE CAR OF

- 32 Ricky Craven
- 01 Jerry Nadeau
- 4 Mike Skinner
- 10 Johnny Benson
- 0 Jack Sprague

Inspired by the Grand Prix show car that travelled the 2002 auto show circuit, these accessories give you an opportunity to make Grand Prix even more resolutely yours alone.

Each of these dealer-installed parts has been tested to meet rigorous GM standards and carries the 2004 Grand Prix new-vehicle limited warranty. Feel free to select them when ordering your Grand Prix; any authorized Pontiac dealer will be more than happy to install them for you.

street legal accessories



REAR SPOILER

Designed to be both more prominent and expressive than the standard issue spoiler, the Grand Prix show car heavily guided its design. Bolting directly to the decklid (just like its standard counterpart), it's available in Black, White, Sport Red, and Galaxy Silver—or can be ordered primed.



GRILLE INSERTS

Executed with a large hex pattern, the grilles are flush with the fascia and finished in a light satin nickel.

DUAL ROUND EXHAUST TIPS

These stainless steel, four-pipe fittings are each three inches in diameter. Influenced liberally by the Grand Prix show car, they offer a sporty alternative for Grand Prix's distinctive quad-port exhaust setup.





Parchment cloth with Parchment/Dark Pewter interior trim



Parchment leather-trimmed seating with Parchment/Dark Pewter interior trim



Dark Pewter Cloth with Dark Pewter interior trim



Dark Pewter leather-trimmed seating with Dark Pewter interior trim

When it comes to picking your interior, the 2004 Grand Prix offers four premium options, each a perfect complement to any exterior color you choose.

All textiles and leathers were chosen to offer the greatest combination of comfort and refinement.

interior themes

EXTERIOR COLORS



12 Galaxy Silver Metallic



47 Polo Green Metallic



15 Sedona Beige Metallic¹



56 Fusion Orange Metallic



40 Ivory White



63 Sport Red Metallic



41 Black



88 Graystone Metallic¹

¹Available July 2003.

GRAND PRIX'S MODEL LINEUP:

GT1

STANDARD EQUIPMENT

- **Next-generation WideTrack Handling System:** Includes 4-wheel independent suspension with quadra-stage valving technology, direct-acting stabilizer bars, new larger 4-wheel disc braking system, P225/60R16 S-rated touring tires, improved steering sensitivity, and wider rear track
- 3800 Series III V6 engine with Electronic Throttle Control (200 hp/230 lb-ft torque)
- 4-speed automatic transmission
- 60/40 split-folding rear seatbacks
- Air bags, driver and front passenger*
- Air conditioning
- Analog instrument cluster with tachometer
- Console, front center with floor shifter, armrest, storage, and two auxiliary power outlets
- Contents theft-deterrent system
- Cruise control
- Daytime running lamps
- Doors, near 90-degree opening rear doors
- Driver Information Center, 3-button with up to 14 key vehicle functions
- Fog lamps
- PASS-Key III theft-deterrent system
- Polished aluminum dual exhaust outlets
- Pollen filter
- Power door locks, programmable, enhanced safety, includes lockout protection
- Power sport mirrors, body-color
- Power windows with driver's express-down
- Rear defogger, electric
- Remote keyless entry
- Seats, front bucket
- Spoiler, rear aerodynamic
- Sound system, AM/FM stereo with CD player, equalizer, and 6 speakers
- Tilt steering column
- Trunk release, electronic
- Wheels, 16" 5-spoke bolt-on wheel covers

OPTIONAL EQUIPMENT

- **Driver's Package:** 16" aluminum 5-spoke wheels, 6-way driver's power seat, front and rear floor mats
- AM/FM stereo with CD player, cassette, and programmable equalizer
- Brakes, 4-wheel anti-lock with Enhanced Traction System and Tire Inflation Monitor System
- Engine block heater

GT2

STANDARD EQUIPMENT INCLUDES GT1 STANDARD EQUIPMENT PLUS:

- **Driver's Package:** Includes 16" aluminum 5-spoke wheels, 6-way driver's power seat, front and rear floor mats
- **Lifestyle Package:** Includes front passenger folding seatback, reversible cargo mat, covered cargo storage, cargo net
- **Premium Lighting Package:** Includes rear assist handles, lighted visor vanity mirrors, reading lamps, overhead console with storage
- Brakes, 4-wheel anti-lock with Enhanced Traction System and Tire Inflation Monitor System
- Magnasteer variable-effort power steering
- Steering wheel radio controls with leather-covered steering wheel rim and shift knob

OPTIONAL EQUIPMENT

- **InfoTech Package:** 5-button trip computer with key vehicle functions and Head-Up Display (HUD)
- **Leather Trim Package:** Includes leather-trimmed seating, 4-way power driver lumbar, and heated driver and front passenger seating areas
- **Premium Audio Package:** Includes in-dash 6-disc CD changer and 245-watt Monsoon 9-speaker system plus amplifier
- Air bags, head curtain side impact*
- AM/FM stereo with CD player, cassette, and programmable equalizer
- Engine block heater
- Lumbar, driver's 4-way power (cloth interior)
- Power sunroof, spoiler-type
- OnStar with one-year Safe and Sound Service Plan**
- Wheels, 16" aluminum, 5-spoke chrome finish
- XM Satellite Radio, 100 channels of digital-quality sound. Activation and service fees apply.[†]

GTP

STANDARD EQUIPMENT INCLUDES GT2 STANDARD EQUIPMENT PLUS:

- 3800 Series III Supercharged V6 engine with Electronic Throttle Control (260 hp/280 lb-ft torque)
- P225/55-R17 H-rated touring tires
- Wheels, 17" 5-spoke aluminum, silver painted
- Full-Function Traction Control
- Lumbar, driver's 4-way power
- OnStar with one-year Safe and Sound Service Plan**

OPTIONAL EQUIPMENT

COMPETITION GROUP PACKAGE

Specific suspension tuning, TAPshift, InfoTech Package, StabiliTrak Sport, Magnasteer II, P225/55-R17 V-rated performance tires, 17" 10-spoke light-weight aluminum machine-finished wheels, red painted brake calipers, 3.29 axle ratio

- **InfoTech Package:** 5-button trip computer with key vehicle functions and Head-Up Display (HUD)
- **Leather Trim Package:** Includes leather-trimmed seating, 4-way power driver lumbar, and heated driver and front passenger seating areas
- **Premium Audio Package:** Includes in-dash 6-disc CD changer and 245-watt Monsoon 9-speaker system plus amplifier
- Air bags, head curtain side impact*
- AM/FM stereo with CD player, cassette, and programmable equalizer
- Engine block heater
- Lumbar, driver's 4-way power (cloth interior)
- Power sunroof, spoiler-type
- Wheels, 17" aluminum, 5-spoke chrome finish
- XM Satellite Radio, 100 channels of digital-quality sound. Activation and service fees apply.[†]

*Always use safety belts and proper child restraints, even in vehicles with air bags. Children are safer when properly secured in a rear seat. See Owner's Manual for more safety information.

**Visit www.onstar.com for system limitations and details.

[†]Available only in the 48 contiguous United States. Visit www.gm.xmradio.com for details.

WHEELS

GT1

STANDARD WHEEL COVER



QB5 16" black painted steel wheel with silver painted bolt-on wheel covers

OPTIONAL WHEEL



QD1 16" aluminum, 5-spoke, silver painted

GT2

STANDARD WHEEL



QD1 16" aluminum, 5-spoke, silver painted

OPTIONAL WHEEL



QD1/14P 16" aluminum, 5-spoke, chrome finish

GTP

STANDARD WHEEL



N85 17" aluminum, curved 5-spoke, silver painted

OPTIONAL WHEEL



N85/14P 17" aluminum, curved 5-spoke, chrome finish (Optional on GTP and Comp G)



PO4 17" 10-spoke, lightweight aluminum machine finished (Standard on Comp G)

CAPACITIES

Curb weight (lbs.)	3477 (GT1) 3484 (GT2) 3583 (GTP)
Cargo volume, trunk (cu. ft.)	16.0
Cargo volume, trunk plus rear seats down (cu. ft.)	45.7
Cargo volume, trunk plus rear and front passenger seats down (cu. ft.)	57.0
Fuel capacity, approximate (gallons)	17.0
Seating capacity (front/rear)	2/3

PERFORMANCE

BASE ENGINE:	3800 Series III V6 with Electronic Throttle Control Horsepower: 200 Torque: 230 lb-ft Axle ratio: 3.05:1 EPA estimated fuel economy (miles per gallon) City: 20; Highway: 30
SUPERCHARGED ENGINE:	3800 Series III Supercharged V6 with Electronic Throttle Control Horsepower: 260 Torque: 280 lb-ft Axle ratio: 2.93:1 (GTP) 3.29:1 (GTP w/Comp G) EPA estimated fuel economy (miles per gallon) City: 18; Highway: 28 (GTP) City: 18; Highway: 27 (Comp G)

INTERIOR DIMENSIONS (inches)

Head room, front	38.8
Head room, rear	36.2
Shoulder room, front	58.0
Shoulder room, rear	54.8
Hip room, front	54.5
Hip room, rear	54.3
Leg room, front	42.2
Leg room, rear	36.2

EXTERIOR DIMENSIONS (inches)

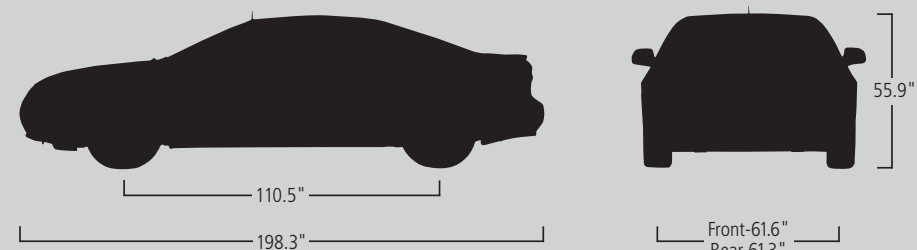

A WORD ABOUT THIS CATALOG

We've tried to make this catalog comprehensive and factual. We reserve the right, however, to make changes at any time, without notice, in prices, colors, materials, equipment specifications, models, and availability. Since information may have been updated since the time of printing (March 2003), please check with your Pontiac dealer for complete details. Pontiac reserves the right to lengthen or shorten the model year for any product for any reason, or to start and end model years at different times. Some photos shown in this catalog may include optional equipment. Unless otherwise specified, all claims based on comparably equipped front-wheel drive sedans in the 2003 *Automotive News* mid-range standard segment and latest information available at time of printing. Level of equipment varies.

ENGINES

Grand Prix models are equipped with engines produced by different operating units of GM, its subsidiaries, or suppliers to GM worldwide.

THE ASSEMBLY OF GRAND PRIX

Grand Prix and its components are assembled or produced by different operating units of General Motors, its subsidiaries, or suppliers to GM worldwide. We sometimes find it necessary to produce Grand Prixes with different or differently sourced components than originally scheduled. Since some options may be unavailable when your vehicle is assembled, we suggest you verify that your vehicle includes the equipment you ordered or, if there are changes, that they are acceptable to you.

WARRANTY PROTECTION

Grand Prix's three-year/36,000-mile (whichever comes first) no-deductible bumper-to-bumper limited warranty covers repairs, including labor and parts, to correct any defects in material or workmanship occurring during the warranty period. The complete vehicle is covered, except for adjustments and normal maintenance.

CORROSION PROTECTION

Grand Prix is designed and built to resist corrosion. All body and sheet metal components are warranted against rust-through corrosion for six years or 100,000 miles, whichever comes first. Application of additional rust-inhibiting materials is not required under the corrosion coverage and none is recommended. See your Pontiac dealer for terms of these limited warranties.

UPDATED SERVICE INFORMATION

Pontiac regularly sends its dealers useful service bulletins about Pontiac products. Pontiac monitors product performance in this field. We then prepare bulletins for servicing our products better. Now you can get these bulletins too. Ask your dealer.

UPROMISE

GM is proud to be the only car company that can help you save for college with Upromise—for you, your children, your grandchildren, or any child you care about. GM has teamed up with Upromise, a free service that can help you turn your everyday spending with hundreds of America's leading companies into college savings. Once you join Upromise for free, every time you use your credit card, make a long distance phone call, shop online, buy gas, dine out—even buy an eligible new GM car or truck—you can get a portion of your purchase back as college savings. It's free to join, and takes just minutes. Learn more and join for free today at upromise.com/gmcatalog.



ROADSIDE SERVICE

Pontiac backs every 2004 Grand Prix with an extensive three-year/36,000-mile bumper-to-bumper limited warranty (whichever comes first), free courtesy transportation, and 24-hour roadside assistance that provides free lockout assistance, free dead-battery assistance, free out-of-fuel assistance, free flat-tire change, and free towing for warranty repairs in an emergency. Roadside assistance membership is free, however some services may incur costs.

A NOTE ABOUT CHILD SAFETY

Always use safety belts and proper child restraints, even in vehicles equipped with air bags. Children are safer when properly secured in a rear seat. Never place a rear-facing infant restraint in the front seat of any vehicle equipped with an active air bag. See your vehicle Owner's Manual and child safety seat instructions for more information. Pontiac supports the National SAFE KIDS Campaign,® a grassroots program dedicated to reducing unintentional childhood injuries.



ENHANCE YOUR OWNERSHIP EXPERIENCE

The Owner Center at MyGMLink is a free online service that helps you make the most of your vehicle ownership.

- Sign up for e-mail reminders about service visits
- Keep an online history of services performed
- Read your Owner's Manual, warranty, and more online
- Receive only the recall notices that apply to your vehicle
- Watch do-it-yourself videos and much more



Register today at MYGMLink.com!

For more information on Grand Prix, visit pontiac.com/grandprix or call the Pontiac Customer Assistance Center at 1-800-2 PONTIAC.

GENERAL MOTORS, THE GM EMBLEM, PONTIAC, THE PONTIAC LOGO, GRAND PRIX, STABILITRAK, DELCO, and GTP are registered trademarks of General Motors Corporation. TAPSHIFT and WIDETRACK are trademarks of General Motors Corporation. THEFTLOCK, ETR, MAGNASTEER, FREEDOM, and PASS-Key are registered trademarks of Delphi Technologies, Inc. ONSTAR, THE ONSTAR EMBLEM, and ONSTAR BUTTON are registered trademarks of OnStar Corporation.

©2003 GENERAL MOTORS CORPORATION. ALL RIGHTS RESERVED. LITHO IN USA, MARCH 2003.





PONTIAC

Fuel for the Soul

pontiac.com/grandprix