



A3

Audi A3

Truth in Engineering **Audi** 

Turning love at first sight into a true connection.

Your Audi A3 definitely knows how to make a first impression. Just consider its strong, athletic lines and that unmistakable Audi Singleframe® grille. But to turn love at first sight into more than just a momentary reaction, one has to dig a little deeper. Do this, and what you'll uncover is much more than what first captivates the eye. The trademark available Audi quattro® all-wheel drive system is ready to help maximize traction, while an optional TDI® clean diesel engine helps give you unmatched fuel efficiency¹ without compromising performance. You'll also discover a wealth of available innovative technologies, like Audi Navigation plus² with traffic information, that helps keep you effortlessly connected to the world. So go ahead, take some time to reflect. We promise that what you'll feel is much more than a schoolyard crush.

.01 - Audi S line® Exterior Appearance

Displaying an even more aggressive side of the A3, the S line exterior gives the vehicle a sportier appearance with aerodynamic front and rear bumpers, rear roof spoiler and distinct Audi S line badges.



¹ 30 city/42 highway mpg (2013 Audi A3 2.0 TDI® with Audi S tronic® dual-clutch transmission and front-wheel drive). EPA estimates. Your mileage will vary. ² See Infotainment/Technology section of the Featured Content page for important information regarding Audi Navigation plus.

2013 Audi A3 Premium plus shown in Ibis White with available 18" Sport package and optional Open Sky panoramic sunroof.



.02 - LED Daytime Running Light Technology - fig. 01

Stylish and iconic, available LED daytime running lights help enhance the unmistakable look and design of the Audi A3 as well as its visibility to other drivers, especially during the dawn and dusk hours.

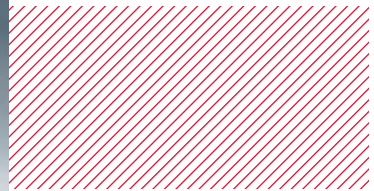

Space fit for a modern family, and their best friend. With room to comfortably fit five, the A3 ensures nobody has to be left out of the fun.

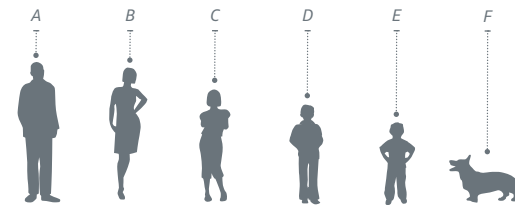

- fig. 02

If this design could speak, it would speak volumes.

Its exterior may appear to talk a big game, but it's the inside that, if it could speak, would really speak volumes. The luxurious interior is spacious enough for you to bring almost anything your next excursion may require, while your four passengers will thank you after experiencing the supple standard leather that graces every seat. In here, the possibilities are exceptionally outspoken.

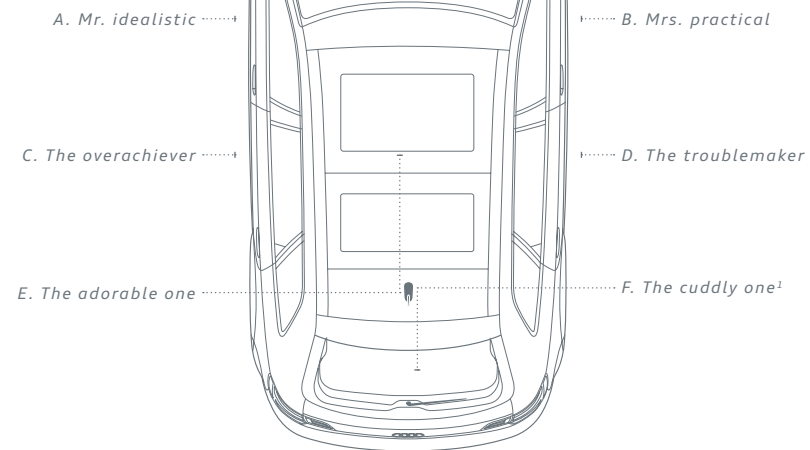

Luxury should always offer a new perspective.



2013 Audi A3 shown in Black leather with available 18" Sport package.

.03 - Leather Seating Surfaces

Naturally, this being an Audi, all the seating surfaces are wrapped in leather and feature beautiful stitching to complement the artistic design.



.04 - Dual-zone Automatic Climate Control

Who says you have to compromise on your personal comfort? Dual-zone automatic climate control gives you and your front passenger the ability to independently maintain your perfect temperature.

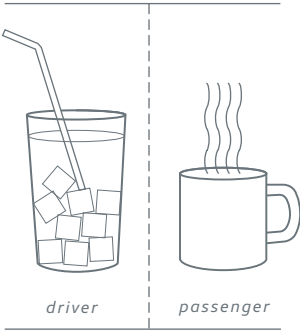

Experience an interior that hits all the right notes. The vents, switches and center console offer a fresh and modern look, while the distinctive instrument panel features white-on-black gauges with red needles for quick and accurate readings. Add to that supple leather seating surfaces and quality inlay materials, and *sophisticated, refined* and *purposeful* are three words that truly go the distance in here.



.05 - Flexmetallic Trim

Along with the ergonomic design of the door handles, flexmetallic trim graces the beltline to add to the overall bold and contemporary feel of the interior.

In here, the possibilities shine brighter.

In the A3, it's all about what you can do, not what you can't. That's why it has an exceptionally versatile interior. Throw in an available Open Sky panoramic sunroof destined to make every day brighter. Now what do you have? An interior that is capable of turning your every whim into reality.



UVA/UVB Protection

.06 - Open Sky Panoramic Sunroof

Let it all in with the available Open Sky panoramic sunroof. It creates a refreshing and light-filled interior that further adds to the pleasing ambience. And to keep you and the luxurious interior protected, the glass blocks UVA and UVB rays.

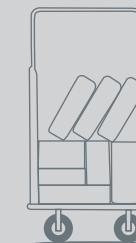

.07 - Spacious Cargo Area

Just try to fill it up. With 60/40 split folding rear seats that allow for multiple configurations and a maximum cargo capacity of 39 cu ft, there's no denying its cargo-carrying abilities.

Your world, right where it should be.

You should expect nothing less from Audi. And after experiencing all the ways we keep you connected, your expectations will be even greater. With available features like the advanced Audi music interface that provides intelligent integration with your iPod®, Audi Navigation plus with traffic information, and seamlessly integrated BLUETOOTH® technology, you'll quickly realize we are all about keeping you infinitely connected to your world.¹



.08 - BOSE® Sound System

Satisfying sound requires a premium delivery system. And no company is more synonymous with high-quality sound than BOSE®. Tailored to work with the interior space of the A3, the available BOSE® sound system lets you experience music the way it was intended.



+ +

38° 57' 8.1" N

77° 23' 41.1" W



33° 46' 03.1" N

118° 11' 26.5" W



.09 - Audi Navigation Plus

The intuitive Audi Navigation plus is available to help ensure you'll be able to quickly input your next destination. And with the Audi real-time traffic feature, you can bet you'll get there without the gridlock!

.10 - BLUETOOTH® Technology

Staying connected has never been more important. That's why your A3 features available BLUETOOTH® mobile phone connectivity for simple, hands-free functionality. With a simple push of a button on the steering wheel you can make and receive calls!

.11 - SiriusXM Satellite Radio

Go ahead. Crisscross the country. We assure you, you'll never run out of entertainment options, with over 130 channels of music, talk and news!

.12 - Audi Audio

Now you're in control. The available Audi music interface helps give you seamless iPod® integration. Your iPod® can be controlled through the audio system and steering controls, and with two standard SD card slots for your MP3 music, your entertainment options just keep getting better.



¹ See Infotainment/Technology section of the Featured Content page for important information regarding Audi Navigation plus, BLUETOOTH® and required SiriusXM subscriptions.

quattro

It's a bond between your car and the road.

It's true that while the available Audi quattro® all-wheel drive may have been engineered to help drive through inclement weather and in low-traction situations, the real magic of this advanced system is how it performs in the dry. Power is distributed to all four wheels working in concert to help grip every corner while giving you the optimal amount of power delivery where and when it's needed. In other words, quattro® helps enhance performance by appropriately transferring power to the necessary wheels when accelerating and turning, so you have confidence-inspiring performance when the road isn't at its best. Inclement weather aside, the really gripping story about quattro® is how it performs overall, forging a sure bond between you, your Audi A3 and the road.¹

Confidence-inspiring

Under ideal conditions, power is 85:15 front-wheel-biased to help maximize efficiency, but the instant conditions become more challenging, the ratio is optimized for superior grip and control.

Center differential

During normal driving conditions, the center differential transfers more power to the front wheels, but in extreme circumstances it can transfer all the torque to one of the two axles, helping to give you optimal traction.

Sport suspension

Ensuring poise in every turn, you can count on the available sport MacPherson strut front suspension and multilink rear suspension to provide a high level of lateral rigidity. So whether you're dodging traffic in the city or taming an apex-filled mountain road, you can expect dynamic handling.

¹ When driving during cold, rainy, snowy or icy weather conditions, ensure that your vehicle is equipped with appropriate all-season or winter-weather tires. Even with appropriate tires, you must always drive in a manner appropriate for the weather, visibility and road conditions.

The hard part is making it look easy.

Typically, the more effortless something seems, the more difficult it is to do. Case in point: the Audi 2.0 TFSI® engine. Producing seamless power and punchy torque may seem easy, but peel back the mechanical layers and you'll find an array of technologically ingenious features that help make the creation of power a far more impressive feat.

.13 - 2.0 TFSI Engine

Years ahead of the competition, this 2.0-liter turbocharged DOHC engine combines the Audi valvelift system, variable valve timing, TFSI direct injection and turbocharging for more power and greater efficiency.¹

.14 - Audi Valvelift System



Elevating the performance of your A3, the Audi valvelift system intelligently varies the lift and duration of the engine's exhaust valves, helping deliver smooth power buildup, instantaneous throttle response and a reduction in fuel consumption.¹

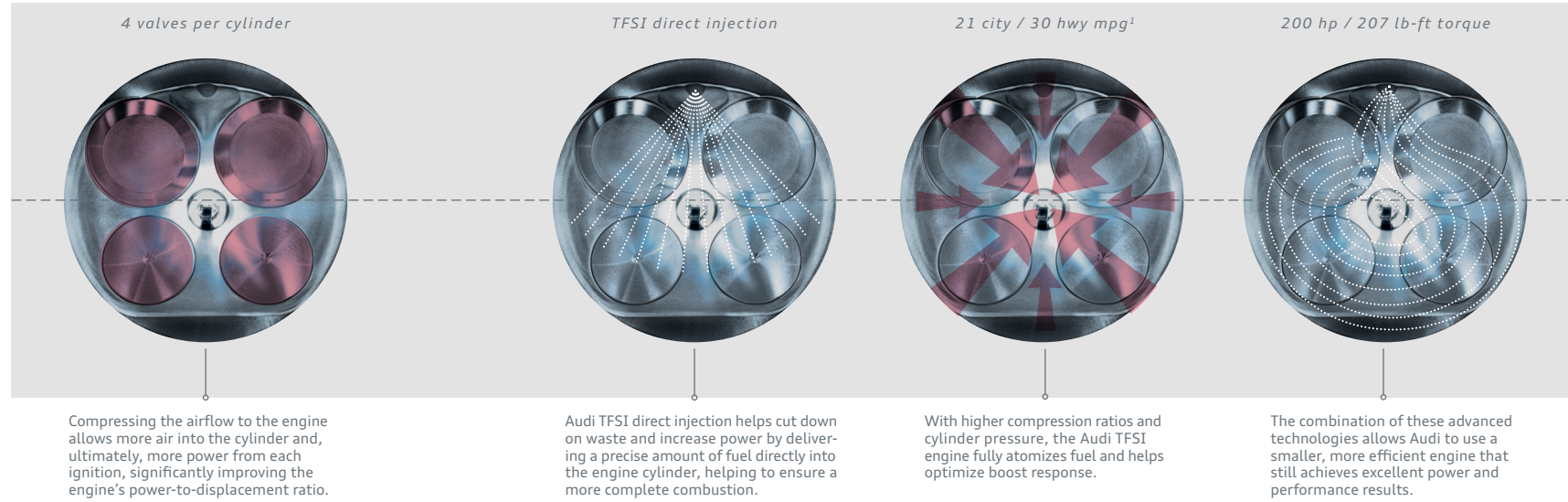

.15 - Six-speed Manual Transmission

For drivers who crave engaging and dynamic response, the Audi A3 presents an available six-speed manual gearbox that delivers power with vintage Audi finesse. Its short throw and precise ratios add a contemporary element for confident performance on the road.

Shifting in 0.2 seconds requires a completely new way of doing things. Utilizing two clutches, the Audi S tronic® transmission facilitates lightning-quick gear shifts and near-constant power by ensuring you are in the gear you select the instant you select it. With almost no loss of momentum, no loss of rpm and almost no lag between gears, S tronic delivers a thrilling experience.

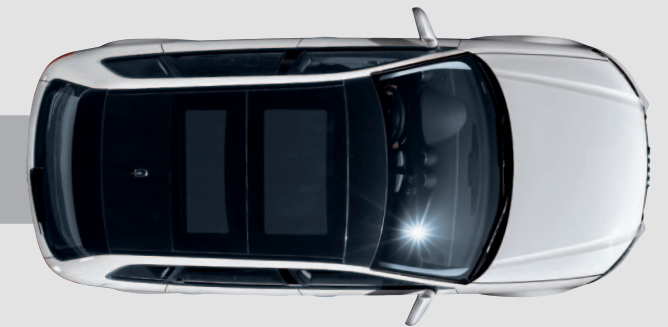
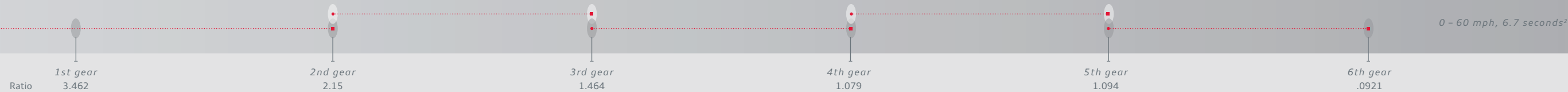

¹ 21 city/30 highway mpg (2013 Audi A3 2.0T, with six-speed manual transmission and front-wheel drive). EPA estimates. Your mileage will vary. ² 0-60-mph times will differ from model to model.

TDI Clean Diesel

Be the one to say “Less filling!” and mean it.

In the realm of high efficiency, all fuels are not created equal—or engines, for that matter. Consider the Audi TDI® clean diesel engine, which achieves better fuel economy than a comparable gasoline engine while producing less CO₂ emissions.¹ And when you add in the thrilling off-the-line acceleration that its 140 hp and 236 lb-ft of torque provide, you’ll have an even better reason to yell out loud.²



- fig. 03

.16 - The Difference in Diesel

When it comes to diesel, density is destiny. By having greater density than gasoline, diesel packs more energy content in the same amount of fuel, which helps maximize the miles per gallon when that energy is released during a more powerful combustion.¹

.17 - Why It's Good to Combust

Combustion is, of course, how fuel is transformed into power. What makes diesel combustion most impressive is how it is more efficiently consumed by your TDI® clean diesel engine. Innovative, advanced direct injection technology makes the A3 TDI® clean diesel very responsive to the throttle, yet more fuel-efficient and emissions-low in output.¹

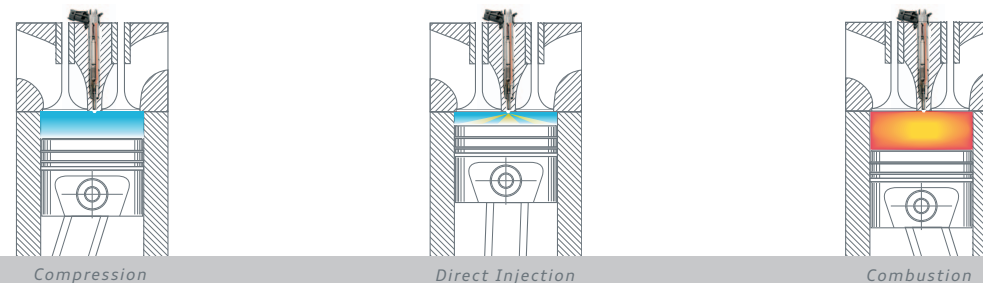

- fig. 04

Compression
A significantly higher compression ratio and cylinder pressure in the combustion chamber means fuel is fully atomized. The advantage is optimized turbocharger boost and fuel efficiency.

Direct Injection
The high-pressure direct injection is an important part of the TDI® engine's remarkable horsepower and torque. By mixing the precise amount of fuel and air in the chamber, maximum combustion and maximum power are achieved.

Combustion
Combining the high compression ratio with direct injection allows for a more thorough combustion, helping ensure a highly efficient and lower-emission process.

Illustrations do not reflect actual operation and are for explanatory purposes only.

.18 - Engineered for More Torque

Audi uses a classic technological principle—leverage—to help deliver more torque. With TDI® clean diesel engines, the piston travels farther through a deeper crankshaft throw, while a longer connecting rod acts as the fulcrum, helping produce more lb-ft of torque via the long stroke. And you feel the end result in the way your A3 accelerates, with a powerful burst of torque-driven response.

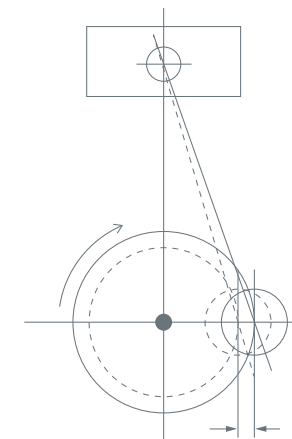

- fig. 05

2013 Audi A3 2.0 TDI® Premium plus shown in Ibis White with optional Open Sky panoramic sunroof.

¹ 30 city/42 highway mpg (2013 Audi A3 2.0 TDI®, with Audi S tronic® dual-clutch transmission and front-wheel drive); 21 city/30 highway mpg (2013 Audi A3 2.0T, with six-speed manual transmission and front-wheel drive); EPA estimates. Your mileage will vary. ² Obey all speed and traffic laws.

We'll own up to being control freaks.

Some might see that as a problem, but to us it's just another way of saying we care. You see, we kind of have a thing for safety. Namely, yours. That's why we go out of our way to help you in the event of a collision—and why we developed such a wide array of innovative structural safety features. So if the unthinkable does happen, you can rest easier knowing we've put in a solid and comprehensive last line of defense.

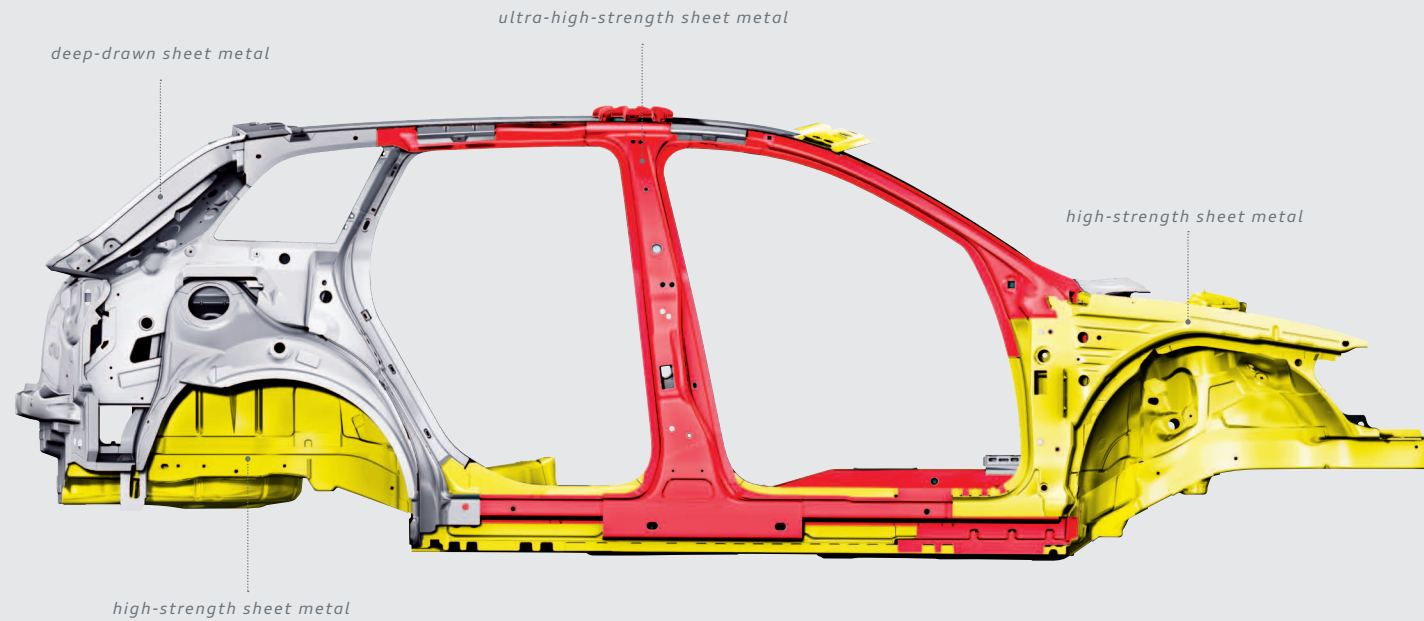

.19 - Safety Shell

The body of the A3 uses a unique combination of ultra-high-strength and high-strength sheet metal that makes for a highly rigid and crash-optimized occupant shell. And by using state-of-the-art calculation and simulation methods, and new materials and joining techniques, it was possible to increase body rigidity and help enhance crash performance.

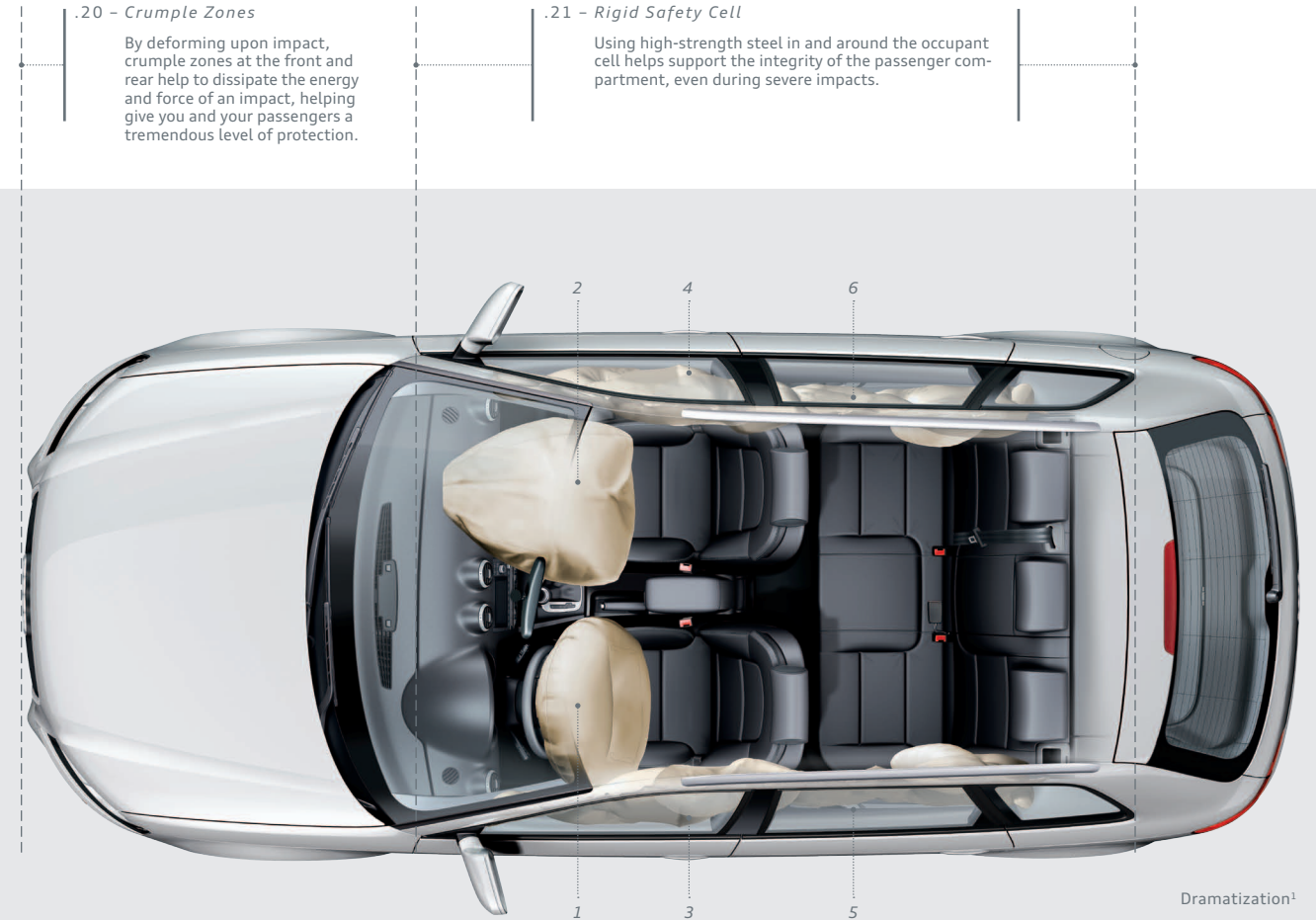

.22 - Six Standard Airbags

Helping provide an additional level of protection are six standard second-generation airbags. These include front-impact airbags for the driver and front passenger, designed to aid in protection of the head; seat-mounted thorax side airbags, engineered specifically to help protect the thorax; and Sideguard® head curtain airbags developed to offer front and rear outboard occupants some head protection in the event of a side collision or rollover. And for added protection, rear-passenger thorax side airbags are available, for a possible airbag total of eight.²

¹ This is a dramatization and does not depict what will happen in a collision. All bags will not inflate in real-world collisions, and, if multiple bags do deploy, they will be in various stages of inflating/deflating and will never all be inflated at the same time. ² Airbags are supplemental restraints only and will not deploy under all crash circumstances. Always use safety belts and seat children only in the rear, using restraint systems appropriate for their size and age.



2013 Audi A3 2.0T Premium plus shown in Ice Silver metallic with available 18" Sport package and optional Open Sky panoramic sunroof.



.23 - LED Taillight Technology



- fig. 06

Signature LED light pipe technology gives your A3 an unmistakably Audi look, while helping to increase its visibility to other drivers in adverse conditions.

Leave them with more than just a passing memory.

It should come as no surprise that when first greeted by the Audi A3, its sleek, flowing lines do their fair share to mesmerize. But when you consider its other attributes, it becomes even more evident why this vehicle always leaves onlookers pining for more. From its distinct and brilliant LED taillights to the perfectly placed, side-by-side dual chrome exhaust outlets, if you have to say goodbye to someone, why not say it in a way they'll never forget?



Colors

Interior Colors | Seat Selections

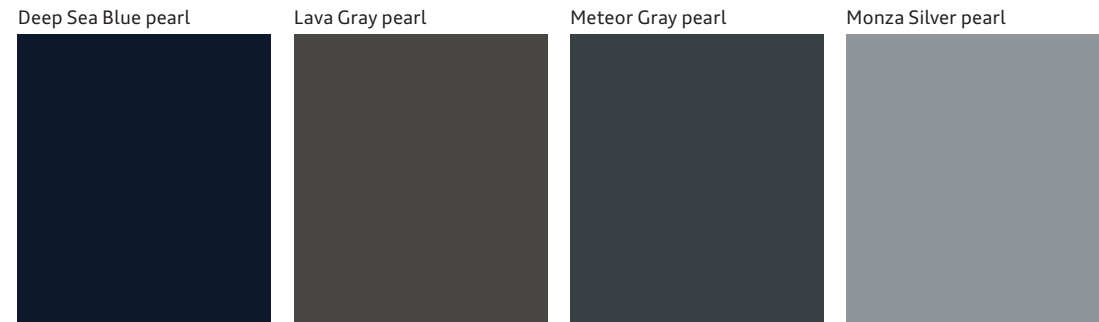
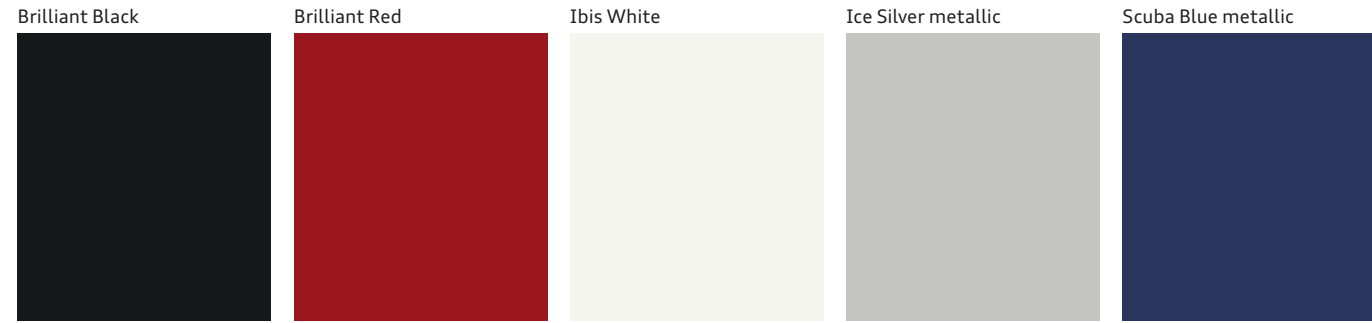

Standard Seat

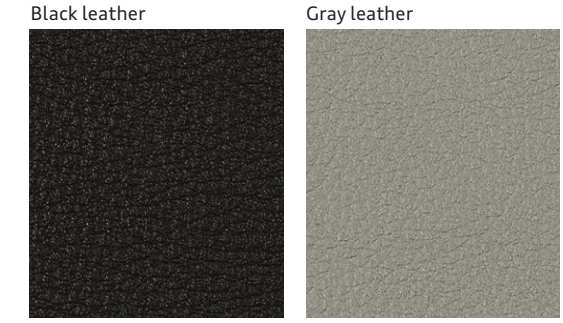

Sport Seat

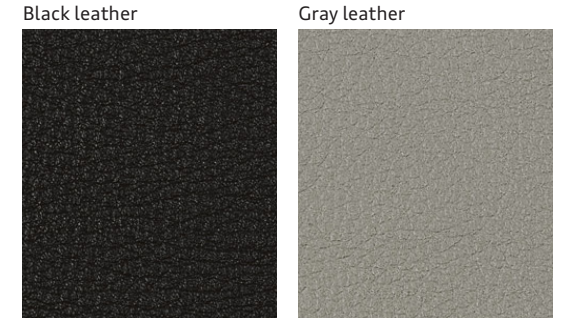

Titanium Sport package



Decorative Inlays



Flexmetallic inlay¹

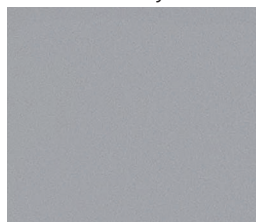

Aluminum Medial inlay¹

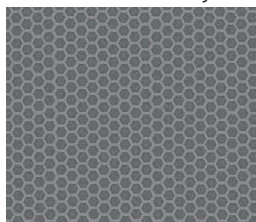

Dark Brown
Walnut Wood inlay¹

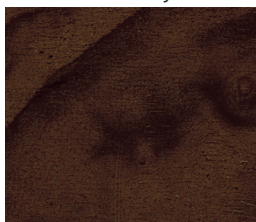

Piano Black inlay¹

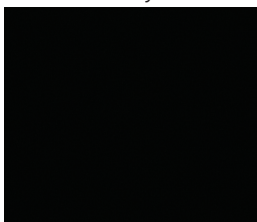

Titanium Sport package

Wheels

17" 5-split-spoke design
225/45 all-season tires



Premium

17" 10-spoke design
225/45 all-season tires



Premium plus

18" 5-segment-spoke design
225/40 summer performance tires²



18" Sport package

18" 5-arm-rotor design, titanium finish
225/40 summer performance tires²



Titanium Sport package

¹ Decorative inlay options will vary based on model and interior color combination. See your dealer for details.

² Tires are supplied and warranted by their manufacturer. High-performance tires are designed for optimum performance and handling in warm climates. They are not suitable for cold, snowy, or icy weather conditions. If you drive under those circumstances, you should equip your vehicle with all-season or winter tires, which offer better traction under those conditions. We suggest you use the recommended winter or all-season tire specified for your car or its equivalent. These high-performance tires also have a lower aspect ratio that aids performance and handling; however, in order to avoid tire, rim or vehicle damage, it is important that the inflation pressure is regularly checked and maintained at optimum levels. Please also remember in making your selection that, while these tires deliver responsive handling, they may ride less comfortably and make more noise than other choices. Finally, these tires may wear more quickly than other choices.

Technical Specifications

Engineering Performance	A3 2.0T	A3 2.0 TDI®
Engine type	Four-cylinder	Four-cylinder
Engine block/Cylinder head	Cast-iron/Aluminum-alloy	Cast-iron/Aluminum-alloy
Displacement (cc)/Bore and stroke (mm)	1,984/82.5 x 92.8	1,968/81 x 95.5
Horsepower @ rpm	200 @ 5,100	140 @ 4,200
Torque (lb-ft @ rpm)	207 @ 1,800	236 @ 1,750
Compression ratio	9.6:1	16.5:1
Valvetrain	16-valve DOHC with valvelift system	16-valve DOHC
Induction/Fuel injection	Turbocharged/TFSI®	Turbocharged/TDI®
Acceleration with six-speed manual transmission with front-wheel drive (0–60 mph) ¹	7.1 seconds	—
Acceleration with Audi S tronic® transmission with front-wheel drive (0–60 mph) ¹	6.9 seconds	8.9 seconds
Acceleration with Audi S tronic® transmission with Audi quattro® all-wheel drive (0–60 mph) ¹	6.7 seconds	—
Top track speed ¹	130 mph	130 mph

Transmission | Drivetrain

Six-speed manual transmission with front-wheel drive <p>(Gear ratios: 1st: 3.357, 2nd: 2.087, 3rd: 1.469, 4th: 1.098, 5th: 1.108, 6th: 0.927, Reverse: 3.990, Final Drive: 3.944 [1st-4th] and 3.087 [5th, 6th, Reverse])</p>	Available	—
Six-speed Audi S tronic® dual-clutch transmission with front-wheel drive <p>(Gear ratios: 1st: 3.462, 2nd: 2.150, 3rd: 1.464, 4th: 1.079, 5th: 1.094, 6th: 0.921, Reverse: 3.989, Final Drive: 4.059 [1st-4th] and 3.136 [5th, 6th, Reverse])</p>	Available	—
Six-speed Audi S tronic® dual-clutch transmission with front-wheel drive <p>(Gear ratios: 1st: 3.462, 2nd: 2.050, 3rd: 1.300, 4th: 0.902, 5th: 0.914, 6th: 0.756, Reverse: 3.989, Final Drive: 3.043)</p>	—	■
Six-speed Audi S tronic® dual-clutch transmission with Audi quattro® all-wheel drive <p>(Gear ratios: 1st: 3.462, 2nd: 2.150, 3rd: 1.464, 4th: 1.079, 5th: 1.094, 6th: 0.921, Reverse: 3.989, Final Drive: 4.059 [1st-4th] and 3.136 [5th, 6th, Reverse])</p>	Available	—

Body | Suspension | Chassis

Fully galvanized steel unibody with multistep anti-corrosion protection	■	■
MacPherson strut front suspension with stabilizer bar	■	■
Four-link rear suspension with stabilizer bar	■	■
Sport suspension calibration	SP/TP	SP/TP
Audi servotronic® speed-sensitive power steering—varies assistance based on vehicle speed	■	■

■ Standard	BP BLUETOOTH® Value package	CP Convenience package	CW Cold Weather package
— Not applicable	NV Audi Navigation plus package	SP 18" Sport package	TP Titanium Sport package

Exterior measurements	A3 2.0T	A3 2.0 TDI®
Wheelbase (in)	101.5	101.5
Length (in)	169	169
Height (in)	56.02	56.02
Overall width with mirrors (in)	78.54	78.54
Overall width without mirrors (in)	69.48	69.48
Track (in, front/rear)	60.3/59.3	60.3/59.3
Curb weight with six-speed manual and front-wheel drive (lb)	3,219	—
Curb weight with Audi S tronic® transmission and front-wheel drive (lb)	3,296	3,318
Curb weight with Audi S tronic® transmission and quattro® all-wheel drive (lb)	3,461	—
Drag coefficient (Cw)	0.33	0.33

Interior measurements

Head room (in, front/rear)	39.3/36.9	39.3/36.9
Leg room (in, front/rear)	41.2/34.8	41.2/34.8
Shoulder room (in, front/rear)	54.4/52.8	54.4/52.8
Cargo volume (cu ft, std/rear seat folded)	19.5/39.0	19.5/39.0
Passenger volume (cu ft)	89	89
Seating capacity	5	5

EPA mileage estimates | Capacities

Manual transmission with front-wheel drive (city/highway/combined) ²	21/30/24	—
Audi S tronic® transmission with front-wheel drive (city/highway/combined) ²	22/28/24	30/42/34
Audi S tronic® transmission with quattro® all-wheel drive (city/highway/combined) ²	21/28/24	—
Engine oil (qt)	4.9	4.2
Coolant system (qt)	9.1	9.2
Fuel (gal, front-wheel drive/quattro®)	14.5/15.8	14.6/—
Required fuel	Premium	Ultra-low-sulfur diesel

^[1] Top track speed is electronically limited in the U.S. Obey all speed and traffic laws.

^[2] EPA estimates. Your mileage will vary.

Featured Content

Safety Security	Premium	Premium plus
Driver and front passenger dual-stage airbags, thorax side airbags and Sideguard® head curtain airbags ¹	■	■
Rear-passenger thorax side airbags ¹	Optional	Optional
Front passenger occupant detection—for airbags ¹	■	■
Safety belt reminder for driver and front passenger	■	■
Lower Anchors and Tethers for CHildren (LATCH) in rear seats	■	■
Power central locking system with safety unlock feature if airbags deploy	■	■
Electronic Stability Control (ESC) with traction control (ASR)	■	■
Anti-lock Brake System (ABS) with Electronic Brake-pressure Distribution (EBD) and brake assist	■	■
Tire-pressure monitoring system	■	■
Hill hold assist	■	■
Anti-theft alarm system with panic function	■	■

Exterior	Premium	Premium plus
Audi Singleframe® grille	■	■
Halogen headlights with daytime running lights	■	—
Xenon plus headlights with LED daytime running light technology	—	■
Automatic headlights	—	CP
Front fog lights	■	■
LED taillight technology	■	■
Power-adjustable exterior side mirrors	■	■
Power-adjustable heated exterior side mirrors	CW	CW
LED turn indicator light technology integrated into the exterior side mirrors	■	■
Heated windshield washer nozzles	CW	CW
Single exhaust outlet on driver's side (2.0 TDI®)	■	■
Dual exhaust outlets on driver's side (2.0T)	■	■
Audi S line® exterior appearance	■	■
Aluminum roof rails	Optional	Optional
Black roof rails	—	Optional with TP

■ Standard

— Not applicable

BP BLUETOOTH® Value package

NV Audi Navigation plus package

CP Convenience package

SP 18" Sport package

CW Cold Weather package

TP Titanium Sport package

Interior	Premium	Premium plus
Dual-zone automatic climate control	■	■
Four-spoke steering wheel	■	—
Four-spoke multifunction steering wheel	BP	—
Three-spoke multifunction sport steering wheel	—	■
Shift paddles (Audi S tronic® transmission)	—	Optional
Tilt and telescopic manually adjustable steering column	■	■
Decorative interior inlays (see Decorative Inlays page for more details) ²	■	■
LED interior ambient lighting technology	—	■
Two front beverage holders	■	■
Two power outlets	■	■
Folding front center armrest	■	■
Black cloth headliner	—	TP
Auto-dimming rear view mirror with compass	—	CP
Dual front sun visors with vanity mirrors	■	—
Dual front sun visors with lighted vanity mirrors	—	■
Power windows with one-touch up/down operation and pinch protection	■	■
Open Sky panoramic sunroof	—	Optional

Seating	Premium	Premium plus
Leather seating surfaces (see Interior Colors page for more detail)	■	■
Leather/Alcantara® seating surfaces (see Interior Colors page for more detail)	—	TP
Six-way manual driver seat	■	—
Six-way manual front passenger seat	■	■
Eight-way power driver's seat with four-way power lumbar adjustment	BP	■
Sport front seats	SP	SP/TP
Heated front seats	CW	CW
Split folding 60/40 rear seatback	■	■

¹ Airbags are supplemental restraints only and will not deploy under all crash circumstances. Always use safety belts and seat children only in the rear, using restraint systems appropriate for their size and age. ² Decorative inlay options will vary based on model and interior color combination. See your dealer for details.

Featured Content

Infotainment | Technology

	Premium	Premium plus
Audi Navigation plus with traffic information ¹	—	NV
Driver information system with trip computer	■	■
Audi concert radio with ten speakers and single CD player with MP3 playback capability	■	■
BOSE® sound system with ten speakers and AudioPilot® noise-compensation	—	CP
SiriusXM Satellite Radio with 90-day trial subscription ²	■	■
Audi music interface with iPod® integration (not available with six-disc CD changer)	—	NV
Six-disc CD changer (not available with Audi music interface)	—	NV
BLUETOOTH® wireless technology preparation for mobile phone	BP	■
Cruise control with coast, resume and accelerate features	■	■
Parking system with rear sensors	—	CP
Rain/light sensor for automatic windshield wipers and headlights	—	CP

■ Standard
— Not applicable

BP BLUETOOTH® Value package
NV Audi Navigation plus package

CP Convenience package
SP 18" Sport package

CW Cold Weather package
TP Titanium Sport package

¹ Audi Navigation plus depends on signals from the worldwide Global Positioning Satellite network. The vehicle's electrical system and existing wireless and satellite technologies must be available and operating properly for the system to function. The system is designed to provide you with suggested routes in locating addresses, destinations and other points of interest. Changes in street names, construction zones, traffic flow, points of interest and other road system changes are beyond the control of Audi of America, Inc. Complete detailed mapping of lanes, roads, streets, toll roads, highways, etc., is not possible, therefore you may encounter discrepancies between the mapping and your actual location. Please rely on your individual judgment in determining whether or not to follow a suggested Audi Navigation plus route. Periodically mapping updates will be available for purchase at an additional cost. Consult your dealer or call 1-800-FOR-AUDI for details. ² SiriusXM Satellite Radio subscriptions sold separately or as a package after trial expires. Subscriptions are governed by SiriusXM Customer Agreement (see www.siriusxm.com) and are continuous until you call SiriusXM to cancel. Sirius U.S. Satellite Service available only to those 18 and older in the 48 contiguous U.S.A., D.C and Puerto Rico (with coverage limitations).

Come dressed to kill, even if you're a pacifist.

Just driving an A3 is bound to turn heads, but when the Titanium Sport package is added into the mix, count on making those heads spin. The black-optic exterior appearance and 18" 5-arm-rotor design titanium-finish alloy wheels announce your arrival in memorable fashion, all while you indulge in the S line® embossed Black leather/perforated Alcantara® seating surfaces. And when you finish putting the sport-tuned suspension through its paces on that insanely twisty mountain road, sit back and take in the stunning Piano Black inlays and impressive Black cloth headliner.



2013 Audi A3 2.0T Premium plus shown in Ibis White with available Titanium Sport package and optional Open Sky panoramic sunroof.

Accessories

Imagine a cherry on top of your sundae. Sweet, right? Now imagine a cherry that helps protect your A3 in the garage. Or carries your bikes for a serious weekend on the trails. Or makes heads turn as you drive by. Audi Genuine Accessories are the little extras that make your Audi even sweeter. Designed by the same visionaries

who designed your vehicle, all accessories feature a tailored fit and the expert craftsmanship you'd expect from Audi. They are also backed by the 4-year/50,000-mile Audi New Vehicle Limited Warranty or the accessory's 12-month/12,000-mile limited warranty, whichever extends longer from the accessory purchase date.¹



18" Calera Wheels

This striking open-air design combines a bold Audi look with power in motion. Also available in an Audi wheel and tire package.

18" Castell Wheels

Experience the high-performance beauty of this multispoked design—the perfect addition to the A3.



Aluminum Bike Rack^{2,3}

This locking holder fits 20- to 80-mm bike frames with both wheels on the bike and helps keep the bike upright as you secure it in place.

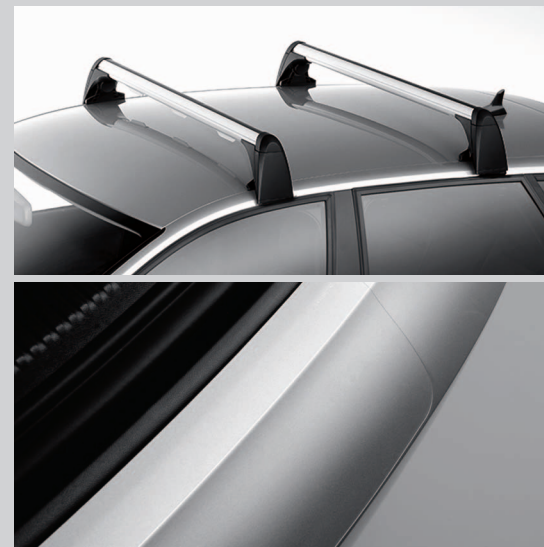

A3 Base Carrier Bars²

Attached to strong side brackets, these are the durable foundation of the Audi roof-rack system.

Load-protection Film

This custom-fit transparent film helps protect the rear bumper from scratches while loading and unloading. Outline depicts coverage area.



All-weather Trunk Liner

Custom fit for the A3. Textured material helps control load shifting. Raised lip helps contain spills and protect cargo-area carpeting from stains.

Parcel Shelf Organizer³

Extra storage always comes in handy. This efficient organizer delivers.



All-weather Floor Mats

Deep-ribbed, channeled design helps protect the floor and carpeting from water, mud, sand and snow. Rubber mats come in black and feature vehicle logo. Set of four (two front and two rear).

Valve Stem Covers

These handsome covers are made of polished stainless steel with a composite center cap. Emblazoned with the iconic Audi rings.

Other accessories not shown

Audi Genuine Sport and Design Accessories

Your Audi vehicle features a bold, aggressive stance and strong, stunning lines. Enhance it by adding Audi Genuine Sport and Design Accessories. All are carefully scrutinized in the design and development process. So while they're striking in appearance, they've also passed rigorous quality assessments, including corrosion testing. If you're looking for a bolder appearance or a finishing touch, there is a solution designed by Audi that makes every mile more enjoyable—and more yours.

Audi Genuine Alloy Wheels

Strike the perfect balance between breathtaking design and awe-inspiring performance with Audi Genuine Alloy Wheels. Audi experts have meticulously designed these wheels especially for each Audi model. They're engineered to the highest standards and endure rigorous testing to ensure long-term quality. Experience eye-catching style that is yours and yours alone. Nothing enhances the bold, dynamic look of your Audi vehicle faster.

Audi TravelSpace Transport Accessories

You go almost everywhere. Give your Audi the proper invitation to be part of your adventures. Never leave the necessary gear behind. Bring it with Audi TravelSpace Transport Accessories. The list includes bike racks, ski racks, a variety of watersports equipment carriers and various sizes of cargo carriers. Wherever you go, make sure almost everything fits with a variety of intelligent and innovative solutions. Accessories designed for your life—the passionate, active part.

Audi Genuine Electronics Accessories

The illuminating technology that graces each Audi vehicle provides the inspiration for Audi Genuine Electronics Accessories. Similarly, all of these accessories are impressively advanced and inspiring. Our audio options let you enhance your listening pleasure. Other accessory options help promote safe and convenient travel. All are designed and tested to help ensure compatibility with the vehicle's electrical systems, allowing you to enjoy every aspect of Audi technology with almost all your senses. Demand the best and drive with added confidence.

Audi Guard Comfort and Protection Accessories

Protect what you love. Audi Guard Comfort and Protection Accessories offer functional, practical items that help keep your Audi in pristine condition. Choose from such useful items as trunk liners that help make clean-up quick and easy, or an easy-to-use storage cover that helps shield the vehicle. Use them all to help reduce wear and tear and keep the vehicle looking like new—inside and out. All are engineered to stringent Audi standards, so you can be assured of their quality and durability.

¹ See dealer for details. ² All roof-rack system attachments require the base carrier bars. All attachments sold separately. ³ Recreational equipment, sporting equipment and luggage not included.

A3

2013 | A3

Audi of America
Audiusa.com
Facebook.com/Audi

Note: A word about this brochure. Audi of America, Inc., believes the specifications in this brochure to be correct at the time of printing. However, specifications, standard equipment, options, fabrics, and colors are subject to change without notice. Some equipment may be unavailable when your vehicle is built. Please ask your dealer for advice concerning current availability of standard and optional equipment, and your dealer will verify that your vehicle will include the equipment you ordered. Vehicles in this brochure are shown with optional equipment. See your dealer for complete details on the New Vehicle Limited Warranty, twelve-year limited warranty against corrosion perforation, and Audi 24/7 Roadside Assistance. (Roadside assistance coverage provided by Road America in the U.S. Certain conditions apply; see your dealer for details.) Tires supplied by various manufacturers. "Audi," all model names, "quattro," "Sideguard," "Singleframe" and the Singleframe grille design, "S line," "S tronic," "TFSI," "Truth in Engineering," and the four rings logo are trademarks or registered trademarks of AUDI AG. "Alcantara" is a registered trademark of Alcantara S.p.A. "BOSE" and "AudioPilot" are registered trademarks of the BOSE Corporation. The BLUE-TOOTH word mark and logos are owned by the Bluetooth SIG, Inc., and use of any such marks by AUDI AG is under license. "iPod" is a registered trademark of Apple, Inc. "Servotronic" is a registered trademark of the AM General Corporation. "SiriusXM" and all related marks and logos are trademarks of SiriusXM Radio Inc. and its subsidiaries. "TDI" is a registered trademark of Volkswagen AG. All other trademarks are the property of their respective owners. Some European models shown. Some features may not be available at time of order.