

Equipment Audi A3 Sedan/A3 Cabriolet/S3 Sedan

High-beam assist	99	Rear window, heated	122
Hold assist	124	Recuperation	98
Hood	86, 101	Remote control key	101
Hood compartment, variable	103	Reversible mat	103
Hood lining	121	Reversing camera	104
Illuminated vanity mirror	122	Safety steering column	123
Inlays	97	Seat belt reminder	123
Integrated head restraint system	103	Seat belts	123
Interior lighting	122	Seat heating, front	102
Interior mirror	103	Secondary collision brake assist	98
ISOFIX child seat mounting and Top Tether for the outer rear seats	103	Side airbags, front, and head airbag system	103
ISOFIX child seat mounting for the front-passenger seat	103	Side airbags, rear	123
Lashing points in the luggage compartment	123	Side impact protection	123
Leather steering wheel, 4-spoke design	100	Ski/snowboard bag	103
Leather upholstery and trim	93-95	S line	80-81
LED headlights	99	S line sport suspension	98
LED rear lights	99	Spare wheel, space-saving	119
Light/rain sensor	99	Sport leather steering wheel in 3-spoke design	100
Lighting package	100	Sport seats, front	91
Luggage compartment lid, automatically opening	101	Sport suspension	98
Manual air conditioning	101	S sport seats, front	91
Manual transmission	98	S sport suspension	73
MMI® navigation plus with MMI touch	107	Standard seats, front	90
MMI® radio	106	Start-stop system	98
Mobile phone/key holder	102	Steering wheel in 4-spoke design	100
Model/technology name	100	Storage and luggage compartment package	103
Multifunction leather steering wheel in 4-spoke design	100	Storage compartments	103
Multifunction sport leather steering wheel in 3-spoke design	100	S tronic®	98
Multifunction sport leather steering wheel in 3-spoke design, flattened at the bottom	100	Style guides	70-71
Navigation package	106	Sun visors	122
Paint finishes	86-87	Through-loading facility	103
Panoramic glass sunroof	101	Trailer towing hitch	103
Park assist with selective display	104	Tyre pressure loss indicator	119
Parking system, rear	104	Tyre repair kit	119
Parking system, rear	123	Variable headlight range control	99
Parking system plus with selective display	104	Vehicle jack	119
Progressive steering	98	Vehicle tool kit	119
Provision for trailer towing hitch quattro®	123	Ventilation system and heating	101
Rear lights	99	Warning and control lights	123
Rear seat backrest, folding	103	Warning triangle	123
		Wheels/tyres	88-89
		Wind deflector	101
		Windscreen cleaning system	122
		Xenon plus including headlight cleaning system	99

AUDI AG
85045 Ingolstadt
www.audi.com
Valid from September 2013

Printed in Germany
333/1230.30.24

The models and equipment versions illustrated and described in this brochure and some of the services listed are not available in all countries. Some of the cars illustrated are equipped with optional features for which an extra charge is made. Details concerning the delivery specifications, appearance, performance, dimensions and weights, fuel consumption and running costs of the vehicles were correct to the best of our knowledge at the time of going to press. Deviations from the colours and shapes shown in the illustrations may occur. No liability is accepted for errors and printing errors. The right to introduce modifications is reserved. Not to be reproduced, including in part, without the written approval of AUDI AG.

This catalogue is printed on paper made from pulp bleached without the use of chlorine.



Audi A3 Sedan | A3 Cabriolet | S3 Sedan

A3

Audi A3 Sedan | A3 Cabriolet
Audi S3 Sedan

Vorsprung durch Technik



Responsibility

Living up to our responsibilities is a principle that is firmly anchored in the Audi strategy. Alongside commercial success and international competitiveness, our responsibility toward company employees and society as a whole is a key consideration, as is protecting the environment and conserving resources. And what is true in the details – our catalogues are printed on FSC-certified paper – also holds in general: Audi develops cars that are not only sporty and emotive but also ever more efficient. In the long run, Audi wants its products

to allow CO₂-neutral mobility. Seeing to it that production in Audi plants gradually becomes CO₂-neutral is another aspect of our comprehensive approach. Audi is also committed to society – particularly in the fields of education, technology and social projects. At Audi, sustainability is closely linked with how we see the future: the Audi Urban Future Initiative sees Audi working with international experts to get to the root of future urban challenges and trends in mobility.

the world of Audi.



Choosing an Audi means choosing a brand that offers more. More individuality. More exclusivity. More fascination.



Team spirit

Motorsport is a driving force behind the brand. For years Audi has been among the champions in various racing series, for instance the 24 Hours of Le Mans or the DTM German Touring Car Masters. The values that are crucial in many different areas of sport are also central ones for Audi: precision, passion and technology. No coincidence then that Audi has been sponsoring sporting events for

many years. In the world of winter sports, for example, Audi has been the main sponsor of the German Ski Association (DSV) for almost three decades and has also partnered 14 other national alpine ski teams. In football, we support national and international teams. And Audi is also a partner for the German Olympic Sports Confederation.

www.audi.com

Information on all the topics mentioned above can be found on our website: www.audi.com.



www.audi.com



configurator.audi.com



www.audi.com/vorsprung-durch-technik



www.audi.com/driving



www.audi.com/cr

Equipment Audi A3 Sedan/A3 Cabriolet/S3 Sedan

12V socket		Brake callipers	73
in the front centre console	123	Brake system with disc brakes	
4-way lumbar support		front and rear	121
for the front seats	101	Camera-based recognition of traffic signs	105
Acoustic hood	101	Centre armrest, front	102
Acoustic windscreen	101	Centre console with storage compartment	123
Active roll-over protection	103	Cigarette lighter and ashtray	102
Adapter cable set for Audi music interface	106	Cloth/leather upholstery and trim	93, 95
Adapter cable set plus		Cloth upholstery and trim	92, 95
for Audi music interface	106	Connectivity package	108
adaptive brake light	99	Convenience entry	101
adaptive cruise control including		Convenience key	101
Audi pre sense front	105	Cruise control system	104
adaptive light	99	Dark-tinted windows (privacy glazing)	101
Airbags	103	Deluxe automatic air conditioning	102
Aluminium-look exterior	100	Diesel particulate filter, additive-free	98
Aluminium-look interior	100	Digital Audio Broadcasting	106
Anti-Slip Regulation (ASR)	124	Door sill trims	73, 76-81
Anti-theft alarm	103	Driver information system	105
Anti-theft wheel bolts	119	Driver information system	
Assistance package	105	with colour display	105
Audi active lane assist	104	Driver seat, electrically adjustable	101
Audi connect	107	Dynamic suspension	98
Audi cylinder on demand	98	Electromechanical parking brake	98
Audi design selection lasso brown	82, 95	Electromechanical power steering	98
Audi design selection parade red	83, 95	Electronic Differential Lock (EDL)	124
Audi drive select	98	Electronic immobiliser	123
Audi exclusive	84-85	Electronic Stabilisation Control (ESC)	124
Audi exclusive aluminium		Electronic Stabilisation Control (ESC)	
gear lever knob	101	with electronic axle-differential lock	124
Audi exclusive leather controls	101	Equipment lines	76-79
Audi exclusive leather steering wheel rim	101	Exhaust tailpipes	73, 100
Audi Extended Warranty	108	Exterior mirrors	103
Audi Genuine Accessories	110-111	First-aid kit	123
Audi magnetic ride	98	Fitting for Tracking Assistant	123
Audi music interface	106	Floor mats, front	123
Audi phone box	108	Front-passenger seat, height-adjustable	101
Audi pre sense basic	104	Front-wheel drive	98
Audi pre sense front	104	Front fog lights	99
Audi radio	105	Front seats, electrically adjustable	101
Audi side assist	105	Gloss package	100
Audi Singleframe	73	Grab handles	123
Audi sound system	106	Headlight cleaning system	99
Audi TDI clean diesel		Headlights	99
(nitrogen oxide storage catalytic converter)	98	Headlinings	121
Auxiliary heating/ventilation	102	Headroom heating	102
Bang & Olufsen Sound System	106	Heat-insulating glass	122
Bluetooth interface	108	Heat protection	102

		Page	
Fascination			
4	Audi A3 Sedan	20	Audi A3 Cabriolet
		36	Audi S3 Sedan
Technology			
48	Innovations	56	Audi tron
50	Audi ultra	58	Intelligent performance
52	Audi connect	60	Dynamics
54	quattro®	62	Assistance systems
Equipment			
70	Style guides	86	Paint finishes/hoods
72	S model	88	Wheels/tyres
74	Engines	90	Seats/seat upholstery
76	Equipment lines	96	Inlays
80	S line	98	Technology
82	Audi design selection	99	Light
84	Audi exclusive	100	Design
		100	Control elements
		101	Comfort
		103	Transport
		103	Safety
		104	Assistance systems
		105	Infotainment
		108	Audi Extended Warranty
Other			
110	Audi Genuine Accessories	115	Dimensions
112	Technical data	118	Index
		126	The fascination of Audi

Dialogue: Audi QR codes

Experience Audi even more directly: download a QR app to your smartphone and then scan the QR code or use the link provided in your browser.



The equipment for the vehicles illustrated in the Fascination section can be found on page 125.
The fuel consumption and CO₂ emission figures as well as the efficiency classes can be found from page 112 onwards.



A3

Audi A3 Sedan

Great things cast
a long shadow.



Dynamic contours. Taut, muscular areas. Coupé-like lightness. The Audi A3 Sedan casts the term “sedan” in a whole new light. Sporty through and through. Elegant and confident. Ready to discover the world anew.

The fuel consumption and CO₂ emission figures as well as the efficiency classes can be found from page 112 onwards.

New design. Breathtakingly fascinating.



The very first impression is a statement. Wide. Low. Compact. Precise lines that perceptibly create volume. A Singleframe that exudes power. Optional full-LED headlights. Perfectly integrated in the three-dimensional body line. Air intakes and a striking spoiler edge promise sportiness. And that promise is kept by a fascinating vehicle: the Audi A3 Sedan.

The fuel consumption and CO₂ emission figures as well as the efficiency classes can be found from page 112 onwards.





New driving experience. Thrillingly dynamic.

Dynamics. Consistently all along the line. Perceptible through powerful and efficient TFSI® and TDI® engines. On request, even more agile thanks to precise and direct progressive steering. Efficient and sporty thanks to the optional S tronic® dual-clutch transmission. Thrilling right from the start.







No journey is too far. Dynamism meets driving comfort. The optional Audi drive select feature allows the vehicle's characteristics to be individually adapted to the driving situation. Or to the driver's mood. At the press of a button. And on request, a whole range of assistance systems is available to support superior and relaxed driving.



The fuel consumption and CO₂ emission figures as well as the efficiency classes can be found from page 112 onwards.



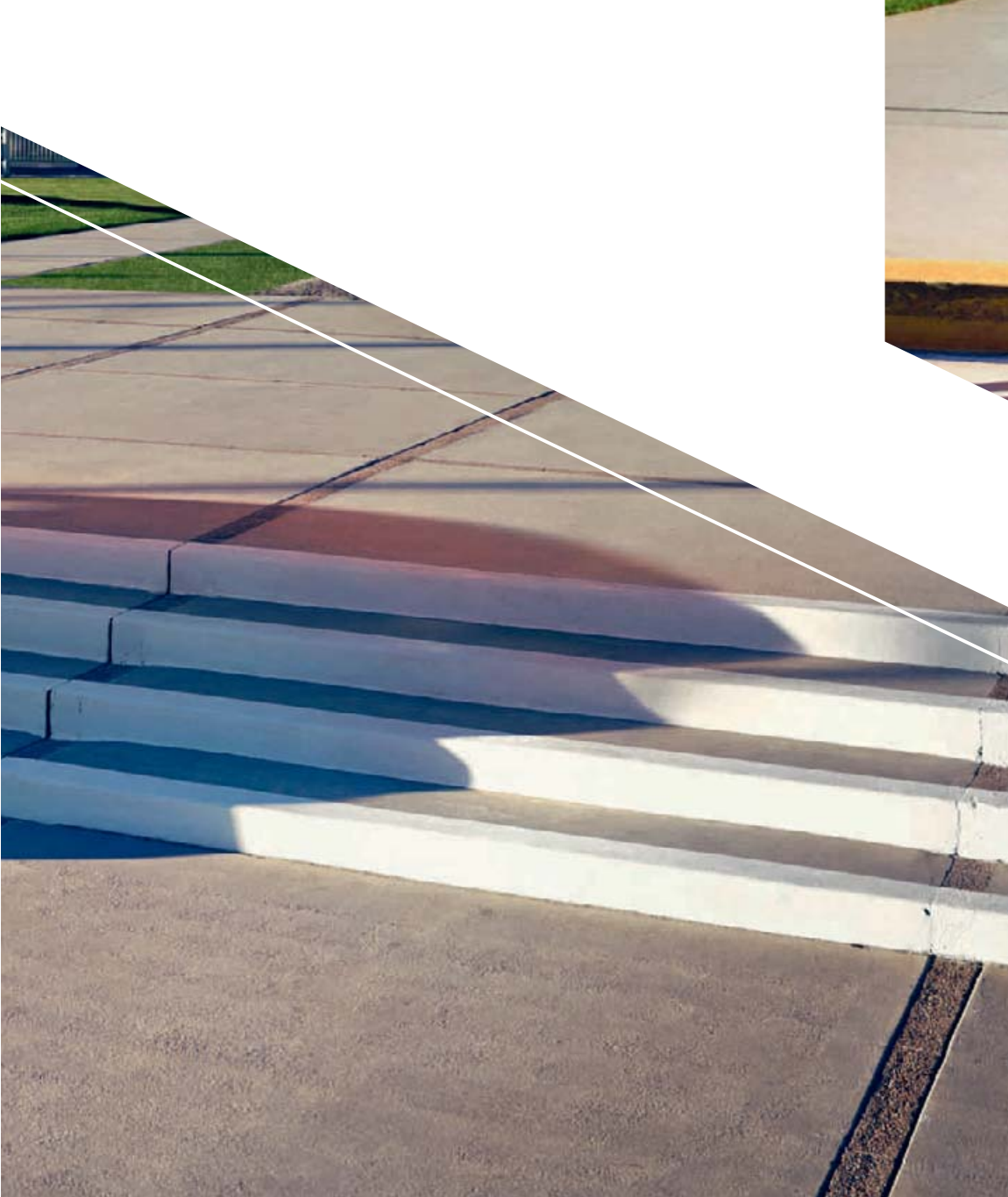

New body line. Progressively sporty.

A new view: compact sedan with coupé character. The low, flowing roof line conveys dynamism. Powerfully flared wings with striking wheel housings frame the wheels, which are optionally available up to 19 inch. Wide track. Short projections. A striking trailing edge and elegantly rising rear lights. The Audi A3 Sedan: progressive sportiness.

The fuel consumption and CO₂ emission figures as well as the efficiency classes can be found from page 112 onwards.



Space for a new era. Noticeable even as you take your seat in the high quality interior thanks to the wide vehicle shoulders and long wheelbase. On elegant Milano leather seats if you wish. The interior has been tidied up intelligently, with user interfaces reduced for increased functionality. For example through the optional intuitive MMI navigation plus with MMI touch. Then use of the services supported by Audi connect. And the high resolution, pop-up colour display is available with a large screen size of up to 7 inches too.

New spaces. Extraordinarily comfortable.





New efficiency. Convincingly sustainable.

Set off feeling good. Thanks to Audi ultra. Less weight. Enhanced efficiency. And thereby increased range. And lower emissions. Supported by impressive aerodynamics. And a start-stop system and recuperation.

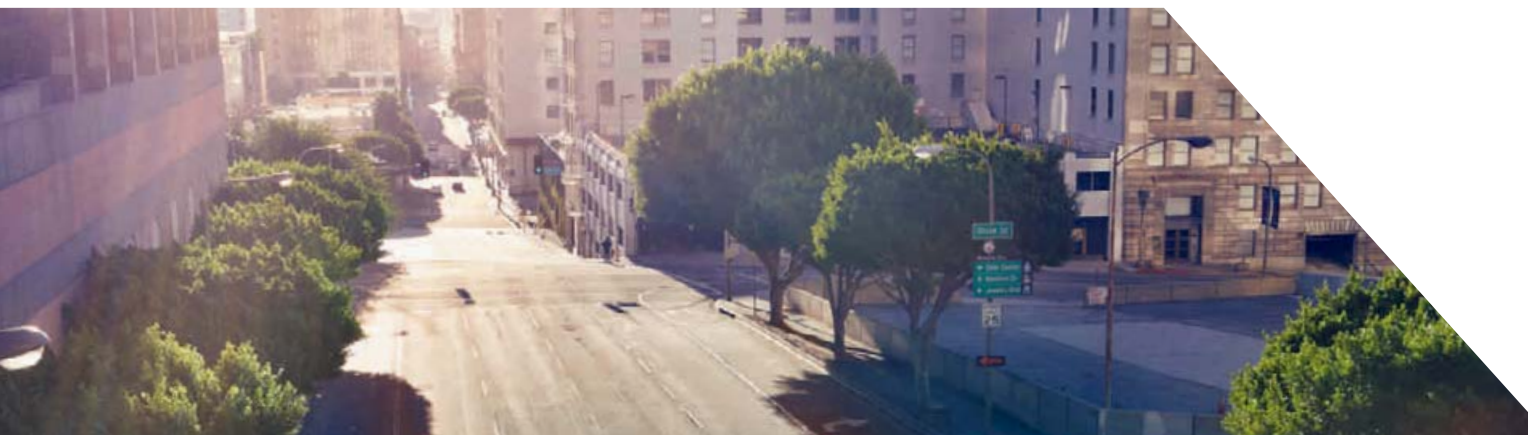

The fuel consumption and CO₂ emission figures as well as the efficiency classes can be found from page 112 onwards.





If you would like to experience the Audi A3 Sedan in action, scan this QR code using your smartphone (connection costs depend on mobile phone contract). Or follow this link in your browser:
www.audi.com/a3saloonfilm

The fuel consumption and CO₂ emission figures as well as the efficiency classes can be found from page 112 onwards.

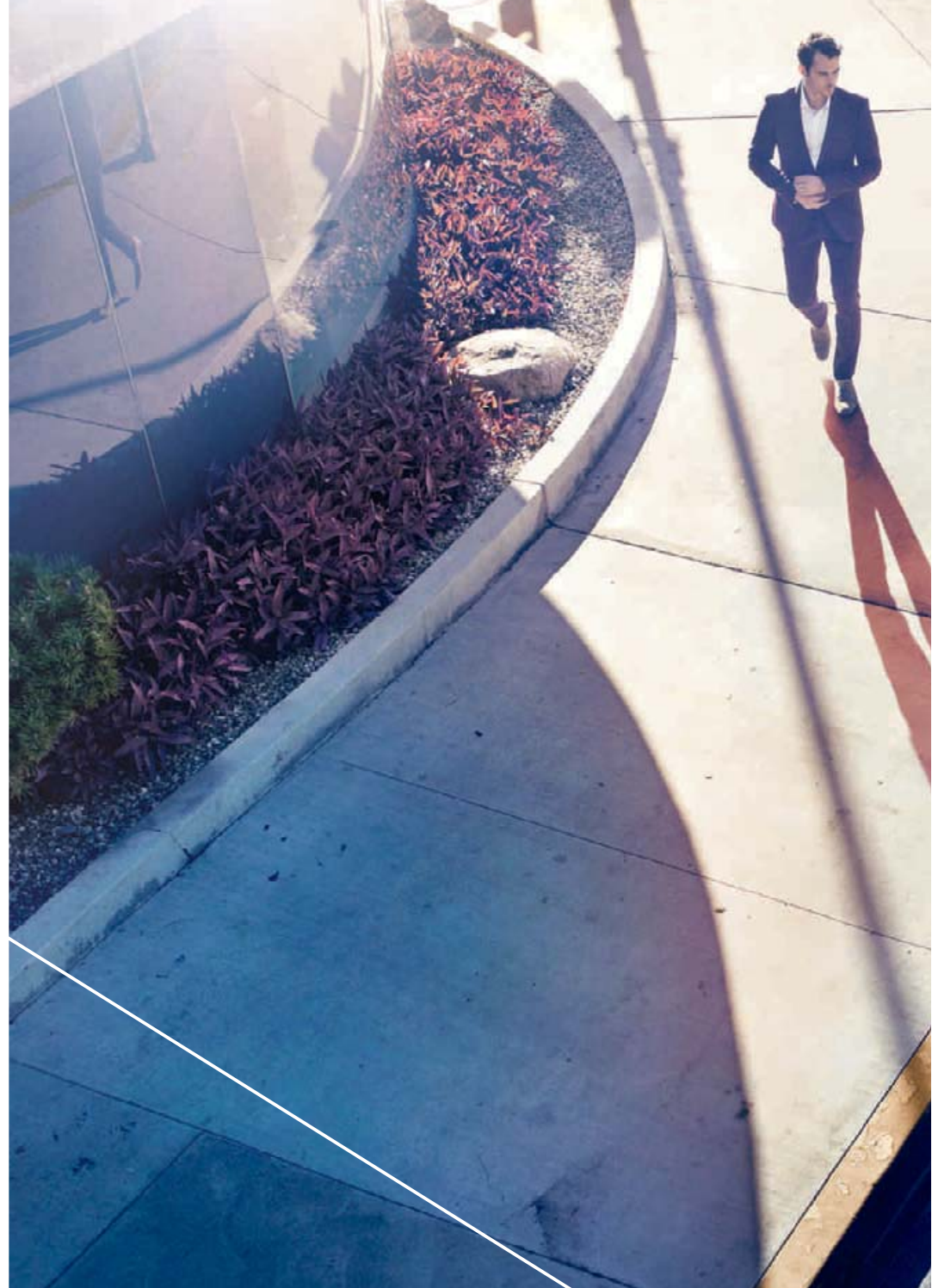

The Audi A3 Sedan
opens up undreamed-of perspectives.

Are you ready?



Moving

moments.

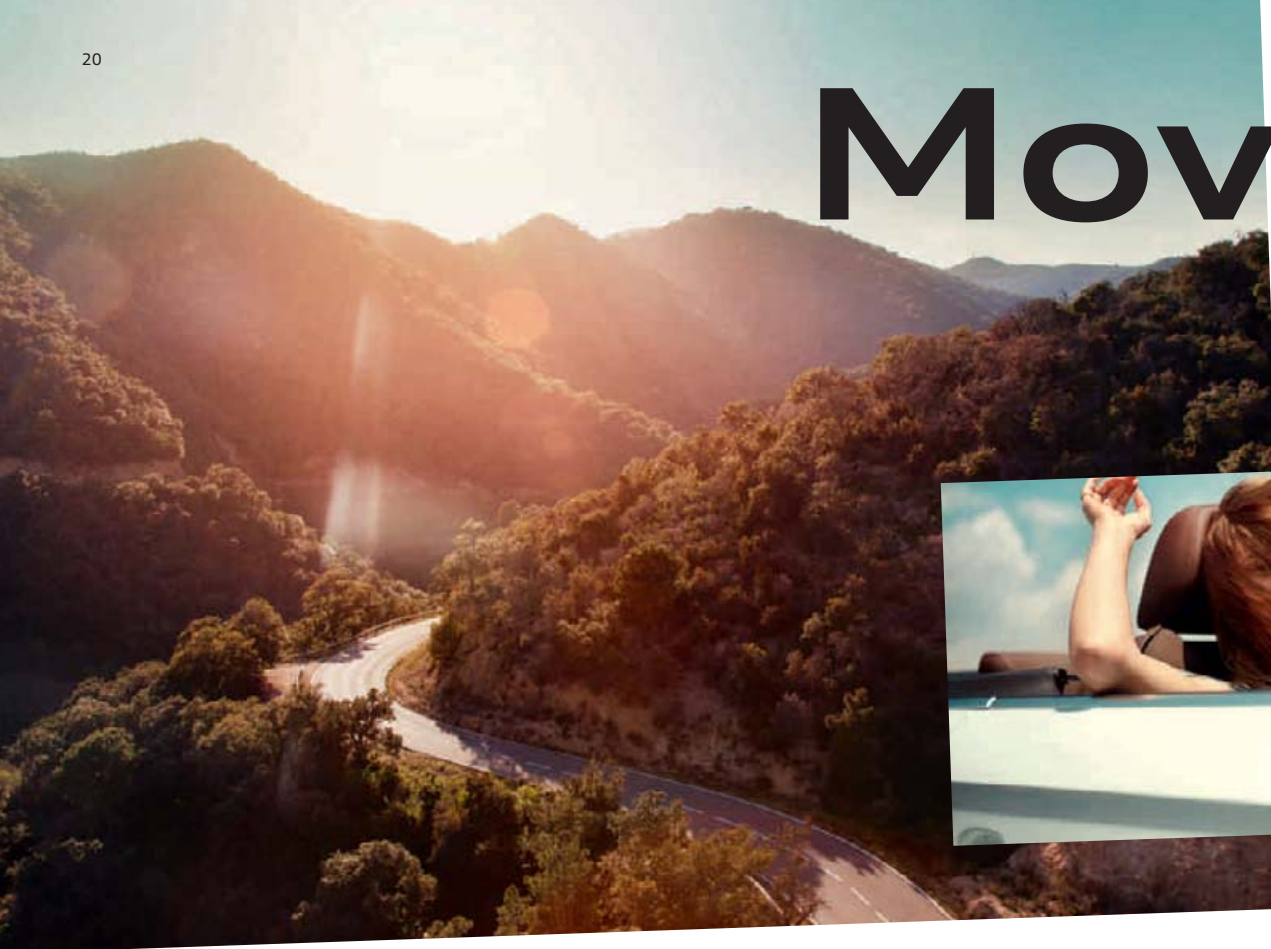

A3

Audi A3 Cabriolet





The new Audi A3 Cabriolet.



If you want to experience the Audi A3 Cabriolet in action, scan this QR code using your smartphone (connection costs depend on mobile phone contract). Or follow this link in your browser: www.audi.com/a3cabrioletfilm



The fuel consumption and CO₂ emission figures as well as the efficiency classes can be found from page 112 onwards.



Inspiring

freedom.

Fascination at first sight. Lines with depth. Dynamic proportions. Combined together with elegant lightness. The new Audi A3 Cabriolet. Sporty even when stationary. Inspiring. Open to new ideas. And boundless freedom.

The fuel consumption and CO₂ emission figures as well as the efficiency classes can be found from page 112 onwards.









Breathtaking

character.

New Perspectives. Boundlessly thrilling. Opened by the standard fully automatic fabric hood. Even when driving at up to 50 km/h. And especially quiet with an optional high-quality acoustic hood. Or accentuated with strong sound. With the Bang & Olufsen Sound System available on request.







Take a moment. Allow the impressive design to sink in. Emotional. Striking and sporty. With distinctive wheel housings. That can also house larger optional wheels. Up to 19". Standard aluminium-look exterior. Active roll-over protection system. Sophisticated. High-quality. Going in the right direction.

The fuel consumption and CO₂ emission figures as well as the efficiency classes can be found from page 112 onwards.

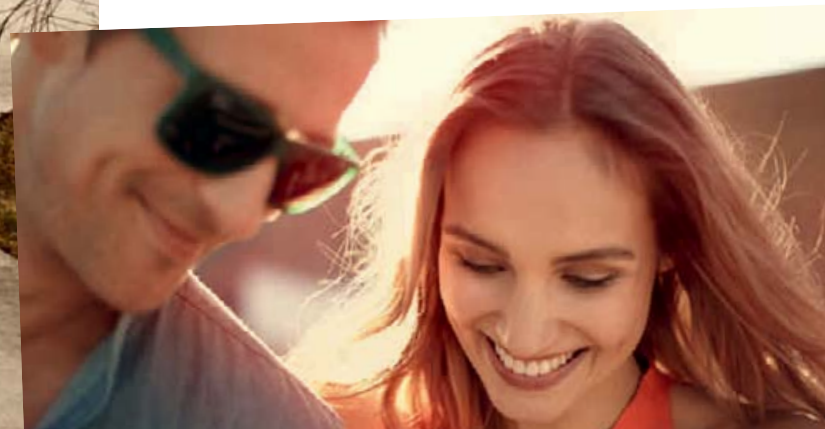



Thrilling

perspectives.

Inner values. Extraordinary. An inviting spatial design. Horizontally oriented architecture. Harmoniously integrated interior. Premium equipment. Heated sport seats and headroom heating on request. And on top of that, high-level infotainment. Optionally including MMI navigation plus with MMI touch.



The fuel consumption and CO₂ emission figures as well as the efficiency classes can be found from page 112 onwards.

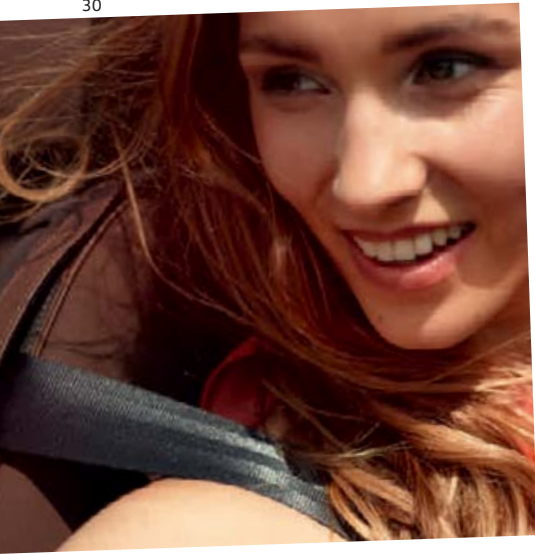

Driving

dynamics.



Driven by powerful dynamics. Towards the sun. Or vice versa. The journey becomes the reward. And when it's late, night turns into day. With innovative optional full-LED headlights.

The fuel consumption and CO₂ emission figures as well as the efficiency classes can be found from page 112 onwards.









Enjoy nature. Rediscover it. And protect it. Thanks to the start-stop system. Recuperation. And Audi drive select with efficiency mode – a standard feature of the Ambition equipment line. Plus powerful, efficient engines. TDI and TFSI. Supported by Audi ultra.

The fuel consumption and CO₂ emission figures as well as the efficiency classes can be found from page 112 onwards.





Enduring

passion.

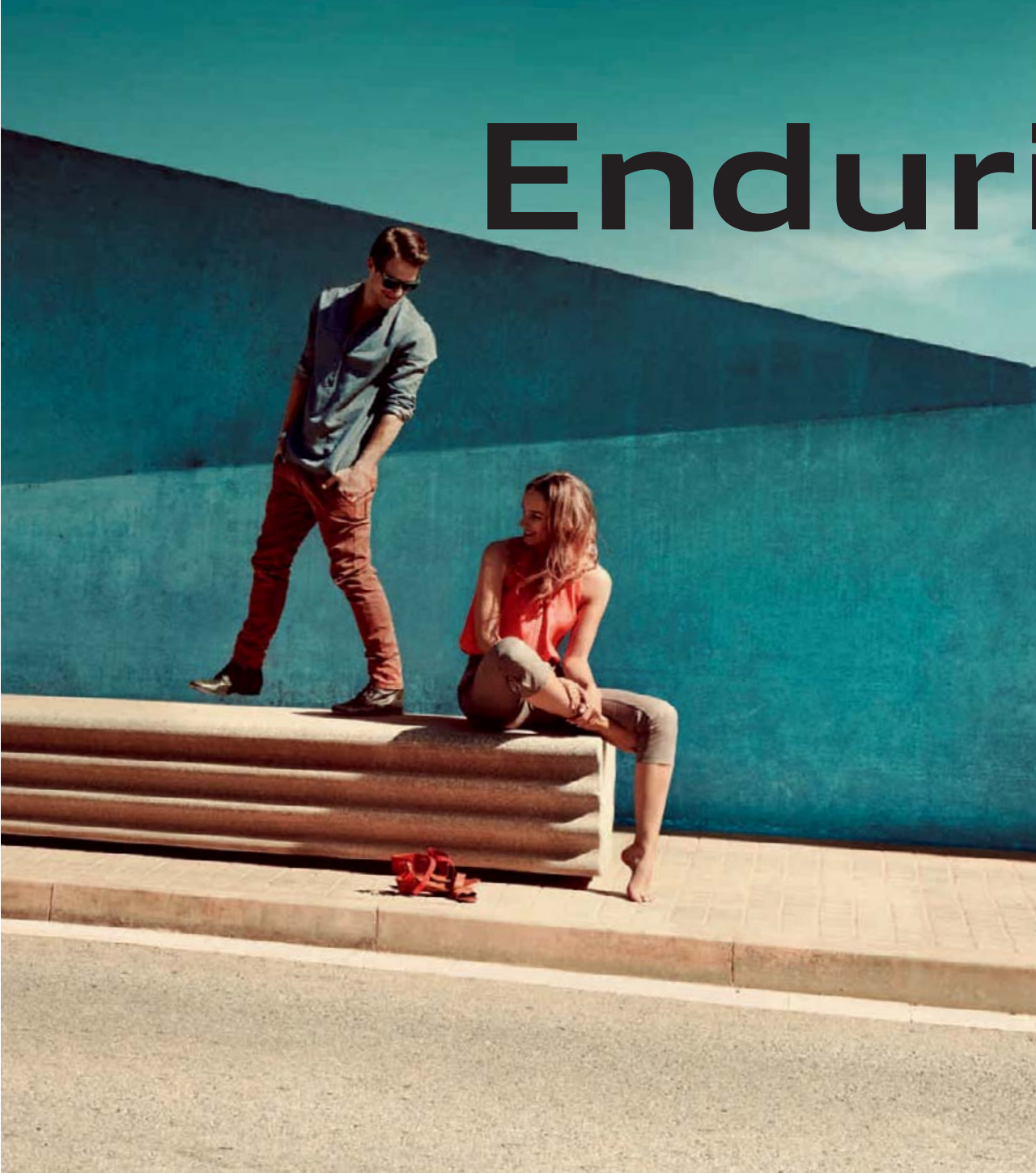

The art of enjoying life. Spontaneously. Passionately. Intensely. With no limitations. With the Audi A3 Cabriolet, the world is yours. Each day is a new day.

The fuel consumption and CO₂ emission figures as well as the efficiency classes can be found from page 112 onwards.





**New movement.
Even sportier.**

S3

Audi S3 Sedan

The fuel consumption and CO₂ emission figures as well as the efficiency classes can be found from page 112 onwards.





New concept. Even more fascinating.



The sedan with the S-factor. Stronger. Sportier. Fascinating at first sight. With a unique look. Typical S. Rear diffuser and dual-branch exhaust system. Oval twin tailpipes. An appearance that arouses expectations. And satisfies them. Inspirational. The Audi S3 Sedan.

The fuel consumption and CO₂ emission figures as well as the efficiency classes can be found from page 112 onwards.

New driving experience. Even more dynamic.



Increased dynamism. 221 kW. From 0 to 100 km/h in 4.9 seconds with S tronic. Power that captivates you. 380 Nm. Distributed to four wheels. From the quattro permanent all-wheel drive. Superior and standard.

The fuel consumption and CO₂ emission figures as well as the efficiency classes can be found from page 112 onwards.





New spaces. Even more intense.



Impressive sportiness. For an intense experience. On request in the S sport seat with outstanding lateral support. The S-specific start-stop button in view. All systems go. A firm grip on the optional flat-bottomed multifunction sport leather steering wheel. Dynamism you can feel. Forward thrust. Realised with precision. With additionally available MMI navigation plus with MMI touch. User-friendly integration of optional services supported by Audi connect. That's how ground-breaking a cockpit can be.

The fuel consumption and CO₂ emission figures as well as the efficiency classes can be found from page 112 onwards.



Dynamism you can feel. And see. For example in the wheels, which are optionally available up to 19". 5-twin-spoke star design. Contrasting grey. Partly polished. S-characteristic. Worthy to perform.

The fuel consumption and CO₂ emission figures as well as the efficiency classes can be found from page 112 onwards.





Another quick glance to the rear. In the aluminium-look exterior mirror. To see the lead increasing. Because the S3 Sedan knows only one direction. Ahead. Uniquely sportily ahead.

The fuel consumption and CO₂ emission figures as well as the efficiency classes can be found from page 112 onwards.





v



>>> Audi connect

The future of connected mobility.

r

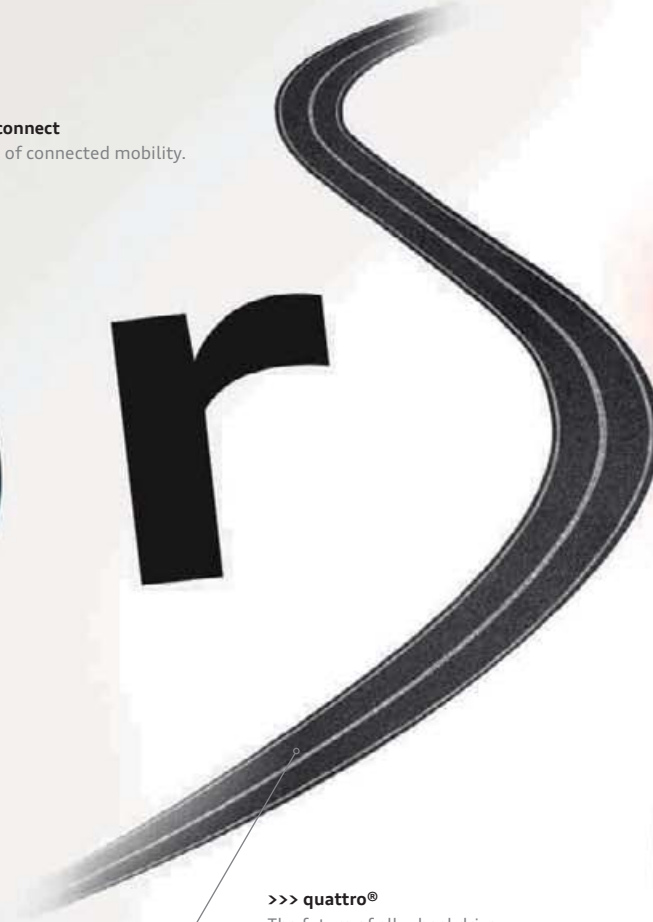

>>> quattro®

The future of all-wheel drive.



>>> Audi tron

The future of CO₂-reduced mobility.



running

>>> Audi ultra

The future of efficient technology.

>>> Design

Reshaping the future.

... durch Technik.

The world is constantly changing. Technology is advancing at an ever faster pace. And in the process, more and more opportunities are opening up to you – nowhere more so than in the field of mobility. We are playing an instrumental role in shaping this progress with Vorsprung durch Technik. Striving to provide you with technology that enriches your life. Making sure that we don't just satisfy your expectations of mobility both today and in the future, but continue to surpass them.





Audi ultra

Every last gram carries weight.

We don't take the task of building an Audi lightly – yet lightness is a top priority. You just have to know how to dispense with things: with superfluous materials, with excess weight, with outdated design principles. What began with the revolutionary Audi Space Frame (ASF®) now has an impact on the entire production process. Existing forms and materials are questioned. Manufacturing processes are optimized. Components are carefully weighed up in every sense so that we can build even lighter vehicles that make more sparing use of resources. Such as the wheel hub pictured here, whose chamfered edges have shaved 200 grams off its weight. Because the less an Audi weighs, the more innovations we can fit in. For more comfort and safety. For enhanced efficiency and dynamic performance that produces lower CO₂ emissions – for example through Audi cylinder on demand, the start-stop system or recuperation. For even more Audi.

Mobility & navigation

POI **Point-of-interest (PoI) search**
in the Google™¹ database, for the A3 Sedan/
S3 Sedan with voice control

Traffic information online
complements the dynamic route guidance
with real-time traffic flow information for
individual stretches of road

myAudi special destinations²
The navigation system as a personal road
atlas: import individual point-of-interest
(PoI) lists to the vehicle via the myAudi
portal.

Flight information
Get information conveniently from inside your
vehicle about departure and arrival times as
well as the corresponding gates and search
directly for flight numbers on request.

Train information
Find departure and arrival times and the
right platforms when you're on the road.
(Also available for additional public transport
modes, e.g. underground systems)

Country-specific information²
display of country-specific information,
e.g. on valid speed limits, motorway sticker
requirement when passing the border, etc.

Picturebook navigation
GPS data from your photos get you to your
destination.

Fuel prices
the cheapest filling stations around your
location or destination

P **Parking information**
Help with looking for parking spaces or multi-
storeys including price details. Up-to-date
information on vacant spaces is also displayed,
provided such information is available in the
database.

**Navigation with Google Earth™¹ and
Google Street View™¹**
uses high-resolution aerial and satellite
images, photos and address information to
guide you to your destination even more
easily

Map update service²
The map version delivered can be updated a
total of 5 times at intervals of six months.

Communication

Wi-Fi hotspot
connects your mobile devices to the internet

Email²
can be transmitted to your Audi MMI® and
conveniently read out

Messages
can be transmitted to your Audi MMI for
the A3 Sedan/S3 Sedan and text messages
(SMS) can be conveniently read out or
composed using the dictation function

Access to Facebook
integrates your personal network into
the cockpit. With text-to-speech and other
convenient text functions

Access to Twitter
integrates the Twitter message service
into the cockpit. With read-aloud and other
convenient text functions

¹ Google and the Google logo are registered trademarks of Google Inc. ² Part of MMI navigation plus with MMI touch.

Availability, screen display and the cost of services vary depending on the country, model, device and tariff. For further legal information and notes on use, please see page 107 or visit www.audi.com/connect.



audi connect.



myAudi – your personal control centre

provides you with password-protected access to www.audi.com/myaudi where, following a one-off registration, you are able to select and manage the services supported by Audi connect as desired and configure them from the comfort of your own home. Destinations can be entered via www.audi.com/myaudi or from a mobile device using the MMI connect app or Google Maps™¹.

Audi connect

The future of connected mobility.

The world presents you with countless possibilities. Audi connect enables you to make the most of many of them in digital form directly from your Audi. At the push of a button. Tailored to you. Thanks to myAudi and the services supported by Audi connect in your vehicle. In places all over the world. Intuitively, easily and conveniently.

Infotainment



Weather

forecasts and maps for the required destination



Audi music stream

Access to global radio stations via smartphone app and Wi-Fi, plus access to your smartphone's media library



News online (individual)

text and images about current world events, with text-to-speech function, can be custom configured



City events

provides you with up-to-date information about events – e.g. at your destination



Travel information

offers you sightseeing information – with function for importing destination to navigation system



quattro[®]
**Stick to
the road.**

With quattro[®].

Have the road completely under control, thanks to permanent distribution of the drive force to all four wheels. The rear axle is variably controlled via hydraulic multi-plate clutch. Always as the situation demands, always selective. Experience handling stability, dynamism and agility as never before and combat the effects of over- and understeer with quattro. For increased traction and superior propulsive power. Tame any road. And always keep your eyes set on where you're heading. In bends. On straights. Over any surface. For a fascinating experience that sticks. To the road – and in your mind.



Audi tr

Audi g-tron

Audi g-tron offers a carefree, cost-effective way to “hit the gas”. Compressed Natural Gas, to be precise – or CNG for short. Compared to conventional fuels, burning CNG gives off considerably less CO₂. CNG gives the Audi A3 Sportback g-tron a purely gas-powered range of up to 400 kilometres – and hallmark Audi driving dynamics: full of poise and power.



Values according to the ECE standard for the Audi A3 Sportback g-tron: fuel consumption: 3.3–3.2 kg CNG/100 km; CO₂ emissions: 92–88 g/km; values according to the ECE standard for the Audi A3 Sportback e-tron: fuel consumption: 1.5 l/100 km; CO₂ emissions: 35 g/km. For information on when this feature will be available, please contact your Audi partner.



n

Ahead with less CO₂.



Audi e-tron

Mobility is set to change. With Audi e-tron, we are already defining how. Alongside the hybrid drives already available in several of our models, soon Audi will also be offering emission-reduced vehicles featuring plug-in hybrid technology. Allowing the Audi A3 Sportback e-tron, for example, to travel up to 50 km powered purely by electricity. And all this not just to promote sustainability, but to shape it, too.

Intelligent performance

Maximum power. Put to maximum use.

Every movement originates from something. Something that set it off, an idea. The engines for your Audi can also be traced back to an initial spark of inspiration: higher power with lower fuel consumption. These apparently conflicting aims are reconciled in two revolutionary drive technologies: TDI® and TFSI®. Get acquainted with both of them. And then opt for the drive system that you feel most moved by.





TDI®

With their combination of direct injection and turbocharging, Audi TDI engines promise exceptional performance – thanks to their high torque output over the entire engine speed range with constant power build-up. They are renowned for being fuel-efficient and for reducing emissions. But they are incredibly dynamic too – letting you get the maximum out of any road.



TFSI®

Audi TFSI engines attain a particularly high compression rate. The result: outstanding efficiency combined with optimum performance. Substituting supercharging for cubic capacity has the effect of considerably reducing engine size and weight – while performance remains as impressively dynamic as ever. For power delivery that will win you over from the word go.

Audi cylinder on demand

Even cylinder heads can be intelligent, as Audi cylinder on demand proves. Cylinders two and three of the TFSI engine's four cylinders automatically shut down in the partial-load range. This helps to lower fuel consumption at the same time as reducing emissions. And without the switchover even being noticed or impairing the driving dynamics.



>>> Audi drive select

Audi drive select lets you adapt the driving characteristics of your Audi to your requirements. All at the push of a button. Sportier, more comfortable, more balanced or more economical. It's entirely up to you.

>>> S tronic®

The sporty, efficient dual-clutch transmission allows you to switch gears with lightning speed without a noticeable break in propulsive power.

>>> Electromechanical power steering

The speed-sensitive power steering conveys a precise steering feel even at high speeds, helps you to countersteer and makes light work of parking.

>>> Progressive steering

Enhanced driving dynamics due to a more direct steering ratio as well as increased driving comfort in everyday driving conditions due to reduced steering effort. The progressive steering's adjustable, angle-dependent power steering offers you ideal steering characteristics in every driving situation.

>>> Audi magnetic ride

The regulation of the damping forces based on the driving situation can be set between comfortable and sporty.

>>> quattro®

The permanent all-wheel-drive system distributes the drive forces to each individual wheel according to the driving situation for extra traction and dynamic performance.



Dynamics

Dynamics

that will take a hold of you.

Get in. Buckle up. Start the engine. Wherever you're heading, enthralling driving dynamics will power you there. For as you know, the world is your oyster once you get behind the wheel of your Audi. You decide the direction. The driving style. The pace. And you enjoy the satisfaction of knowing you have plenty in reserve. More than enough to get the very best from every drive.



**>>> adaptive cruise control including
Audi pre sense front**

monitors the traffic in front of you, brakes or accelerates automatically to maintain distance, and warns you about vehicles early on.

>>> Audi side assist

monitors traffic behind the vehicle and helps you when changing lanes.

>>> Audi active lane assist

helps you to keep in lane by means of gentle steering intervention when lane boundary markings are detected. Camera-based traffic sign recognition is integrated in conjunction with MMI navigation plus with MMI touch.

>>> Audi pre sense basic

detects the current driving situation and initiates preventive measures for your protection and that of other passengers if required.

Assistance systems

Wherever you're heading, peace of mind will be your constant companion.

With the assistance systems in your Audi.

Each drive is different. Yet they all have one thing in common – the feeling of being protected that you get from every Audi. All driver assistance systems in your Audi help you during your journey and guarantee even greater comfort when you're on the road. Get to know the most important driver assistance systems.

>>> LED headlights

illuminate the lane precisely using light similar to daylight. Different light distribution modes provide additional safety and comfort as well as excellent recognition by other road users.

>>> Parking system plus with selective display

provides a better overview for parking and manoeuvring by showing visual displays of the vehicles' surroundings.

>>> Park assist with selective display

helps you to manoeuvre into parallel and perpendicular parking spaces as well as out of parallel parking spaces again with a virtually automatic steering process.

>>> Audi connect

Use all the optional services supported by Audi connect with MMI navigation plus with MMI touch – quickly and easily. The intuitive operation of the MMI makes accessing many internet-based functions remarkably straightforward.

>>> Navigation

With MMI navigation plus with MMI touch, you can let yourself be guided to your destinations with even greater ease via its 3D map view and 3D display of places of interest and landmark buildings.

>>> Car

Control and alter driver assistance systems, vehicle settings as well as climate control and service functions quickly and easily using the MMI radio.

>>> Phone

Make phone calls safely and easily using the hands-free facility: simply select the number to dial from your contacts in the MMI or enter the number intuitively via the MMI touch.

>>> Media

Browse through the covers of your music collection on all available media sources, such as a jukebox, inserted SD cards, Audi music interface or CDs, as well as – in conjunction with MMI navigation plus with MMI touch – DVDs.

MMI

>>> MMI touch

MMI touch makes operating the individual components of the Multi Media Interface even easier. The built-in touchpad integrated in the rotary/push-button control can even be operated using just one finger.



Simplexity

The MMI® – intelligent, individual, intuitive.

Streamlined. Simple. Logical. The world of mobile infotainment completely redefined: the optional Multi Media Interface (MMI). Phoning, navigate, or surfing the internet via Audi connect available on request: all highly intuitive, highly functional and highly convenient – not least thanks to the voice control function available in the A3 Sedan and the S3 Sedan. With the optional MMI radio or MMI navigation plus with MMI touch, everything will be child's play for you when you're in your Audi.



LED headlights

Lights

State-of-the-art LED technology. That illuminates roads excellently. Following a natural principle: vision is best during the day. With colour temperature similar to daylight, the light of the Audi LED headlights helps to reduce eye fatigue. Route data is used to adjust the light distribution to the respective situation. In advance. Thanks to being networked with MMI navigation plus with MMI touch. So that as little as possible escapes you – and your Audi catches the eye.

Look







As unique as you are. The equipment options.

Sportiness, comfort, design, functionality – whatever you demand of your Audi, it offers you a wealth of custom options. Audi equipment versions are varied and high-quality and you can tailor them entirely to your needs.

Character takes on many forms. Here are two of them.

What makes an Audi your Audi? Vehicle equipment entirely tailored to your needs. Many options are available to you for giving your vehicle the exact touch you have in mind. More sportiness? More elegance? Let yourself be inspired.

Audi A3 Sedan Ambition in Misano red, pearl effect

Cast aluminium wheels in 10-spoke dynamic design

Sport seats in Alcantara/leather, black

Inlays in aluminium mistral, silver

Bang & Olufsen Sound System

Multifunction sport leather steering wheel in 3-spoke design flattened at the bottom



The fuel consumption and CO₂ emission figures as well as the efficiency classes can be found from page 112 onwards.



**Audi A3 Cabriolet Ambiente
in phantom black, pearl effect**

Cast aluminium wheels in 5-spoke star design

Hood in black

Standard seats in Milano leather, pashmina beige

Inlays in 3D-design "Optic"

Aluminium look in the interior



Sportiness that can be seen and felt. Even when stationary.

S stands for sportiness. Your Audi S3 Sedan is impressive proof of this. With extensive S-specific equipment. For a dynamic look. Sporty comfort. And superior performance. And you also have the option of further enhancing the S-factor. With optional equipment that is equally impressive to the senses.



The fuel consumption and CO₂ emission figures as well as the efficiency classes can be found from page 112 onwards.

S-specific standard ranges

Cast aluminium wheels

in 5-parallel-spoke design (S design)

partly polished, size 8 J x 18 with 225/40 R 18 tyres¹

Audi Singleframe

Radiator grille in platinum grey with horizontal chrome struts. With chrome-plated, centred Audi rings

Bumpers

in a striking sporty design with air inlet ducts in honeycomb design with double chrome struts

Exterior mirror housings

in aluminium look

Side sill trims

Brake callipers, painted black

with S3 logo at the front, support the dynamic character of the vehicle by giving the brake system a sportier appearance

Diffuser insert, rear

with double chrome strut

Exhaust tailpipes

Dual-branch exhaust system each with 2 oval, chrome-plated tailpipes to the left and right

Rear spoiler

on the luggage compartment lid

Model/technology name

Model name S3 on the luggage compartment lid and in the radiator grille. Also available without model/technology name on the rear.

Model name S3 in rev counter and in the MMI display. quattro logo on the front passenger side in the dashboard

Door sill trims

on the door sills with aluminium inlay and S3 logo

Pedals

and footrest in brushed stainless steel

Instrument cluster

with integrated charging pressure display and grey dials

Aluminium look in the interior

Sport seats, front

Seat upholstery in trophy cloth/leather

with contrasting stitching and S3 embossing on the front-seat backrests

Headlining in black cloth

Inlays

Matt brushed aluminium

Sport leather steering wheel in 3-spoke design

with S3 emblem and S-specific contrasting stitching

S sport suspension

more dynamic spring/damper setting and vehicle lowered by 25 mm

quattro® permanent all-wheel drive

Progressive steering

Xenon plus headlights including headlight cleaning system

Audi drive select

Driver information system with colour display

Deluxe automatic air conditioning

Centre armrest, front

Storage and luggage compartment package

Illuminated vanity mirror

Anti-theft alarm

Optional equipment ranges (extract)

Further 18-inch wheels as well as 19-inch wheels in conjunction with Audi magnetic ride

Brake callipers, painted red

Engine start-stop button

with red anodised ring (in conjunction with optional convenience key)

S sport seats, front

S-specific seat upholstery

- Alcantara/leather, black or lunar silver
- Fine Nappa leather, black or lunar silver
- Audi design selection parade red each with contrasting stitching and S3 embossing on the front-seat backrests

Inlays

3D-design "Black"

Multifunction sport leather steering wheel in 3-spoke design flattened at the bottom

with S3 emblem and S-specific contrasting stitching and optionally with shift paddles in aluminium look

Audi magnetic ride

Paint finishes in selected standard/special equipment colours, additional S-specific paint finishes in the special colours Sepang blue, pearl effect² and panther black, crystal effect

¹You will find specifications on the technical characteristics of tyres on page 114. ²For information on when this feature will be available, please contact your Audi partner.

The right driving force for every personality.

It doesn't matter which Audi engine you choose, they all have high compression ratios, highly efficient combustion and outstanding efficiency. In short, they deliver more power whilst using less fuel and producing fewer emissions.





**1.4 litre TFSI engine
with Audi cylinder
on demand technology**

TFSI®

Audi TFSI engines: impressive efficiency with enhanced performance – and this with dynamics that remain the same. For example: the 1.4 TFSI (103 kW) with Audi cylinder on demand technology in the Audi A3 Sedan and Audi A3 Cabriolet. Or the 2.0 TFSI quattro with 221 kW in the Audi S3 Sedan. For S tronic with an acceleration of 0 to 100 km/h in 4.9 seconds.

- A3 Sedan 1.4 TFSI (92 kW)
- A3 Sedan/A3 Cabriolet 1.4 TFSI (103 kW)
with Audi cylinder on demand technology
- A3 Sedan/A3 Cabriolet 1.8 TFSI (132 kW)
- S3 Sedan 2.0 TFSI quattro (221 kW)

The fuel consumption and CO₂ emission figures as well as the efficiency classes can be found from page 112 onwards.



2.0 litre TDI clean diesel engine

TDI®

Audi TDI engines: high torque output over the entire engine speed range – with constant power build-up. They are renowned for being fuel-efficient and for reducing emissions. Like the 2.0 TDI clean diesel: 110 kW. In the Audi A3 Cabriolet with a maximum speed of 224 km/h and an acceleration of 0 to 100 km/h in 8.9 seconds.

- A3 Sedan 1.6 TDI (77 kW)
- A3 Sedan 2.0 TDI (110 kW)
- A3 Sedan/A3 Cabriolet 2.0 TDI clean diesel (110 kW)

From sportiness to luxury. The choice is yours.

You can shape your Audi A3 entirely according to your wishes: with three fascinating equipment lines. Give it its own personality as Attraction. Give expression to pure sportiness with the Ambition equipment line. Or let yourself be seduced by luxury and comfort with the Ambiente line. Whatever you have in mind: each of the equipment lines make driving in an Audi an especially exclusive experience.



**Attraction – character and emotions****Model-specific standard equipment****Interior distinguishing features:**

Inlays in micrometallic, silver for door trims and dashboard

Seat upholstery in marathon cloth

Exterior distinguishing features:

Steel wheels with full wheel covers, size 7 J x 16 with 205/55 R 16 tyres*

Functional distinguishing features:

Steering wheel, padded, in 4-spoke design



The illustrations show the Audi A3 Sedan. The fuel consumption and CO₂ emission figures as well as the efficiency classes can be found from page 112 onwards. * You will find specifications on the technical characteristics of tyres on page 114.



Ambition – sportiness and dynamics

Model-specific standard equipment

Interior distinguishing features:

Inlays in micrometallic, silver for door trims and dashboard

Door sill trims with aluminium inlays on the door sills

Seat upholstery in rallye cloth

Exterior distinguishing features:

Cast aluminium wheels in 5-arm design, size 7.5 J x 17 with 225/45 R 17 tyres*

Chrome-plated trims for exhaust tailpipes, single or double tailpipe depending on engine variant

Functional distinguishing features:

Sport seats, front

Sport leather steering wheel in 3-spoke design, includes gear or selector lever knob in leather

Driver information system with colour display, including digital speed display and onboard computer with efficiency program

Audi drive select

Front fog lights in halogen technology, integrated in the front apron

Sport suspension, can also be ordered in conjunction with dynamic suspension



Ambiente – luxury and comfort

Model-specific standard equipment

Interior distinguishing features:

Inlays in 3D-design “Optic” in door trims and dashboard

Door sill trims in black

Seat upholstery in regatta cloth/mono.pur

Exterior distinguishing features:

Cast aluminium wheels in 15-spoke Y design, size 7 J x 16 with 205/55 R 16 tyres*

Gloss package (for A3 Sedan) or wind deflector (for A3 Cabriolet)

Chrome-plated trims for exhaust tailpipes, single or double tailpipe depending on engine variant

Functional distinguishing features:

Driver information system with colour display, including digital speed display and onboard computer with efficiency program

Cruise control

Leather steering wheel in 4-spoke design, includes gear or selector lever knob in leather

Centre armrest, front

Lighting package

Parking system, rear



Remaining faithful to the sporty line: the S line packages.

The S line packages emphasise the sporty character of your Audi A3. Accentuate the dynamic body line, lend the interior even more expression or give the suspension even sportier definition for enhanced driving dynamics. And make a true athlete out of your Audi.



S line exterior package

Front and rear bumpers, side sill trims and diffuser insert

in a striking, sporty design

Radiator grille

in high-gloss black

Diffuser insert

painted in platinum grey, with honeycomb grid

Front fog lights

Front fog light surrounds

in high-gloss black

Chrome-plated trims for exhaust tailpipes

single or double tailpipes depending on engine variant

Door sill trims

with aluminium inlay and S line logo

S line logos

on the front wings

The fuel consumption and CO₂ emission figures as well as the efficiency classes can be found from page 112 onwards.



S line sport package¹

The S line sport package includes the following equipment items:

Cast aluminium wheels in 5-parallel-spoke design partly polished, size 8 J x 18 with 225/40 R 18 tyres²

S line sport suspension

with more dynamic spring/damper setting and vehicle lowered by 10 mm compared with the sport suspension or by 25 mm compared with the dynamic suspension

S line logos

on the front wings and door sill trims

Interior, dashboard and headlining/hood lining

in black, contrasting stitching on seat upholstery, sport leather steering wheel and gear or selector lever gaiter

Sport seats, front

S line seat upholstery in biathlon cloth/leather in black with S line embossing on the front-seat backrests

S line sport leather steering wheel in 3-spoke design

in black leather (steering wheel grips in perforated leather) with contrasting stitching and S line emblem

Gear or selector lever knob

in perforated black leather

Inlays

Matt brushed aluminium

Storage and luggage compartment package

Illuminated vanity mirror

Optionally available:

Further 18-inch wheels as well as 19-inch wheels in conjunction with sport suspension or Audi magnetic ride

Audi magnetic ride

S sport seats, front

S line seat upholstery in perforated Alcantara/leather or fine Nappa leather

Shoulder area in velvet leather on front sport seats and in fine Nappa leather embroidered with contrasting stitching on front S sport seats, each in black with S line embossing in the front-seat backrests

S line multifunction sport leather steering wheel in 3-spoke design, flattened at the bottom

with S tronic optionally available with shift paddles – each in black leather (steering wheel grips in perforated leather) with S line emblem

Inlays

3D-design “Black”

Paint finishes in all standard/optional equipment colours and additionally the special colour Daytona grey, pearl effect

As unmistakable as your own standards: the Audi design selection.

The Audi design selection offers you an attractive choice of interior design packages featuring exclusive materials and colours. The noble leather upholstery and trim in the colours lasso brown or parade red with attractive contrasting stitching give the interior an exclusive ambience.



Audi design selection lasso brown

The Audi design selection lasso brown* is available exclusively for the A3 Sedan and the A3 Cabriolet. The front sport seats feature a combination of black Milano leather and lasso brown velvet leather with contrasting stitching that continues the lasso brown colour, e.g. on the knee pads and the armrests. Door mirrors in lasso brown velvet leather impressively top off the accentuated, modern look. Specific details on the range of the equipment package can be found on page 95.

The illustrations show the Audi A3 Sedan. * Only available for Ambition.

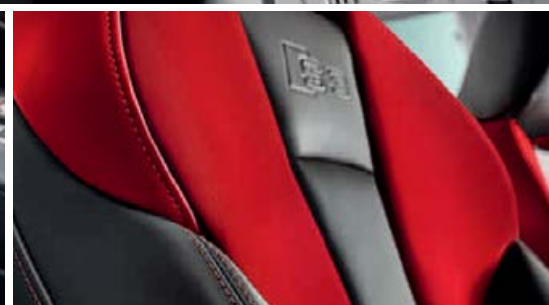
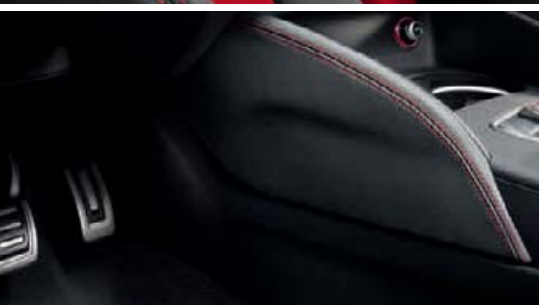

Audi design selection parade red

The Audi design selection parade red available for the Audi S3 Sedan is distinguished by the front sport seats in noble black fine Nappa leather and by the contrasting stitching in parade red. The parade red colour of the shoulder inserts of the sport seats in velvet leather is taken up by the contrasting stitching, which can be found, for example, on the sport leather steering wheel, the knee pads and on the gear or selector lever gaiter. Specific details on the range of the equipment package can be found on page 95.

You have an exclusive character. So why shouldn't your Audi have one too?

That the Audi exclusive* range aspires to exclusivity is already evident from its name. It combines coloured leather with customised paint finishes from the large selection of Audi exclusive colours to suit your own personal preferences. So you can highlight your car's exceptional character to even better advantage. Your Audi partner and the Audi exclusive Studio of the Audi Forum Neckarsulm await your wishes.





**Audi A3 Sedan Ambition with
customised paint finish Racing Blue Mica**

Audi exclusive cast aluminium wheels in 10-spoke design in matt titanium look, gloss turned finish

Leather upholstery and trim (package 1) in fine Nappa leather Audi exclusive in alabaster white and cloudy grey with contrasting stitching

Audi exclusive extended leather upholstery and trim

Audi exclusive leather controls

Inlays in matt brushed aluminium



The fuel consumption and CO₂ emission figures as well as the efficiency classes can be found from page 112 onwards. *For information on when this feature will be available, please contact your Audi partner.

Your Audi is painted not just once. But four times.

When you choose a paint colour, choose one that best reflects your own personality. But regardless of which colour you opt for, you can count on the outstanding quality of our painting process. Though no thicker than a human hair, the layer of paint on an Audi is actually made up of four different coats. So not only do you look radiant in your Audi, the car is also optimally protected from environmental influences and wear. For its entire lifetime.





Quality you can see and feel: the optional acoustic hood captivates with its high-quality covers in different colours and a hood compartment with circumferential aluminium bar. It can be opened and closed at speeds up to 50 km/h and its fine interior materials always ensure a pleasantly quiet ride as well as excellent heat insulation.

| Hood colours



Hood, black

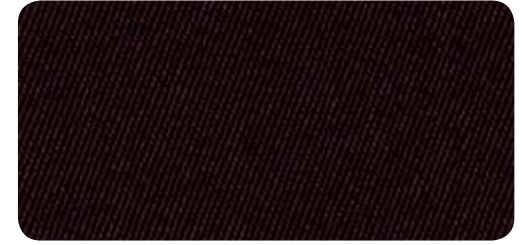

Hood, brown

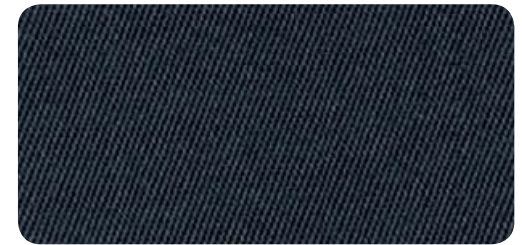

Hood, grey

| Solid paint finishes



Amalfi white

| Metallic paint finishes



Ice silver, metallic

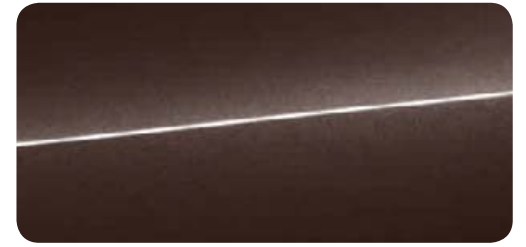

Beluga brown, metallic



Brilliant red

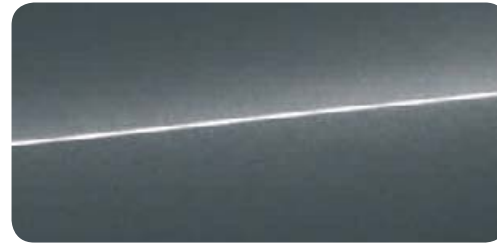

Monsoon grey, metallic



Glacier white, metallic

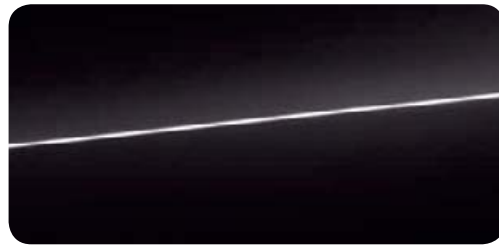

Brilliant black

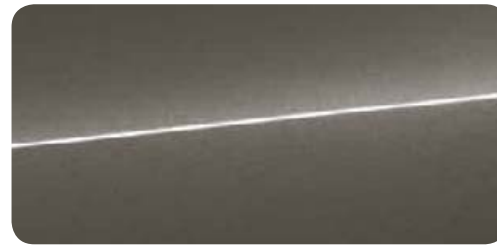

Dakota grey, metallic

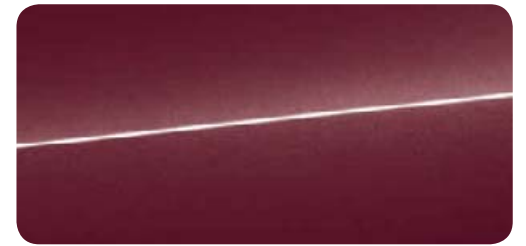

Shiraz red, metallic

| Pearl effect paint finishes



Scuba blue, metallic



Misano red, pearl effect



Sepang blue, pearl effect*
Only available for S3 Sedan

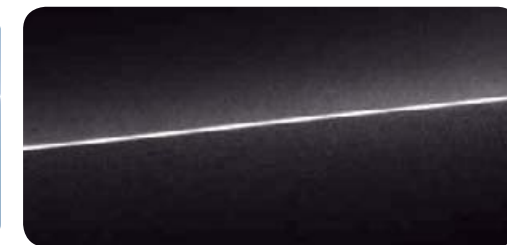

Panther black, crystal effect
Only available for S3 Sedan

| Crystal effect paint finishes



Lotus grey, metallic



Phantom black, pearl effect

| Audi exclusive



Audi exclusive customised paint finishes*
From quattro GmbH

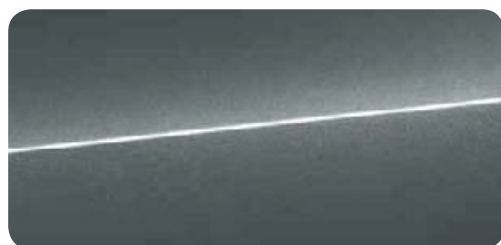

Daytona grey, pearl effect
Only available in conjunction with S line sport package

*For information on when this feature will be available, please contact your Audi partner.



The perfect connection between an Audi and the road: Audi wheels and tyres.

Audi tests its wheels and tyres especially carefully, to be sure you have a good feel for the road from the outset. Before a tyre can become an Audi tyre, it has to undergo a series of tests. This is the only way of guaranteeing that each tyre meets Audi's high quality standards and is perfectly tailored to each specific vehicle. It means you can be sure that both tyre and wheel offer maximum quality, service life and safety. Whichever design you choose.



**You have to suffer a little,
to be this beautiful.**

When our experts test the quality of genuine Audi wheels, they are just as innovative as our designers. Intense heat, high humidity, strong sunlight – the number of possible tests is almost limitless. The most extreme endurance test, however, is the copper accelerated salt spray test, or CASS for short. Here, wheels damaged by simulated stone impacts prior to the test are then sprayed with this extremely corrosive solution over a period of several days. They must withstand all these challenging conditions without any noticeable deterioration to ensure that, even after covering many kilometres, you remain just as delighted with the design of your genuine Audi wheels as you were on the very first day.

The illustration shows the cast aluminium wheel in 5-arm parabola design with gloss turned arms available for the Audi A5, Audi A7 and Audi A8.

| Wheels



Steel wheels, including full wheel covers
size 7 J x 16 with 205/55 R 16 tyres¹



Cast aluminium wheels in 5-arm design
size 7.5 J x 17 with 225/45 R 17 tyres¹



Cast aluminium wheels in multi-spoke design
contrasting grey, partly polished,
size 8 J x 18 with 225/40 R 18 tyres¹



Cast aluminium wheels in 10-spoke design
size 7 J x 16 with 205/55 R 16 tyres¹



Cast aluminium wheels in 5-spoke star design
size 7.5 J x 17 with 225/45 R 17 tyres¹



Cast aluminium wheels in 5-parallel-spoke design (S design),
partly polished, size 8 J x 18 with 225/40 R 18 tyres¹
(only available for S3 Sedan or in conjunction
with S line sport package)



Cast aluminium wheels in 15-spoke Y design
size 7 J x 16 with 205/55 R 16 tyres¹



Cast aluminium wheels in 10-spoke dynamic design
size 7.5 J x 17 with 225/45 R 17 tyres¹



Cast aluminium wheels in 5-twin-spoke star design (S design)²
contrasting grey, partly polished,
size 8 J x 19 with 235/35 R 19 tyres¹
(only available for S3 Sedan)

| Audi exclusive



Audi exclusive cast aluminium wheels in 5-arm rotor design in matt black, gloss turned finish size 8 x 18 with 225/40 R 18 tyres¹.
From quattro GmbH



Audi exclusive cast aluminium wheels in 10-spoke design in matt titanium look, gloss turned finish³ size 8 x 18 with 225/40 R 18 tyres¹.
From quattro GmbH



Audi exclusive cast aluminium wheels in 5-arm structured design size 8 x 18 with 225/40 R 18 tyres¹.
From quattro GmbH



Audi exclusive cast aluminium wheels in 5-arm wing design in glossy titanium look, gloss turned finish² size 8 J x 19 with 235/35 R 19¹ tyres¹.
From quattro GmbH



Audi exclusive cast aluminium wheels in 10-spoke design³ size 8 x 18 with 225/40 R 18 tyres¹.
From quattro GmbH



Audi exclusive cast aluminium wheels in 5-V-spoke design in matt titanium look, gloss turned finish^{2,3} size 8 J x 19 with 235/35 R 19 tyres¹.
From quattro GmbH

| Winter wheels



Steel winter wheels including full wheel covers⁴ size 6.5 J x 16 with 205/55 R 16 tyres¹, permissible top speed 210 km/h, can be fitted with snow chains



Cast aluminium winter wheels in multi-spoke star design size 8 J x 18 with 225/40 R 18 tyres¹, permissible top speed 240 km/h, cannot be fitted with snow chains



Cast aluminium winter wheels in 10-spoke design size 7 J x 16 with 205/55 R 16 tyres¹, permissible top speed 210 km/h, cannot be fitted with snow chains



Cast aluminium winter wheels in 5-arm design size 6.5 J x 17 with 205/50 R 17 tyres¹, permissible top speed 210 km/h, can be fitted with snow chains

¹You will find specifications on the technical characteristics of tyres on page 114. ²Only available for engine models from 92 kW and only in conjunction with sport suspension or Audi magnetic ride (S3 Sedan: only in conjunction with Audi magnetic ride). ³For information on when this feature will be available, please contact your Audi partner. ⁴Including full wheel cover for vehicles with aluminium summer wheels.

Premium quality you can rely on.

You have a special place in your Audi. Exclusive comfort can be felt on the front and back seats: thanks to high-quality materials and first-class workmanship. Whether you decide on standard seats with cloth or leather upholstery or you prefer sport seats or S sport seats with stable lateral support for dynamic driving: you're sitting in the right place.



Standard seats, front 1

The image shows standard seat, front, in Milano leather, pashmina beige.

The model-specific standard and optional equipment can be found in the index from page 118 onwards.



Sport seats, front [2]

The image shows sport seat, front, in rallye cloth, black/silver.



S sport seats, front [3]

The image shows S sport seat, front, in fine Nappa leather, black.

| Cloth



Marathon cloth, black

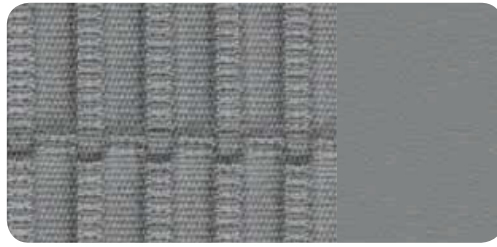

1 Regatta cloth/mono.pur, titanium grey

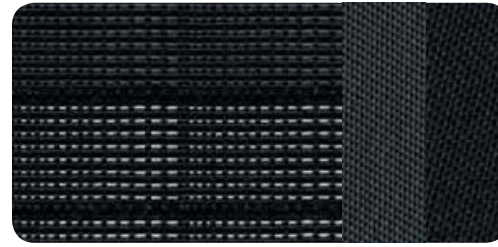

1 Rallye cloth, black/black

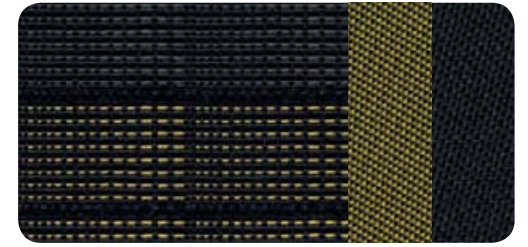

2 Rallye cloth, black/yellow

2



Marathon cloth, titanium grey



1 Regatta cloth/mono.pur, pashmina beige

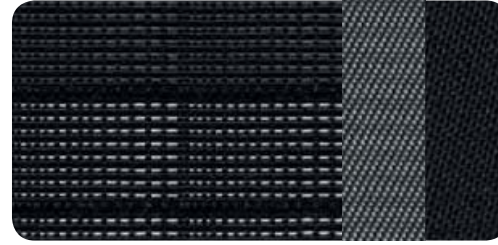

1 Rallye cloth, black/silver

2



Regatta cloth/mono.pur, black



1 Regatta cloth/mono.pur, chestnut brown



1 Rallye cloth, black/blue

2

| Cloth/Leather

| Leather

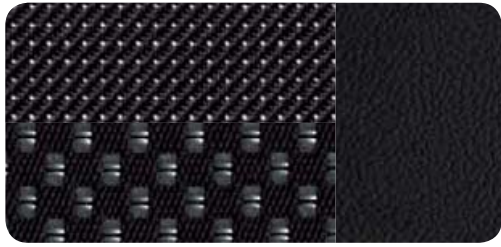

Biathlon cloth/leather, black
Only available in conjunction with S line sport package

2



Milano leather, pashmina beige

1



Milano leather, chestnut brown

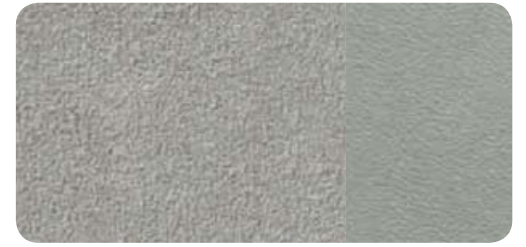

Alcantara/leather, lunar silver
Only available for S3 Sedan

2



Trophy cloth/leather, black
Only available for S3 Sedan

2



Milano leather, black

1

2



Alcantara/leather, black



Perforated Alcantara/Leather, black
Only available in conjunction with S line sport package

2

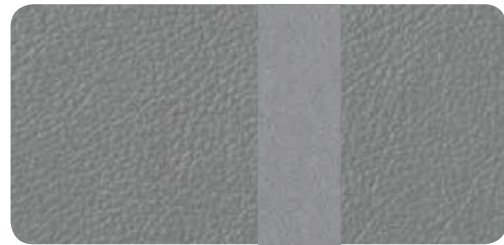

Milano leather, titanium grey

2

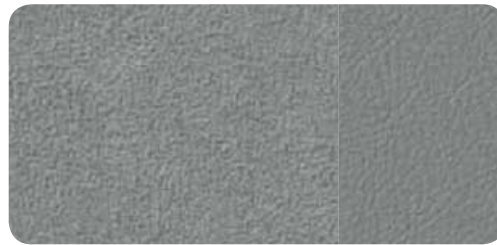

Alcantara/leather, titanium grey



Fine Nappa leather, black
Only available for S3 Sedan or in conjunction with S line sport package

2

3

| **Leather**

Fine Nappa leather, lunar silver
Only available for S3 Sedan

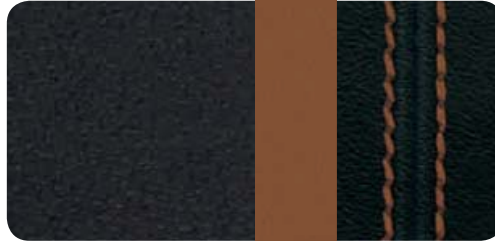
| **Audi design selection**

Audi design selection lasso brown

| **Audi exclusive**

Audi exclusive leather upholstery and trim¹ **1** **2** **3**
Individual choice of colour for leather/stitching.
From quattro GmbH

| **Seat options**

- 1** Standard seats, front
- 2** Sport seats, front
- 3** S sport seats, front



Audi design selection parade red
Only available for S3 Sedan

2

| Seat upholstery

Marathon cloth

for standard seats, front: seat centre panel in marathon cloth and seat side bolsters, head restraints, door/side panel trim inserts and front centre armrest (if ordered) in single-colour cloth

Regatta cloth/mono.pur

for standard seats, front: seat centre panel in regatta cloth and seat side bolsters, head restraints, door/side panel trim inserts and front centre armrest (if ordered) in mono.pur synthetic leather

Rallye cloth

for sport seats, front: seat centre panel in rallye cloth, colour-coordinated cloth in shoulder area and seat side bolsters, head restraints, door/side panel trim inserts and front centre armrest (if ordered) in single-colour cloth

Trophy cloth/leather

for sport seats, front, seat centre panel in trophy cloth, black, seat side bolsters and head restraint centre panel in black leather with contrasting stitching, shoulder area in trophy cloth black/parade red, front centre armrest in synthetic leather; with S3 embossing on the front-seat backrests

Alcantara/leather combination

Exclusive, sporty look for sport seats. High seating comfort and a good seating climate thanks to rapid temperature equalisation. Particularly hard-wearing, easy to clean and resistant to wear and tear. The Alcantara seat centre panel provides good support, making it especially suitable for dynamic driving styles. The side bolsters made from the finest leather complete the seat.

For sport seats, front: seat centre panel and door/side panel trim inserts in Alcantara; seat side bolsters and head restraint centre panel in leather (for S3 Sedan and S line sport package each with contrasting stitching) and the front centre armrest (if ordered) in synthetic leather. S3 Sedan / S line sport package with S3 / S line embossing on the front-seat backrests. In A3 Cabriolet including heat protection (except for the seat centre panel)

Milano leather

Extremely hard-wearing and durable leather that gives a high-quality impression with its fine, grained surface. Fully penetrated with dye and tanned without the use of chromium, the leather provides outstanding surface protection thanks to the painted coat.

For standard seats, front: seat centre panel and head restraint centre panel in Milano leather, inner seat and backrest side bolsters in velvet leather and front centre armrest (if ordered) and door/side panel trim inserts in synthetic leather.

For sport seats, front: seat centre panel, seat side bolsters and head restraint centre panel in Milano leather, shoulder area in velvet leather and front centre armrest (if ordered) and door/side panel trim inserts in synthetic leather. In A3 Cabriolet including heat protection

Fine Nappa leather

High-quality, supple leather with a balanced lacquer coat. It has air-permeable properties thanks to its natural surface, thereby contributing to a pleasant seating climate. The leather is extremely hard-wearing, durable and resistant to fading. Its fine grain underlines its exclusive character.

For sport seats, front: seat centre panel, seat side bolsters, head restraint centre panel and front centre armrest (if ordered) in fine Nappa leather, shoulder area in velvet leather with contrasting stitching and door/side panel trim inserts in synthetic leather. S3 Sedan with S3 embossing, S line sport package with S line embossing on the front-seat backrests. In A3 Cabriolet including heat protection.

For S sport seats, front: seat centre panel, seat side bolsters, head restraint centre panel and front centre armrest (if ordered) in fine Nappa leather, shoulder area in fine Nappa leather embroidered with contrasting stitching and door/side panel trim inserts in synthetic leather. S3 Sedan with S3 embossing, S line sport package with S line embossing on the front-seat backrests. In A3 Cabriolet including heat protection.

| Audi design selection

Audi design selection lasso brown

Exclusive combination of fine interior colours and special materials. The Audi design selection package contains the following features:

- seat centre panel, seat side bolsters and head restraint centre panel of sport seats, front in black Milano leather with contrasting stitching in lasso brown
 - shoulder area and door/side panel trim inserts in lasso brown velvet leather
 - front centre armrest (if ordered), knee pads and armrests in the doors in black leather with contrasting stitching in lasso brown
 - sport leather steering wheel in black 3-spoke design with contrasting stitching in lasso brown
 - gear or selector lever knob in black leather and gear or selector lever gaiter in black leather with contrasting stitching in lasso brown
 - floor mats with piping in lasso brown
-

Audi design selection parade red

Exclusive combination of fine interior colours and special materials. The Audi design selection package contains the following features:

- seat centre panel, seat side bolsters and head restraint centre panel of sport seats, front in black fine Nappa leather with contrasting stitching in parade red
- shoulder area in parade red velvet leather
- door trim inserts in black velvet leather
- front centre armrest, knee pads and armrests in the doors in black leather with contrasting stitching in parade red
- sport leather steering wheel in black 3-spoke design with contrasting stitching in parade red
- gear or selector lever knob in black leather and gear or selector lever gaiter in black leather with contrasting stitching in parade red
- floor mats with piping in parade red
- with S3 embossing on the front-seat backrests

| Leather packages

Audi exclusive Alcantara/fine Nappa leather upholstery and trim (package 1)^{1,2}

for sport seats, front, seat side bolsters, head restraints and front centre armrest in fine Nappa leather, seat centre panel, door/side panel trim inserts and front shoulder area in Alcantara, optionally available with coloured stitching. S3 Sedan with S3 embossing on the front-seat backrests. The package includes floor mats with leather piping. Individual choice of colour for the leather and the decorative stitching from the range of Audi exclusive colours.

Audi exclusive fine Nappa leather upholstery and trim (package 1)^{1,2}

seat centre panel, seat side bolsters, head restraints and front centre armrest in fine Nappa leather for standard seats, front, and S sport seats, front. Door/side panel trim inserts in fine Nappa leather. Shoulder area of sport seats, front, in velvet leather and for S sport seats, front, in embroidered fine Nappa leather, optionally available with coloured stitching. S3 Sedan with S3 embossing on the front-seat backrests. The package includes floor mats with leather piping. Individual choice of colour for the leather and the decorative stitching from the range of Audi exclusive colours.

Audi exclusive extended leather upholstery and trim^{1,2}

leather-covered armrests in the doors and knee pads in the centre console.

Extended interior elements mono.pur

The material of the interior underlines the sophisticated character of the vehicle interior. Visual accentuation of the knee pads and armrests in the door through their synthetic leather design.

¹For information on when this feature will be available, please contact your Audi partner. ²From quattro GmbH.

Experience fascination. Down to the last detail.

Exclusive ambience is a question of style. Your style. A style you can refine right down to the last detail. Create tangible accents with high-quality Audi inlays. Take pleasure in the fine aluminium detailing for dashboard and door trims. Partly embossed, partly brushed. Harmoniously integrated into the interior. Exuding a sporty attitude. Creating an ambience that accentuates the dynamic image of your Audi in the interior too.



| Inlays



Micrometallic, silver



Matt brushed aluminium
Only available for S3 Sedan or in conjunction with S line sport package

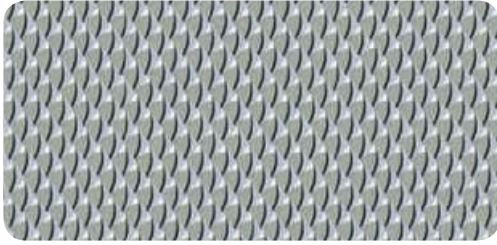

3D-design "Optic"



3D-design "Black"
Only available for S3 Sedan or in conjunction with S line sport package



Aluminium mistral, silver¹



Aluminium mistral, bronze²

¹ Not available for regatta cloth/mono.pur, pashmina beige or Milano leather, pashmina beige. ² Only available in conjunction with regatta cloth/mono.pur, pashmina beige or Milano leather, pashmina beige.

| Technology



Audi drive select

allows vehicle characteristics to be set in the available modes: auto, comfort, dynamic, efficiency as well as – in conjunction with MMI radio or MMI navigation plus with MMI touch – individually by adjusting the power steering assistance, accelerator and gear changing characteristics (S tronic) and additional optional equipment. The efficiency mode shifts specifically selected systems to a consumption-improved basic setting.



Audi magnetic ride

Improved driving comfort and driving dynamics thanks to the regulation of the damping forces based on the driving situation. Adaptive damper system with 3 individual selections of suspension settings (auto/comfort/dynamic). Can be set via Audi drive select (option for TFSI and TDI engines from 103 kW). Including sport suspension lowered by 15 mm compared with the dynamic suspension.

Start-stop system

helps to reduce fuel consumption and CO₂ emissions by automatically switching off the engine when standing, e.g. at traffic lights. The engine is restarted as soon as the clutch is pressed (manual transmission) or the footbrake is released (S tronic). May be deactivated using a switch at any time

Recuperation

economises on fuel through brake energy recuperation. Kinetic energy is converted into usable electrical energy by increasing the generator voltage when the vehicle is coasting or braking and reducing the voltage during a subsequent acceleration

Audi cylinder on demand

This technology allows a significant reduction in fuel consumption and CO₂ emissions. If the full power of the 4 cylinders are not required in the partial-load range or when coasting, the intake and outlet valves of 2 cylinders are automatically closed and their ignition and fuel injection are switched off.

Diesel particulate filter, additive-free

The automatic filter system reduces soot particle emissions in all diesel models.

Audi TDI clean diesel (nitrogen oxide storage catalytic converter)

significantly reduces nitrogen oxides in the exhaust flow, which leads to lower exhaust emissions. Meets the strict EU6 emission standard valid as of 2014. In addition to the standard equipment with catalytic converter and diesel particulate filter, the model with TDI clean diesel has a maintenance-free nitrogen oxide storage catalytic converter.

Manual transmission

all-synchromesh 6-speed manual transmission with hydraulically activated single-disc dry clutch with asbestos-free linings and dual-mass flywheel

S tronic®

6- or 7-speed dual-clutch transmission allowing faster gear changing without any perceptible break in propulsive power. In automatic mode, programmes D (Normal) and S (Sport) can be selected. The S tronic can be manually operated using the optional shift paddles behind the steering wheel or the selector lever. Includes hill hold assist.

When in “D” gear, coasting mode allows an anticipatory driving style and helps to reduce fuel consumption by automatically disengaging when the accelerator is released. It is automatically re-engaged when the footbrake or the accelerator is depressed. Can be activated in Audi drive select efficiency mode

Front-wheel drive

distributes the drive forces to the front wheels according to the driving situation. With Electronic Differential Lock (EDL) through intervention of the brake system on both driven wheels, Anti-Slip Regulation (ASR) and Electronic Stabilisation Control (ESC) with brake assist

quattro®

Impressive traction and driving safety through the distribution of the drive forces to each individual wheel according to the driving situation. With wheel-selective torque control. The drive force is distributed by means of the electronically controlled multi-plate clutch on the rear axle and targeted braking actions on the part of the Electronic Differential Lock (EDL).

Dynamic suspension

Sporty, dynamic driving characteristics thanks to impressive driving dynamics and agile handling. Front axle with McPherson struts with lower wishbones, aluminium subframes and tubular stabiliser. 4-link rear axle with separate spring/damper arrangement, subframe and tubular stabiliser. Lightweight compound link rear suspension for 1.6 TDI (77 kW)

Sport suspension

More direct contact with the road and sporty handling thanks to a body lowered by 15 mm and stiffer springs and damper tuning

S line sport suspension

more dynamic spring/damper setting and vehicle lowered by 10 mm compared with the sport suspension or by 25 mm compared with the dynamic suspension

Electromechanical power steering

combines precision and comfort with especially energy-saving technology. With its specific characteristic curve, the electromechanical steering with speed-sensitive servo-assistance is tight and highly precise at high speeds and smooth when parking and manoeuvring.

Progressive steering

enhances the driving dynamics and driving comfort thanks to more direct steering characteristics (e.g. on winding rural roads or when turning) and reduced steering effort (e.g. when parking and manoeuvring). Impressive driving characteristics thanks to a variable steering ratio based on the steering angle and speed-sensitive steering assistance. Can be set via Audi drive select (auto/comfort/dynamic)

Secondary collision brake assist

Following an accident, uncontrolled continued vehicle motion is prevented in certain situations. In these cases secondary collisions can be avoided.

Electromechanical parking brake

includes parking brake function when stationary, drive-off assistance function through automatic release when driving away and maximum deceleration action while driving acting on all 4 wheels

| Lights



Headlights

Uniform illumination of the road with halogen headlights using free-form technology with clear glass cover, electric headlight range control and parking light function. Integrated daytime running lights

Headlight cleaning system

for excellent illumination and improved visibility thanks to reduced scatter. Uses water and high pressure

Light/rain sensor

Automatic control of lights-on function, windscreen wipers and coming home/leaving home function. Delayed switch-off/automatic switch-on of main headlights, rear and number plate lights, optional front fog lights and with xenon plus the LED daytime running lights when parking/opening the vehicle. Windscreen with grey strip along the top edge

High-beam assist

Depending on the traffic situation, the high beam automatically adjusts to dipped beam and vice versa. Working within system limits, automatically detects the headlights of oncoming traffic, the rear lights of other road users and built-up areas.



Xenon plus including headlight cleaning system

Intensive road illumination, good uniformity and range thanks to headlights with durable gas discharge technology for dipped and high beam. Automatic dynamic headlight range control that prevents oncoming traffic from being dazzled. Integrated homogeneous LED daytime running light strip and headlight cleaning system. Including LED rear lights



Front fog lights

halogen, integrated harmoniously into the front apron

Variable headlight range control

The range of the headlights is continuously varied between dipped and high beam to suit ambient conditions, ensuring that the headlights provide good visibility without dazzling other road users. A camera on the interior mirror registers sources of light from other road users working within system limits.



LED headlights

Near daylight illumination of the road for increased safety and comfort with low required energy and a long service life. Excellent recognition by other road users thanks to the striking Audi lighting pattern with daytime and night-time design. Consists of dipped beam, high beam, combined daytime running light, position light and indicator function, static turning light as well as all-weather light and motorway light function all using LED technology with automatically increased headlight range from a speed of approximately 110 km/h. The headlights also have different light distribution modes which are activated depending on the vehicle speed: motorway light and country light. In addition, the vehicle support based on navigation data allows these light distribution modes to be controlled with the aid of stored route data from the optional MMI navigation plus with MMI touch. In this configuration, the convenient functions of the lighting assistant are additionally supplemented by the intersection light with a broad spread of light from the front lighting system and by the travel mode with GPS-assisted switching between right- and left-hand drive modes. Including LED rear lights

adaptive light

pivoting xenon headlights, improved lateral illumination due to dynamic cornering light (speed range approx. 10–110 km/h) and static turning light. According to the situation, the motorway light and country light are activated depending on the vehicle speed. In conjunction with the optional MMI navigation plus with MMI touch, additional GPS-based vehicle support with the aid of stored route data for the intersection light and travel mode



Rear lights

with reversing lights in white and rear fog lights. Including third high-level brake light and rear number plate lights using LED technology

Adaptive brake light

Brake light flashes in case of emergency stop to warn following traffic. In addition, the hazard warning light is automatically activated when the vehicle comes to a stop.



LED rear lights

Earlier recognition by the driver behind due to the faster activation of brake lights, tail lights, rear number plate lights and indicators using LED technology with low power consumption. With reversing lights and rear fog lights. New design language with homogeneous, three-dimensional floating effect for the light guide

| Lights

Lighting package

Anti-glare lighting in energy-saving and long-lasting LED technology, comprising:

- interior lights in front and rear, including reading lights; for A3 Cabriolet interior lights in front including capacitive reading lamps
- reflected lighting for the centre console
- illuminated vanity mirrors for driver and front passenger
- illuminated cup holders
- entrance lighting, front footwell lighting in front (for A3 Sedan/S3 Sedan also in rear) as well as illuminated inside door handles
- luggage compartment light
- active door reflectors (light bulb)

| Design

Exhaust tailpipes

single for the 1.6 TDI (77 kW), 2 tailpipes on the left for other petrol and diesel engines

Model/technology name

on the luggage compartment lid, quattro logo (on quattro models) in the Singleframe and on the luggage compartment lid as well as on the dashboard on the passenger side; on request also available without the model/technology name on the rear

Gloss package

Window slot and door frame trim as well as side window surrounds in anodised aluminium

Aluminium-look exterior

Surfaces of the windscreen frame, window slot trims and cover trim in anodised aluminium

Aluminium look in the interior

Elements in aluminium look on air vents, glove compartment, mirror adjustment switch, frame around the inside door handle, window control switches, coin box as well as on the control buttons for the parking brake and – if ordered – the hold assist.

| Operation



Multifunction leather steering wheel in 4-spoke design

Multifunction operating concept for operation of the available infotainment features. With full-size airbag, adjustable for height and reach, includes gear or selector lever knob in leather. With optional shift paddles for manually changing gears with S tronic



Sport leather steering wheel in 3-spoke design

with full-size airbag, adjustable for height and reach, includes gear or selector lever knob in leather



Multifunction sport leather steering wheel in 3-spoke design, flattened at the bottom

Multifunction operating concept for operation of the available infotainment features. With full-size airbag, adjustable for height and reach, includes gear or selector lever knob in leather. With optional shift paddles for manually changing gears with S tronic

Steering wheel in 4-spoke design

with full-size airbag, adjustable for height and reach

Leather steering wheel in 4-spoke design

with full-size airbag, adjustable for height and reach, includes gear or selector lever knob in leather

Multifunction sport leather steering wheel in 3-spoke design

Multifunction operating concept for operation of the available infotainment features. With full-size airbag, adjustable for height and reach, includes gear or selector lever knob in leather. With optional shift paddles for manually changing gears with S tronic

Audi exclusive leather steering wheel rim*

Leather covering of steering wheel rim available in all Audi exclusive colours. Individual choice of colour for stitching in various Audi exclusive colours with specific Audi exclusive seam detail

Audi exclusive leather controls*

Leather covering of steering wheel rim, gear or selector lever and gear or selector lever gaiter available in all Audi exclusive colours. Individual choice of colour for stitching in various Audi exclusive colours. Stitching on the steering wheel rim with specific Audi exclusive seam detail.

Gear lever knob in Audi exclusive aluminium***Remote control key**

unlocks and locks doors, luggage compartment lid and tank flap. With convenient closing/opening of the windows

Convenience key

Access and drive-away authorisation system where the key needs only to be carried with you. The engine is started and switched off via the engine start-stop button. The vehicle is locked and unlocked from outside via sensors on the driver and front-passenger door handles. Can also be opened from the luggage compartment lid.

Luggage compartment lid, automatically opening

The luggage compartment lid automatically swings open when the luggage compartment is opened via the remote control key or by activating the soft-touch release on the luggage compartment lid.

| Comfort**Panoramic glass sunroof**

Electrical activation to raise and open the front glass section, opens and closes automatically. With tinted glass insert and infinitely adjustable sun shield as well as convenience closing from outside via the vehicle key. Creates a pleasant bright ambience thanks to the extra-large glass area. Good acoustics when the roof is raised or fully opened, integrated wind deflector reduces wind noise when the roof is opened.

**Wind deflector**

reduces draughts in the interior. Simple operating concept and easy attachment

Acoustic windscreen

Heat-insulating glass with improved acoustic insulating value for the windscreen

Dark-tinted windows (privacy glazing)

Dark-tinted rear window, rear door windows and rear side windows

Hood

Fully automatic hood in black made from insulated, 3-ply fabric. The hood is opened and closed by unlocking and locking the door lock with the key. The hood opens in 17 seconds and closes in 18 seconds. The hood can be operated at up to 50 km/h

Acoustic hood

Operation and design as with fully automatic hood made from insulated 3-ply fabric. Additional improvement of interior noise levels thanks to improved material thickness and binding techniques combined with additional insulation. Available in 3 colours

Convenience entry

Easy access to the rear compartment thanks to enhanced front-seat folding function

Front-passenger seat, height-adjustable

front-passenger seat, manually height-adjustable

Driver seat, electrically adjustable

with electric adjustment of seat height, fore/aft position, seat angle and backrest angle for the driver seat. Front-passenger seat with manual adjustment

Front seats, electrically adjustable

with electric adjustment of seat height, fore/aft position, seat angle, backrest angle

4-way lumbar support for the front seats

electric, with horizontal and vertical adjustment

Ventilation system and heating

ventilates and heats up the vehicle passenger compartment. 4 round vents in the dashboard that can be individually adjusted to provide directed or diffuse air flow, footwell vents at the front and rear and defroster nozzles for the windscreen and side windows

**Manual air conditioning**

cools or heats up the vehicle passenger compartment. Manual air distribution, manual recirculation mode, infinitely variable blower and particulate filter. 4 round vents in the dashboard that can be individually adjusted to provide directed or diffuse air flow, footwell vents at the front and rear and defroster nozzles for the windscreen and side windows

| Comfort

**Deluxe automatic air conditioning**

Separate temperature control for driver and front passenger with indirect ventilation through defroster nozzles and sunlight-dependent control. Electronically controls the air temperature, flow rate and distribution. Automatic recirculation mode by means of air quality sensor, combined filter and rear vents. With humidity sensor and key-coded settings

**Auxiliary heating/ventilation**

The auxiliary heating warms up the interior and keeps the windows free from ice – without starting the engine. The parking ventilation supplies fresh air and lowers the interior temperature. With timer and departure time programming. An intelligent control function calculates the heating duration in a time and energy-efficient manner. Separate radio-operated remote control with illuminated display

**Centre armrest, front**

adjustable angle, can be adjusted lengthways

**Mobile phone/key holder**

with a separate storage compartment for mobile phone and vehicle key. Cup with chrome ring installed in the centre console

Seat heating, front

heats the seat and backrest centre panel, for leather upholstery and trim and sport seats also heats the seat side bolsters. For driver and front-passenger seat individually adjustable in 3 stages

Headroom heating

heats the front headroom. Adjustable in 3 stages. Air vents on the front-seat backrests

Heat protection

A special colour pigmentation prevents the leather from being strongly heated up by sunlight. Infrared radiation is reflected. This can lower the surface temperature of the leather by up to 20 °C. Typical leather properties remain unaffected. With Milano leather and fine Nappa leather, the seat cushions and front-seat backrests have heat protection; with Alcantara leather the front-seat backrests only.

Cigarette lighter and ashtray

removable. Chrome-plated cover with Audi rings. Cigarette lighter replaces the standard 12V socket in the centre console

| Transport

**Storage and luggage compartment package**

storage nets on the backs of the front-seat backrests and in the front-passenger footwell and 12V socket in the rear centre console. For A3 Sedan/S3 Sedan including additional storage compartment under the rear seat bench (including two high-visibility vests). In the luggage compartment, LED luggage compartment light, net in the side trim, luggage compartment net, 12V socket. For A3 Sedan/S3 Sedan with additional bag hooks

Storage compartments

storage compartment in the door/side panel trims, in the centre console and under the right front seat

Rear seat backrest, folding

can be split-folded 60:40 (A3 Cabriolet 50:50) or fully. For A3 Cabriolet with remote backrest release in luggage compartment

**Through-loading facility**

Extended loading option for the practical transportation of long objects. Includes rear centre armrest with cup holders and storage compartment

Ski/snowboard bag

for the practical transportation of long items, e. g. up to 4 pairs of skis or 2 snowboards. Removable and secured by a strap

Reversible mat

for covering the entire luggage compartment even when the rear seat backrest is folded down. Velour on one side, rubber on the other

Hood compartment, variable

with lowering hood tray which lowers automatically when the hood is opened if sufficient room is available in the luggage compartment. For loading, the hood tray can be lifted when the hood is closed

Trailer towing hitch

removable and lockable, with sphere bar and ball head made from forged steel. The 13-pin socket can be swivelled out of sight behind the bumper skirt. When removed, the trailer towing hitch can be stored in the spare wheel well. Trailer stabilisation via the Electronic Stabilisation Control (ESC)

| Safety

Exterior mirrors with integrated LED indicators

electrically adjustable with aspherical mirror glass on the left, convex on the right. Body-coloured housing

Additional options:

heated

including heated windscreen washer jets

heated and electrically folding

including heated windscreen washer jets and automatic kerb-side function for the exterior mirror on the passenger side

heated, electrically folding and automatically dimming on the driver side

including heated windscreen washer jets and automatic kerb-side function for the exterior mirror on the passenger side

The automatic kerb-side function tilts the exterior mirror on the passenger side downwards when reverse gear is engaged, giving the driver a better view of the kerb.

Interior mirror, dimming

choice of:

automatically dimming

with light/rain sensor and grey strip

Anti-theft alarm

monitors doors, bonnet and luggage compartment lid and interior. Interior monitoring system which can be switched off and signal horn which is independent of the vehicle electrical system. With tow-away protection via angle of inclination sensors (can be switched off).

Airbags

Full-size airbags for driver and front passenger and knee airbag on the driver side. Includes front-passenger airbag deactivation switch in conjunction with ISOFIX child seat mounting

Side airbags, front, and head airbag system

protects front and outer rear seats in the event of a side impact. Front side airbags integrated into the seat backrests and, for A3 Sedan/S3 Sedan, an additional head airbag system that unfolds over the entire length of the side windows. For A3 Sedan/S3 Sedan optionally available with side airbags for the rear

Integrated head restraint system

increases safety and reduces the danger of whiplash. In the event of a rear-end collision, the design of the front seat better restrains the upper torso and provides stronger support for the head than conventional systems.

Active roll-over protection

protects passengers in the back by means of an automatically triggered protective system behind the rear head restraints

ISOFIX child seat mounting for the front-passenger seat

with front-passenger airbag deactivation switch. For A3 Sedan and S3 Sedan with electric child-proof lock for the rear doors

ISOFIX child seat mounting and Top Tether for the outer rear seats

standard mounting for practical attachment of ISOFIX child seats. Including additional attachment point (Top Tether). Recommended child seats can be obtained from your Audi partner.

Assistance systems



Park assist with selective display¹

Virtually automatic steering process during parking. Uses ultrasonic sensors to search for suitable bay and kerb-side parking spaces. The ideal parking path is calculated for bay parking spaces, and the ideal path for leaving the parking space is additionally calculated for kerb-side parking spaces. The steering action is performed by the system. The driver must accelerate and apply the brakes as well as monitor the parking process. The display of surroundings warn the driver, depending on the steering angle, of any obstacles at the side of the vehicle by displaying the lane in conjunction with MMI navigation plus with MMI touch. Assisted parking is now even possible in smaller parking spaces and bend areas. Parking in several moves is supported. Can optionally be ordered with reversing camera



Reversing camera¹

Image of area behind the vehicle shown on the MMI display, with dynamic display modes showing the path calculated based on steering angle. Auxiliary lines and guidelines as well as identification of the point at which to apply opposite lock when parallel parking. Reversing camera integrated discreetly in the handle strip of the luggage compartment lid

Parking system, rear¹

makes reverse parking easier within system limits by indicating acoustically how far away the vehicle is from an object detected behind the vehicle. Measured by ultrasonic sensors integrated discreetly in the bumpers

Parking system plus with selective display¹

Acoustic and visual front and rear parking system assists with parking and manoeuvring. With selective visual view in the MMI display of the distance to detected objects based on the current bend radius and direction of travel. A white segment indicates a detected obstacle outside the driving path. Red segments represent obstacles in the driving path. The virtual lane display in conjunction with MMI navigation plus with MMI touch additionally provides guidelines at the sides which are calculated in advance depending on the current angle of turn, thus supporting comfortable parking and leaving of parking spaces. Measured by ultrasonic sensors integrated discreetly in the bumpers. Can optionally be ordered with reversing camera

Cruise control¹

at speeds of 30 km/h and above, the system keeps the set speed constant, provided that engine power and engine braking effect permit it. Operated via separate steering column stalk. Set speed displayed in driver information system

Audi pre sense basic¹

initiates preventive measures for your protection and that of other passengers if required. These include: tensioning the front seat belts, closing the windows and – if fitted – the panoramic glass sunroof. Categorises driving situations by networking different vehicle systems



Audi active lane assist¹

helps you to keep in lane by means of gentle steering intervention. Within system limits, the lane compliance assistant is triggered when the driver starts to cross detected lane markings without activating an indicator. The system functions within a speed range of 60 to 250 km/h. Steering vibration can be adjusted if the driver wishes. Camera-based traffic sign recognition is included in conjunction with MMI navigation plus with MMI touch. Includes high-beam assist, which automatically switches the high beam on or off according to the driving situation

Audi pre sense front¹

Enhanced brake assist warns of any imminent threat of collision with the vehicle in front. Can initiate partial braking action or boost the driver's braking action if necessary. In addition, full braking action is initiated at speeds below 30 km/h if there is danger of collision with a stationary or moving vehicle in order to reduce the speed of the collision or to avoid the collision if possible.



Audi side assist¹

Warns by means of an LED display on the relevant exterior mirror of any situations assessed as critical for lane-changing. 2 wheel sensors detect vehicles approaching from behind and measure the distance and the difference in speed. The lane change assistant functions from 30 km/h to 250 km/h.



adaptive cruise control including Audi pre sense front¹

detects vehicles ahead with the aid of radar sensors. The distance from the vehicle ahead is kept more or less constant by braking or accelerating, within the control range. Control range for manual transmission 30–150 km/h, S tronic 0–150 km/h and with optional assistance package and S tronic extended to 200 km/h. Braking to a stop and automated restart at driver's request possible with S tronic. 4 distance levels/driving modes can be selected (efficiency, comfort, dynamic and auto). Including Audi pre sense front



Camera-based recognition of traffic signs^{1,2}

Traffic sign recognition for overtaking bans and speed limits as well as temporary speed limit displays within the viewing range of the camera. Shown in the display of the instrument cluster. Situation-based evaluation for wet conditions, speed limits displayed depending on the time of the day, road works and trailer use³. Limits not detected by the camera are evaluated with the aid of Audi connect navigation data and displayed in the instrument cluster. The system is purely for your information; no action is taken and no warning is given if the displayed speed is exceeded.

Assistance package¹

combines the following assistance systems:

- parking system plus with selective display or, on request, park assist with selective display, each with optional reversing camera
- Audi active lane assist
- adaptive cruise control with extended control range (manual transmission 30–200 km/h, S tronic 0–200 km/h)

The systems of the assistance package mutually complement and support each other.

| Infotainment



Driver information system with colour display

shows the information of the driver information system on a high-resolution colour display with an even better overview and legibility. Added information display option to complement – if ordered – adaptive cruise control and camera-based recognition of traffic signs

Driver information system

displays a host of useful vehicle information on a 3.5" monochrome display in the driver's direct field of vision. The attention assist provides a warning in the driver information system and via acoustic signal if anything indicates that the driver is starting to become inattentive. The system is active between 65 and 200 km/h and can be deactivated. An integrated efficiency program provides consumption figure overviews.



Audi radio

- pop-up control panel with 3.4-inch display
- CD player (MP3 and WMA capable) and AUX-IN connection
- 6 preset buttons for an overall 24-station memory, FM (VHF) and AM (MW) reception incl. phase diversity and speed-dependent volume control
- 4 speakers at the front, total output 40 watts

¹ Please note: the systems can only work within system limits. They assist the driver with driving tasks. However, the driver remains responsible for driving the vehicle and is required to be attentive. ² Only available for Western Europe. ³ Only applies to factory-fitted trailer towing hitch.

| Infotainment



MMI® Radio

- Integrated MMI control concept, comprising an electrically extending 5.8-inch colour display, separate MMI control panel and car menu
- CD player and SDHC memory card reader (up to 32 GB, both MP3 and WMA capable) and AUX-IN connection
- 50-station memory with dynamic station list, FM (VHF) and AM (MW) reception incl. display of information about the current radio station (e.g. title and artist, if available); phase diversity and speed-dependent volume control
- 8 speakers at the front and rear, total output 80 watts

Digital Audio Broadcasting

Better sound quality according to DAB standard, including DAB+ and DMB audio through the reception of digitally broadcast radio stations¹. Display of additional information accompanying the programme (depending on provision by the respective radio station) in the form of a slide show (e.g. artist and title) and other programme-independent data services (e.g. weather and traffic). In conjunction with MMI navigation plus with MMI touch: permanent search for alternative reception frequencies of the set station via a second DAB tuner and simultaneous updating of the station list



Audi sound system

Impressive sound thanks to 6-channel amplifier with a total output of 180 watts and 10 loudspeakers (A3 Cabriolet with total output of 140 watts and 9 loudspeakers) including a centre speaker in the dashboard and, for the A3 Sedan/S3 Sedan, a subwoofer in the parcel shelf



Bang & Olufsen Sound System

Fascinating surround sound reproduction via 15-channel amplifier with a total output of 705 watts (A3 Cabriolet with 13-channel amplifier with a total output of 625 watts) as well as 14 – or for the A3 Cabriolet, 13 – high-performance loudspeakers, including a centre speaker in the dashboard. The A3 Sedan/S3 Sedan includes a subwoofer in the parcel shelf and the A3 Cabriolet includes two kickbass loudspeakers with an output of 100 watts each. Perfect design experience thanks to the exclusive loudspeaker covers with aluminium applications and the LED lighting accentuating the front woofers. Continuous adaptation of the sound to driving and background noises determined by microphone. Reproduction of 5.1 surround sound possible in conjunction with MMI navigation plus with MMI touch and integrated DVD drive.



Audi music interface²

Portable media players such as Apple iPod, Apple iPhone (music functionality) as well as USB storage media and MP3 players may be used with special adapter cables available from Audi Genuine Accessories. Audi music interface is located in the centre console. Operated via MMI or – if ordered – a multifunction leather steering wheel (for the A3 Sedan/S3 Sedan with voice control). (Part of connectivity package and MMI navigation plus with MMI touch)

Adapter cable set for Audi music interface

consisting of 2 connecting cables to connect Apple iPod/ iPhone as well as data storage devices/media players² with USB port (type A). Other adapter cables are available from Audi Genuine Accessories

Adapter cable set plus for Audi music interface

Depending on the device used, the representation of cover arts and video functions is possible as an added function in conjunction with Apple iPhone and more recent Apple iPod generations².

Navigation package

contains the features of the connectivity package as well as the navigation function and data on an SD card³. Maps are shown on an electrically extending 5.8-inch colour display. Operated via MMI radio or – if ordered – a multifunction leather steering wheel (for the A3 Sedan/S3 Sedan with voice control)



MMI® navigation plus with MMI touch

- hard disc navigation³ including map update service⁴
- electrically extending, high-resolution 7-inch colour display featuring high-quality 3D map display with topographical map colouring, 3D display e.g. of city models, choice of 3 alternative routes, split-screen mode for route information (e.g. TMCpro on route), detailed junction map and lane recommendations, dynamic route guidance (where available)
- context-related entry of letters and numbers via handwriting recognition on touch-sensitive MMI touch control panel integrated in the rotary/push-button control
- selections from the address book can be made and navigation destinations or telephone numbers entered without drivers taking their eyes off the road
- MMI touch makes it easy to move the navigation map
- speed limit display based on navigation data
- country information, e.g. on valid speed limits, motorway sticker requirement when passing the border, etc.
- myAudi special destinations: import of individual point-of-interest (PoI) lists to the vehicle via using myAudi portal
- voice control system with whole-word entry of address (only available for A3 Sedan/S3 Sedan and in conjunction with multifunction leather steering wheel)
- additional arrow display in the driver information system
- radio with triple tuner and phase diversity
- flash memory for music (10 GB)
- DVD drive (MP3, WMA, AAC and MPEG-4 compatible) for music and video DVDs
- 2 SDXC card readers (up to 2 TB)
- Audi music interface
- Bluetooth interface with Bluetooth audio streaming
- 8 passive loudspeakers with a total output of 80 watts
- display of emails and messages (only available for A3 Sedan/S3 Sedan) from mobile phone in selected languages plus read-out function⁵
- use of services supported by Audi connect⁶

Audi connect

Comfortable connection of your vehicle to the internet for the use of Audi connect via an integrated data module with LTE⁷/UMTS support. There is a reader for your SIM card in the surround of the MMI navigation plus with MMI touch. The following services supported by Audi connect are available in your model:

Communication

- Wi-Fi hotspot
- Messages (only available for A3 Sedan/S3 Sedan)
- Facebook access
- Twitter access

Mobility & navigation

- Point-of-interest (PoI) search (for A3 Sedan/S3 Sedan with voice control)
- Traffic information online
- Navigation with Google Earth™⁸ and Google Street View™⁸
- Destination entry via myAudi or Google Maps™⁸
- Picturebook navigation
- Flight information
- Train information
- Fuel prices
- Parking information

Infotainment

- Audi music stream
- Weather
- News online (customised)
- City events
- Travel information

Use of the services supported by Audi connect is possible only with the optional MMI navigation plus with MMI touch equipment and Audi connect. You also require a SIM card with data option and with LTE option⁷ to use LTE. The services are available only with an existing or separate mobile phone contract and only within the range of the respective mobile phone network. Additional costs may be incurred when receiving data packets from the internet, depending on the terms of your mobile phone contract, particularly when used abroad. Because of the high data volumes involved, a data flat rate is strongly recommended. The availability of the services supported by Audi connect varies from country to country. The services are provided for at least one year from vehicle delivery. For the use of some services, one-off registration is required and some individual configuration on the myAudi platform under www.audi.com/myaudi. The traffic information online and messages services require initial activation in the vehicle. For services which require initial activation there is a 36-month usage limit from the time of activation (in as far as activation takes place within 6 months of vehicle delivery; otherwise corresponding shortening of the usage rights). Audi connect allows access to Facebook and Twitter services. Permanent availability cannot be guaranteed, Facebook and Twitter are responsible for this. Please visit www.audi.com/connect or contact your Audi partner for more detailed information about Audi connect; contact your mobile services provider for information about contract conditions.

¹ Reception depends on digital network availability. ² Please contact your Audi partner or visit www.audi.com/mp3 for information on compatible media players. ³ Navigation data are not available for all countries and regions. Please contact your local Audi partner for more information. ⁴ Map update service for the first five navigation updates at six-month intervals. The most up-to-date navigation data are made available for download on the myAudi platform at www.audi.com/myaudi and can be installed via SD card in the vehicle. In addition, it is possible to have the new navigation data installed at an Audi partner location at extra cost. ⁵ Provided that the mobile telephone has the Bluetooth profile MAP (Message Access Profile). Please contact your Audi partner or visit www.audi.com/bluetooth for information on compatible mobile phones. ⁶ Requires the optional Audi connect. ⁷ Please consult your Audi partner for information on the availability and use of LTE support. ⁸ Google and the Google logo are registered trademarks of Google Inc.

| Infotainment



Audi phone box*

allows phone calls with improved reception quality and charging by inserting mobile phone into the front centre console compartment. Hands-free facility and, for A3 Sedan/S3 Sedan, voice control (telephone). Low SAR radiation inside the vehicle thanks to connection to vehicle aerial. Operated via radio/navigation systems or multifunction leather steering wheel

Connectivity package

combines the following features:

- Audi music interface
- Bluetooth interface for connecting Bluetooth-capable mobile phones with Bluetooth audio streaming
- preparation for navigation system (navigation function and map data available as retrofit solution from Audi Genuine Accessories)
- additional SDXC card reader (up to 2 TB)

In conjunction with the Audi music interface, the AUX-IN connection is omitted.

Bluetooth interface

allows hands-free calls to be made in the vehicle using the microphone and – depending on the mobile phone compatibility* – Bluetooth audio streaming. Bluetooth-compatible mobile phones can be connected to the vehicle via the interface.

| Audi Extended Warranty

Audi Extended Warranty

offers protection against risk and can control servicing costs even after the first 2 years. It can only be ordered directly and on purchase of a new car and is a consistent continuation of the manufacturer's guarantee. 9 combinations of service life and mileage can be selected. For more information please consult your Audi partner.

Audi Genuine Accessories. As individual as you are.

An Audi is an expression of your personality. Audi Genuine Accessories quite literally build on that principle, offering high-quality products to match your Audi. Products that stand for precision tailoring, safety and functionality. To ensure your chosen model is even more individually tailored to you and your personal requirements. To make your Audi truly your own. These two pages give you a glimpse of the extensive range of Audi Genuine Accessories available for your Audi A3 Cabriolet.



Detailed information can be obtained from the Audi A3 accessories catalogue at www.audi.com and from your Audi partner.

**Cast aluminium wheels in 5-arm velum design,
matt black, gloss turned finish**

Elegant dynamics. In size 7.5 J x 18 (A3 and A3 Sportback) and 8 J x 18 (A3 Sedan and A3 Cabriolet) for 225/40 R 18 tyres.





Audi wireless internet access

for establishing an in-vehicle mobile Wi-Fi connection. Serves as a hotspot for up to 8 mobile devices such as tablets, laptops and smartphones. Extends up to 100 m outside the vehicle. Not limited by battery life thanks to a router integrated in the vehicle. With roaming function, including for prepaid cards.

Audi baby seat

secured using the 3-point belt. The integrated safety harness provides good restraint, whilst the attached hood offers protection from sunlight. With adjustable head restraint. Suitable for infants from birth age weighing up to 13 kg (approx. 12 months).

Adapter cables for Audi music interface*

Enables the connection of various iPod™ models and other portable media players. Operation via the MMI® system, if this function is supported by the media player.

Audi children's world

Fun and games guaranteed with the Audi soft toy steering wheel and cuddly animal. Matches the child seat design.



Rubber floor mats

A perfect fit. Provide better protection against coarse soiling. Connected with the vehicle through fixing points on the vehicle floor. With Audi A3 logo.



*For more detailed information, please contact your Audi partner.

The fuel consumption and CO₂ emission figures as well as the efficiency classes can be found from page 112 onwards.

Model	A3 Sedan 1.4 TFSI (92 kW)	A3 Sedan/A3 Cabriolet 1.4 TFSI (103 kW)		A3 Sedan/A3 Cabriolet 1.8 TFSI (132 kW)		A3 Sedan 1.8 TFSI quattro (132 kW)	A3 Sedan 1.6 TDI (77 kW)			
Engine type	4-cylinder inline petrol engine with direct fuel injection, turbocharging and intercooling	4-cylinder inline petrol engine with direct fuel injection, turbocharging, indirect intercooling, Audi cylinder on demand technology		4-cylinder inline petrol engine with direct fuel injection, turbocharging and intercooling		4-cylinder inline petrol engine with direct fuel injection, turbocharging and intercooling	4-cylinder inline diesel engine with common rail injection system, turbocharging and indirect intercooling			
Displacement in cc (valves per cylinder)	1,395 (4)	1,395 (4)		1,798 (4)		1,798 (4)	1,598 (4)			
Max. output ¹ in kW at rpm	92/5,000–6,000	103/5,000		132/5,100–6,200		132/4,500–6,200	77/3,000–4,000			
Max. torque in Nm at rpm	200/1,400–4,000	250/1,500–3,500		250/1,250–5,000		280/1,350–4,500	250/1,500–2,750			
Power transmission/wheels										
Drive type	Front-wheel drive	Front-wheel drive		Front-wheel drive		quattro® permanent all-wheel drive	Front-wheel drive			
Transmission type	6-speed manual transmission	6-speed manual transmission [7-speed S tronic]		6-speed manual transmission [7-speed S tronic]		[6-speed S tronic]	6-speed manual transmission [7-speed S tronic]			
Wheels ²	Steel wheels, 7 J x 16	Steel wheels, 7 J x 16		Steel wheels, 7 J x 16		Steel wheels, 7 J x 16	Steel wheels, 7 J x 16			
Tyres ²	205/55 R 16 ³	205/55 R 16 ³		205/55 R 16 ³		205/55 R 16 ³	205/55 R 16 ³			
Weights/capacities										
Unladen weight ⁴ in kg	1,290	1,315	[1,325]	1,440	1,345	[1,370]	[1,505]	[1,470]	1,350	[1,365]
Gross vehicle weight in kg	1,765	1,790	[1,800]	1,865	1,820	[1,845]	[1,930]	[1,945]	1,825	[1,840]
Permissible roof load limit/nose weight in kg	75/75	75/75	[75/75]	-/75	75/75	[75/75]	[-/75]	[75/75]	75/75	[75/75]
Trailer load limit ⁵ in kg unbraked	640	650	[660]	720	670	[680]	[750]	[730]	670	[680]
12 % gradient	1,400	1,500	[1,500]	1,500	1,600	[1,600]	[1,600]	[1,600]	1,500	[1,500]
8 % gradient	1,600	1,700	[1,700]	1,700	1,800	[1,800]	[1,800]	[1,800]	1,700	[1,700]
Fuel tank capacity, approx. in l	50	50	[50]	50	50	[50]	[50]	[55]	50	[50]
Performance/consumption⁶										
Top speed in km/h	212	219	[217]	218	242	[235]	[242]	[235]	198	[198]
Acceleration 0–100 km/h in s	9.4	8.4	[8.4]	9.1	7.2	[7.3]	[7.8]	[6.8]	10.9	[10.9]
Fuel grade	Sulphur-free super RON 95 ⁸	Sulphur-free super RON 95 ⁸			Sulphur-free super RON 95 ⁸			Sulphur-free super RON 95 ⁸	Sulphur-free diesel ⁹	
Fuel consumption ¹¹ in l/100 km urban	6.7	5.9	[5.9]	6.1	7.4	[7.0]	[7.3]	[8.2]	4.6	[4.8]
extra-urban	4.4	4.2	[4.1]	4.3	4.9	[4.8]	[4.8]	[5.6]	3.3	[3.4]
combined	5.3	4.8	[4.7]	5.0	5.8	[5.6]	[5.8]	[6.6]	3.8	[3.9]
CO ₂ emissions ¹¹ in g/km urban	155	135	[135]	140	172	[160]	[169]	[189]	121	[125]
extra-urban	102	97	[94]	99	113	[111]	[112]	[131]	86	[89]
combined	122	111	[109]	114	135	[129]	[133]	[152]	99	[102]
Efficiency class/emission standard	B/EU6	A/EU6	[A]/EU6	A/EU6	C/EU6	[B]/EU6	[B]/EU6	[C]/EU6	A+/EU5	[A]/EU5

[] Figures for S tronic. Explanation of ¹ to ¹¹ on page 114.

Model	A3 Sedan 2.0 TDI (110 kW)		A3 Sedan/A3 Cabriolet 2.0 TDI clean diesel (110 kW)		A3 Sedan 2.0 TDI quattro (110 kW)	S3 Sedan 2.0 TFSI quattro (221 kW)	
Engine type	4-cylinder inline diesel engine with common rail injection system, turbocharging and indirect intercooling		4-cylinder inline diesel engine with common rail injection system, turbocharging and indirect intercooling		4-cylinder inline diesel engine with common rail injection system, turbocharging and indirect intercooling	4-cylinder inline petrol engine with direct fuel injection, turbocharging and intercooling	
Displacement in cc (valves per cylinder)	1,968 (4)		1,968 (4)		1,968 (4)	1,984 (4)	
Max. output ¹ in kW at rpm	110/3,500-4,000		110/3,500-4,000		110/3,500-4,000	221/5,500-6,200	
Max. torque in Nm at rpm	320/1,750-3,000		340/1,750-3,000		320/1,750-3,000	380/1,800-5,500	
Power transmission/wheels							
Drive type	Front-wheel drive		Front-wheel drive		quattro® permanent all-wheel drive	quattro® permanent all-wheel drive	
Transmission type	6-speed manual transmission [7-speed S tronic]		6-speed manual transmission		6-speed manual transmission	6-speed manual transmission [6-speed S tronic]	
Wheels ²	Steel wheels, 7 J x 16		Steel wheels, 7 J x 16		Steel wheels, 7 J x 16	Cast aluminium wheels, 8 J x 18	
Tyres ²	205/55 R 16 ³		205/55 R 16 ³		205/55 R 16 ³	225/40 R 18 ³	
Weights/capacities							
Unladen weight ⁴ in kg	1,390 [1,415]		1,390	A3 Cabriolet 1,535	1,475	1,505 [1,525]	
Gross vehicle weight in kg	1,865 [1,890]		1,865	1,960	1,950	1,980 [2,000]	
Permissible roof load limit/nose weight in kg	75/75 [75/75]		75/75	-/75	75/75	75/- [75/-]	
Trailer load limit ⁵ in kg							
unbraked	690 [700]		690	750	730	- [-]	
12 % gradient	1,600 [1,600]		1,600	1,600	1,800	- [-]	
8 % gradient	1,800 [1,800]		1,800	1,800	1,800	- [-]	
Fuel tank capacity, approx. in l	50 [50]		50	50	55	55 [55]	
Performance/consumption⁶							
Top speed in km/h	220 [219]		224	224	220	250 ⁷ [250 ⁷]	
Acceleration 0-100 km/h in s	8.7 [8.4]		8.6	8.9	8.5	5.3 [4.9]	
Fuel grade	Sulphur-free diesel ⁹		Sulphur-free diesel ⁹		Sulphur-free diesel ⁹	Sulphur-free super plus RON 98 ¹⁰	
Fuel consumption ¹¹ in l/100 km							
urban	5.2 [5.5]		5.0	5.1	5.9	9.1 [8.8]	
extra-urban	3.5 [3.9]		3.6	3.7	4.0	5.8 [5.9]	
combined	4.1 [4.5]		4.1	4.2	4.7	7.0 [6.9]	
CO ₂ emissions ¹¹ in g/km							
urban	134 [144]		129	132	153	209 [202]	
extra-urban	91 [103]		94	97	103	135 [136]	
combined	107 [118]		107	110	121	162 [159]	
Efficiency class/emission standard	A/EU5 [A]/EU5		A/EU6	A+/EU6	A/EU5	D/EU6 [D]/EU6	

Explanatory notes

- ¹ The figure given was calculated using the specified measuring procedure (current version of Directive 80/1269/EEC).
- ² For Ambition: cast aluminium wheels, size 7.5 J x 17 with 225/45 R 17 tyres.
For Ambiente: cast aluminium wheels, size 7 J x 16 with 205/55 R 16 tyres.
- ³ You will find specifications on the technical characteristics of tyres in the adjacent table.
- ⁴ Unladen vehicle weight includes driver (68 kg), 7 kg of luggage and fuel tank 90 % full, calculated in accordance with the current version of EC Directive 92/21/EEC. Optional equipment may increase the car's unladen weight and drag coefficient, whereupon the possible payload limit and the top speed will be reduced accordingly.
- ⁵ The engine's power output always decreases with increasing altitude. At 1,000 m above sea level, and for every additional 1,000 m, deduct 10 % from the weight of the outfit (trailer load limit + gross weight of the towing vehicle). Figure for trailer load limit applies to factory-fitted trailer towing hitch. If using the vehicle with a trailer towing hitch for commercial purposes, a digital tachograph may be required under certain conditions.
- ⁶ A vehicle's fuel consumption and CO₂ emissions do not just depend on how efficiently the vehicle uses the fuel, but are also influenced by driving behaviour and other non-technical factors. CO₂ is the greenhouse gas primarily responsible for global warming.
- ⁷ Regulated.
- ⁸ We recommend using sulphur-free super unleaded RON 95 in accordance with DIN EN 228. If this is not available, use sulphur-free regular unleaded RON 91 in accordance with DIN EN 228; power output will be slightly reduced. Unleaded RON 95 fuel with a maximum ethanol content of 10 % (E10) can generally be used. Fuel consumption details refer to operation with RON 95 fuel in accordance with 692/2008/EC.
- ⁹ We recommend using sulphur-free diesel in accordance with DIN EN 590. If this is not available, use diesel in accordance with DIN EN 590.
- ¹⁰ We recommend using sulphur-free super plus unleaded RON 98 in accordance with DIN EN 228. If this is not available, use sulphur-free super unleaded RON 95 in accordance with DIN EN 228; power output will be slightly reduced. Unleaded RON 95 fuel with a maximum ethanol content of 10 % (E10) can generally be used. Fuel consumption details refer to operation with RON 95 fuel in accordance with 692/2008/EC.
- ¹¹ The figures given were calculated using the specified measuring procedures. The figures do not refer to one individual vehicle and do not form part of any offer, but rather should be used purely for purposes of comparison between the different vehicle models.

Important note

Inspections are due as shown by the service display.

Classifications of tyre parameters

The table shows the range of fuel efficiency, wet grip and exterior noise emission classes for the different tyre sizes of the A3 Sedan, A3 Cabriolet and S3 Sedan.

	Tyre size	Fuel efficiency class	Wet grip class	Exterior noise emission class	
Summer tyres	205/55 R 16	F–C	E–B	69–67	
	225/45 R 17	E	C–B	70–67	
	225/40 R 18	E	B	72–71	
	235/35 R 19	C	A	72	
Winter tyres	205/55 R 16	E	C–B	69–68	
	205/50 R 17	F–C	E–B	71–69	
	225/40 R 18	F	E	69	

It is not possible to order a specific tyre. For information on the range of tyres available in your country, please contact your Audi partner.

Audi A3 Sedan

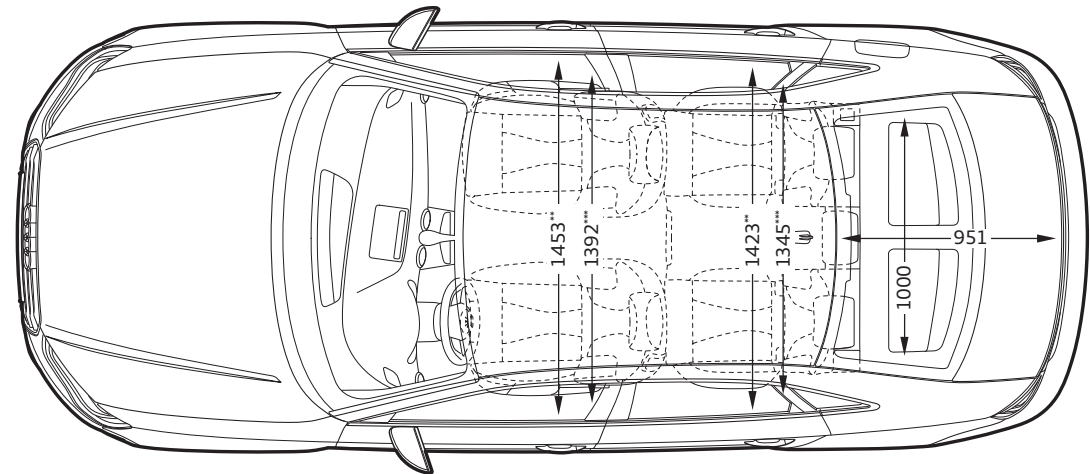
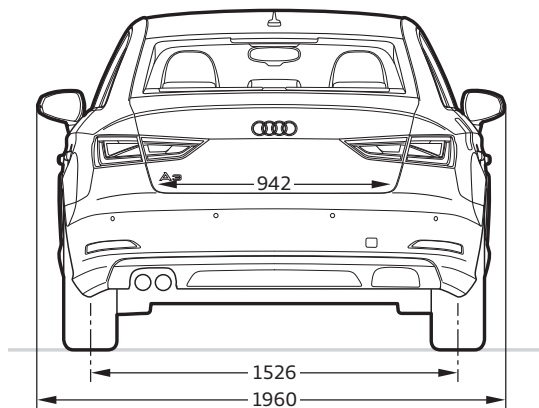
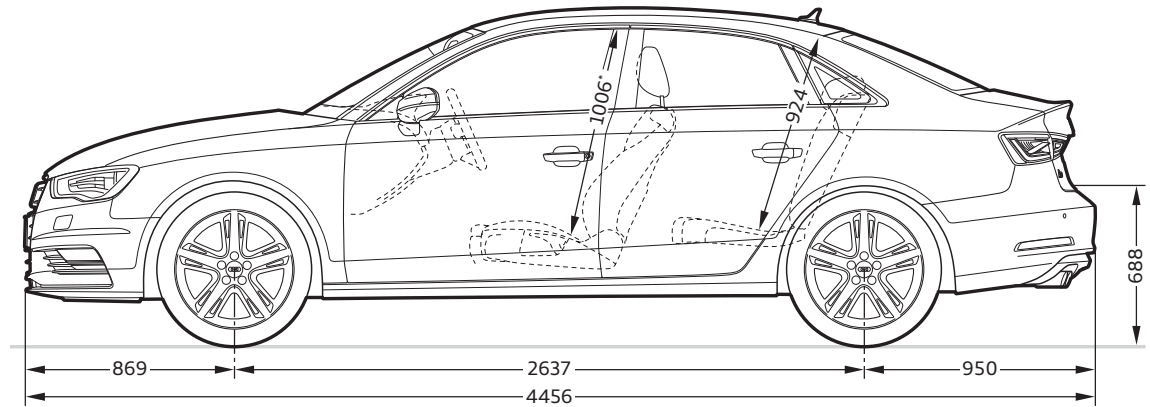
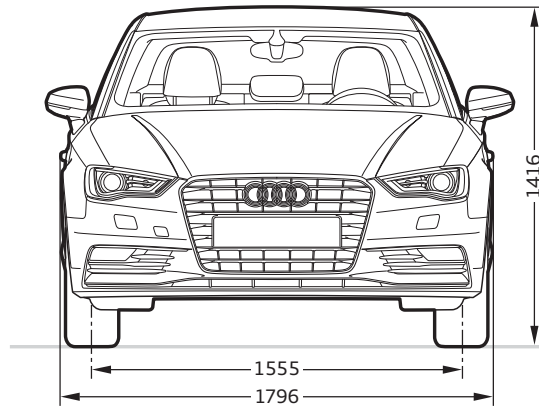
**Dimensions in millimetres.**

Dimensions were measured with vehicle at unladen weight.

Luggage compartment volume: front-wheel drive 425 l; quattro permanent all-wheel drive 390 l (measured by the VDA method using 200 x 100 x 50 mm blocks).

Turning circle approx. 11.0 m.

*Maximum headroom. **Elbow room width. ***Shoulder room width.

Audi A3 Cabriolet

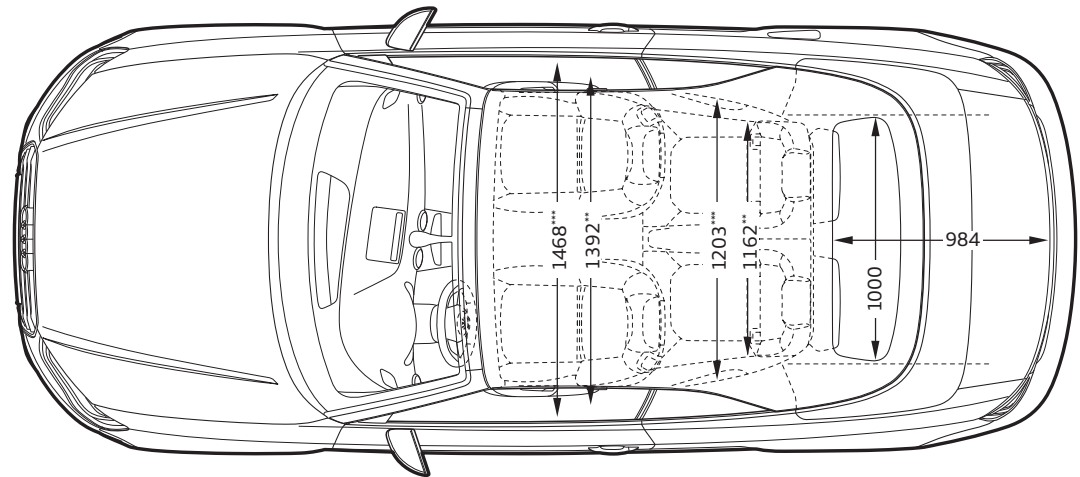
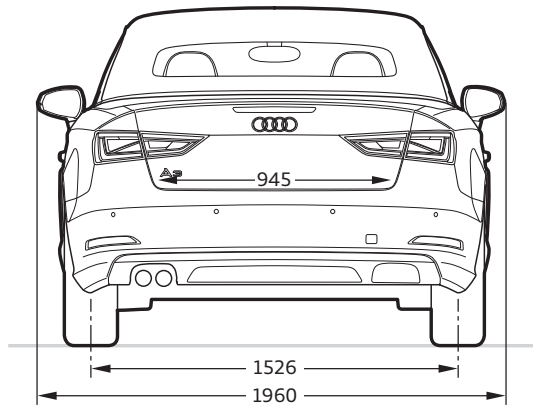
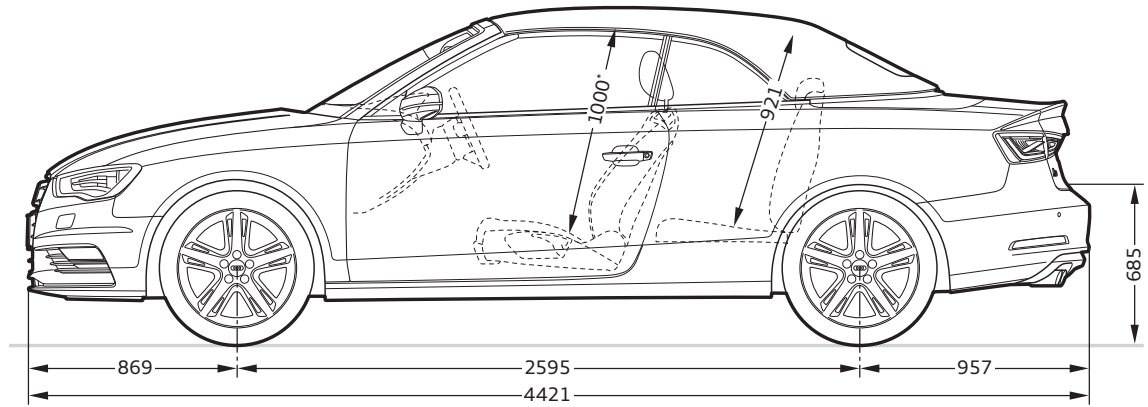
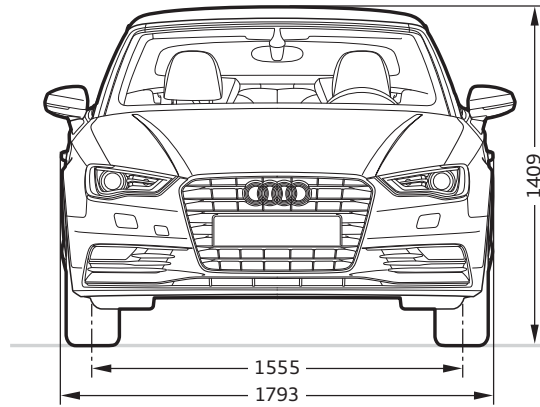
**Dimensions in millimetres.**

Dimensions were measured with vehicle at unladen weight.

Luggage compartment volume: 320 l

(measured by the VDA method using 200 x 100 x 50 mm blocks).

Turning circle approx. 10.9 m.

*Maximum headroom. **Elbow room width. ***Shoulder room width.

Audi S3 Sedan

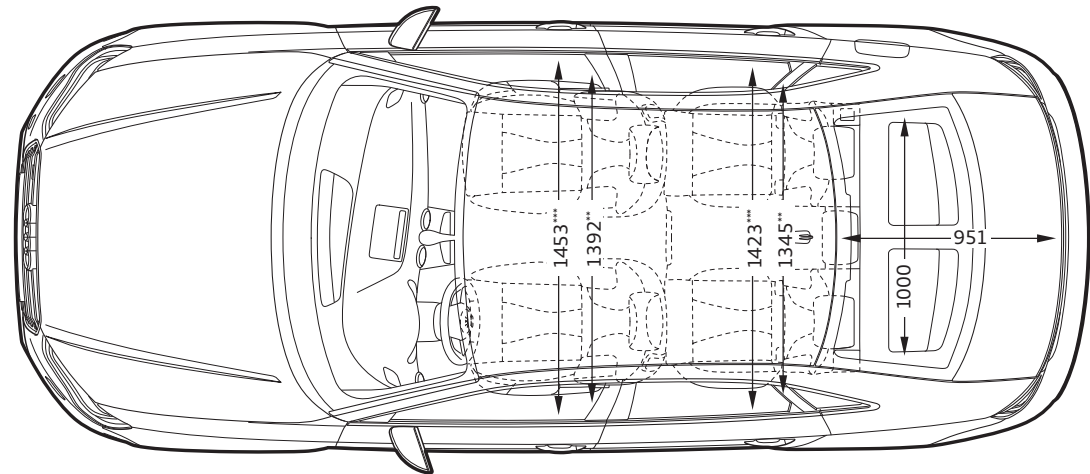
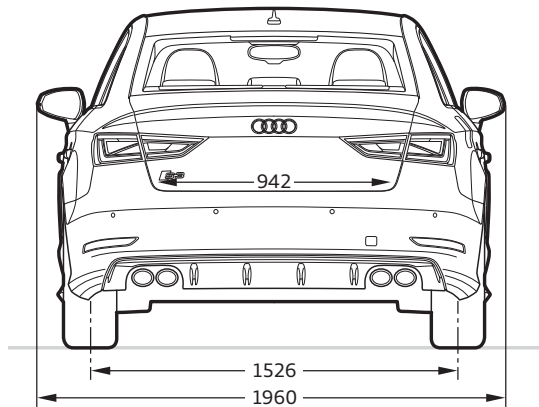
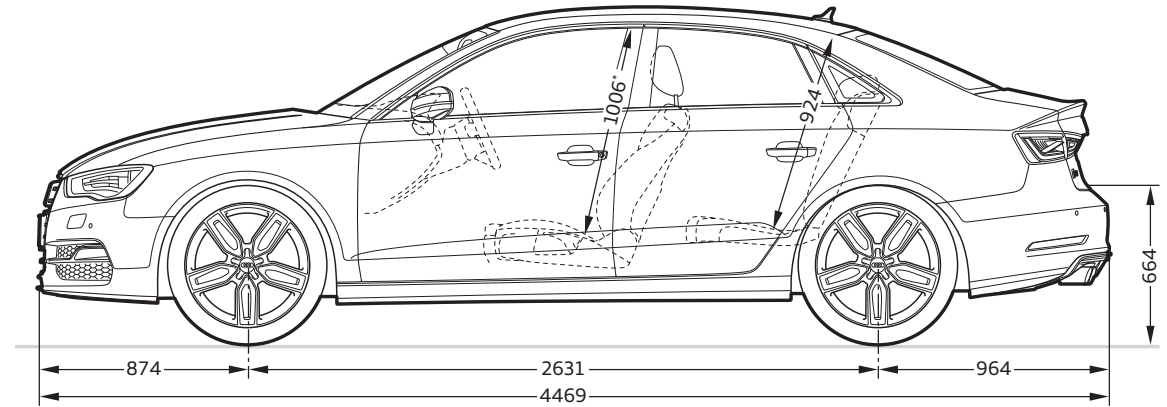
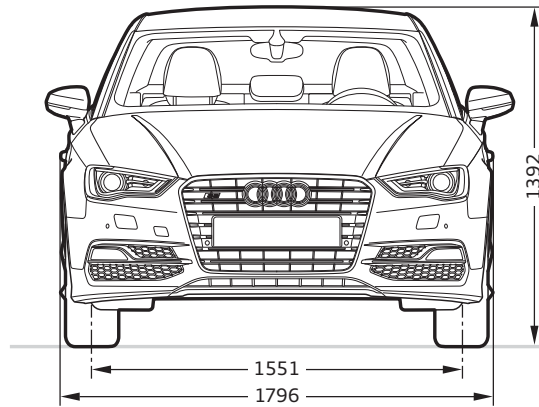
**Dimensions in millimetres.**

















Dimensions were measured with vehicle at unladen weight.

Luggage compartment volume: 390 l;

(measured by the VDA method using 200 x 100 x 50 mm blocks).









Turning circle approx. 11.0 m.









*Maximum headroom. **Elbow room width. ***Shoulder room width.







	Page	A3 Sedan/ A3 Cabriolet Attraction	A3 Sedan/ A3 Cabriolet Ambition	A3 Sedan/ A3 Cabriolet Ambiente	S3 Sedan
Equipment packages	80				
S line exterior package		■	■	■	—
S line sport package		—	■	—	—
Solid paint finishes	86				
 Amalfi white		□	□	□	□
 Brilliant red		□	□	□	□
 Brilliant black		□	□	□	□
Metallic paint finishes	86				
 Ice silver, metallic		■	■	■	■
 Monsoon grey, metallic		■	■	■	■
 Dakota grey, metallic		■	■	■	—
 Beluga brown, metallic		■	■	■	■
 Glacier white, metallic		■	■	■	■
 Shiraz red, metallic		■	■	■	—
 Scuba blue, metallic		■	■	■	—
 Lotus grey, metallic		■	■	■	—
Pearl effect paint finishes	87				
 Misano red, pearl effect		■	■	■	■
 Phantom black, pearl effect		■	■	■	■
 Daytona grey, pearl effect ¹		—	■	—	—
 Sepang blue, pearl effect ²		—	—	—	■
Crystal effect paint finish	87				
 Panther black, crystal effect		—	—	—	■

□ Standard equipment ■ Optional equipment ■ Standard/optional equipment varies by model — not available















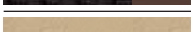

Country-specific variations possible. Please find out from your Audi partner which equipment is standard and what optional equipment is available in your country.

	Page	A3 Sedan/ A3 Cabriolet Attraction	A3 Sedan/ A3 Cabriolet Ambition	A3 Sedan/ A3 Cabriolet Ambiente	S3 Sedan
Customised paint finishes	87				
 Audi exclusive customised paint finishes ²		■	■	■	■
Wheels/tyres	88				
 16" steel wheels including full wheel covers		□	—	—	—
 16" cast aluminium wheels in 10-spoke design		■	—	—	—
 16" cast aluminium wheels in 15-spoke Y-design		—	—	□	—
 17" cast aluminium wheels in 5-arm design		—	□	—	—
 17" cast aluminium wheels in 5-spoke star design		■	■	■	—
 17" cast aluminium wheels in 10-spoke dynamic design		■	■	■	—
 18" cast aluminium wheels in multi-spoke star design, contrasting grey, partly polished		■	■	■	—

	Page	A3 Sedan/ A3 Cabriolet Attraction	A3 Sedan/ A3 Cabriolet Ambition	A3 Sedan/ A3 Cabriolet Ambiente	S3 Sedan
		—	■ ³	—	□
		—	—	—	■
		■	■	■	■
		■	■	■	■
		■	■	■	■
		■	■	■	■
		■	■	■	■
		■	■	■	■





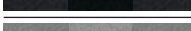
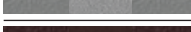





	Page	A3 Sedan/ A3 Cabriolet Attraction	A3 Sedan/ A3 Cabriolet Ambition	A3 Sedan/ A3 Cabriolet Ambiente	S3 Sedan
		■	■	■	—
		■	■	■	—
		■	■	■	■
		■	■	■	■
Anti-theft wheel bolts		■	■	■	■
Tyre repair kit		□ ⁵	□ ⁵	□ ⁵	□
Tyre pressure loss indicator		■	■	■	■
Vehicle tool kit		□	□	□	□
Vehicle jack ⁶		■	■	■	■
Spare wheel, space-saving		□ ⁷	□ ⁷	□ ⁷	■
Hood colours	86				
	Hood, black	□	□	□	—
	Hood, brown ⁸	■	■	■	—
	Hood, grey ⁸	■	■	■	—



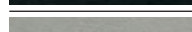



¹Only available in conjunction with S line sport package. ²For information on when this feature will be available, please contact your Audi partner. ³Standard in conjunction with S line sport package. ⁴Only available for engine models from 92 kW and only in conjunction with sport suspension or Audi magnetic ride (S3 Sedan: only in conjunction with Audi magnetic ride). ⁵Standard for A3 Sedan models with quattro permanent all-wheel drive and for A3 Cabriolet. ⁶Standard in conjunction with space-saving spare wheel or in conjunction with winter wheels. ⁷Standard for A3 Sedan models with front-wheel drive. ⁸Only available in conjunction with acoustic hood.

	Page	A3 Sedan/ A3 Cabriolet Attraction	A3 Sedan/ A3 Cabriolet Ambition	A3 Sedan/ A3 Cabriolet Ambiente	S3 Sedan
Seats	90				
Standard seats, front		☐	—	☐	—
Sport seats, front		■	☐	■	☐
S sport seats, front		—	■ ¹	—	■
Seat upholstery for standard seats, front	92				
 Marathon cloth, black		☐	—	—	—
 Marathon cloth, titanium grey		☐	—	—	—
 Regatta cloth/mono.pur, black		—	—	☐	—
 Regatta cloth/mono.pur, titanium grey		—	—	☐	—
 Regatta cloth/mono.pur, pashmina beige		—	—	☐	—
 Regatta cloth/mono.pur, chestnut brown		—	—	☐	—
 Milano leather, pashmina beige		■	—	■	—
 Milano leather, black		■	—	■	—
 Audi exclusive leather upholstery and trim ²		■	—	■	—
Seat upholstery for sport seats, front	92				
 Rallye cloth, black/black		—	☐	—	—
 Rallye cloth, black/silver		—	☐	—	—
 Rallye cloth, black/blue		—	☐	—	—
 Rallye cloth, black/yellow		—	☐	—	—
 Biathlon cloth/leather, black		—	■ ³	—	—
 Trophy cloth/leather, black		—	—	—	☐
 Milano leather, black		■	■	■	—
 Milano leather, titanium grey		■	■	■	—
 Milano leather, chestnut brown		■	■	■	—

☐ Standard equipment ■ Optional equipment ■ Standard/optional equipment varies by model — not available

Country-specific variations possible. Please find out from your Audi partner which equipment is standard and what optional equipment is available in your country.

	Page	A3 Sedan/ A3 Cabriolet Attraction	A3 Sedan/ A3 Cabriolet Ambition	A3 Sedan/ A3 Cabriolet Ambiente	S3 Sedan
 Alcantara/leather, black		■	■	■	■
 Alcantara/leather, titanium grey		■	■	■	—
 Alcantara/leather, lunar silver		—	—	—	■
 Perforated Alcantara/leather, black		—	■ ¹	—	—
 Fine Nappa leather, black		—	■ ¹	—	■
 Fine Nappa leather, lunar silver		—	—	—	■
 Audi design selection lasso brown		—	■	—	—
 Audi design selection parade red		—	—	—	■
 Audi exclusive leather upholstery and trim ²		■	■	■	■
Seat upholstery for S sport seats, front	93				
 Fine Nappa leather, black		—	■ ¹	—	■
 Audi exclusive leather upholstery and trim ²		—	■	—	■
Cloth/leather upholstery and trim	95				
Marathon cloth		☐	—	—	—
Regatta cloth/mono.pur		—	—	☐	—
Rallye cloth		—	☐	—	—
Trophy cloth/leather		—	—	—	☐
Alcantara/leather combination		■	■	■	■
Milano leather		■	■	■	—
Fine Nappa leather		—	■ ¹	—	■
Audi design selection lasso brown		—	■	—	—
Audi design selection parade red		—	—	—	■
Audi exclusive Alcantara/fine Nappa leather upholstery and trim (package 1) ²		■	■	■	■
Audi exclusive fine Nappa leather upholstery and trim (package 1) ²		■	■	■	■

	Page	A3 Sedan/ A3 Cabriolet Attraction	A3 Sedan/ A3 Cabriolet Ambition	A3 Sedan/ A3 Cabriolet Ambiente	S3 Sedan
Audi exclusive extended leather upholstery and trim ²		■	■	■	■
Extended interior elements mono.pur		■	■	■	■
Headlinings/hood linings					
Headlining in lunar silver/pashmina beige cloth (colour-coordinated with interior)		□	□	□	■ ⁴
Headlining in black cloth		■	■	■	□
Hood lining in black cloth		□	□	□	–
Hood lining in lunar silver cloth ²		■	■	■	–
Inlays	97				
 Micrometallic, silver		□	□	–	–
 3D-design "Optic"		■	■	□	–
 Aluminium mistral, silver		■	■	■	–
 Aluminium mistral, bronze		■	■	■	–
 Matt brushed aluminium		–	■ ³	–	□
 3D-design "Black"		–	■ ¹	–	■
Technology	98				
Audi drive select		■	□	■	□
Audi magnetic ride		■	■	■	■
Start-stop system		□	□	□	□
Recuperation		□	□	□	□
Audi cylinder on demand ⁵		□	□	□	–
Diesel particulate filter, additive-free		□	□	□	–
Audi TDI clean diesel (nitrogen oxide storage catalytic converter) ⁶		■	■	■	–
Manual transmission ⁷		□	□	□	□
S tronic ^{®7}		□	□	□	□

	Page	A3 Sedan/ A3 Cabriolet Attraction	A3 Sedan/ A3 Cabriolet Ambition	A3 Sedan/ A3 Cabriolet Ambiente	S3 Sedan
Front-wheel drive		□	□	□	–
quattro [®]		□ ⁷	□ ⁷	□ ⁷	□
Dynamic suspension		□	■	□	–
Sport suspension		■	□	■	–
S line sport suspension		■	■	■	–
S sport suspension (p. 73)		–	–	–	□
Electromechanical power steering		□	□	□	□
Progressive steering		■ ⁸	■ ⁸	■ ⁸	□
Brake system with disc brakes front and rear		□	□	□	□
Secondary collision brake assist		□	□	□	□
Electromechanical parking brake		□	□	□	□
Lights	99				
Headlights		□	□	□	–
Headlight cleaning system ⁹		■	■	■	□
Light/rain sensor		■	■	■	■
High-beam assist		■	■	■	■
Xenon plus including headlight cleaning system		■	■	■	□
Front fog lights ¹⁰		■	□	■	–
Variable headlight range control ¹¹		■	■	■	■
LED headlights		■	■	■	■
adaptive light		■	■	■	■
Rear lights		□	□	□	–
Adaptive brake light		□	□	□	□
LED rear lights ⁹		■	■	■	□

¹Only available in conjunction with S line sport package. ²For information on when this feature will be available, please contact your Audi partner. ³Standard in conjunction with S line sport package ⁴Only available in lunar silver cloth.

⁵Only for 1.4 TFSI (103 kW). ⁶Only for 2.0 TDI clean diesel (110 kW). ⁷Please refer to the technical data to check the availability for the engine model of your choice. ⁸Not available for 1.4 TFSI (92 kW) and 1.6 TDI (77 kW).

⁹Part of xenon plus including headlight cleaning system or LED headlights. ¹⁰Not available in conjunction with LED headlights. ¹¹Only available in conjunction with adaptive light and Audi active lane assist.

	Page	A3 Sedan/ A3 Cabriolet Attraction	A3 Sedan/ A3 Cabriolet Ambition	A3 Sedan/ A3 Cabriolet Ambiente	S3 Sedan
Lights (continued)	99				
Lighting package		■	■	□	■
Interior lighting		□	□	□	□
Design	100				
Exhaust tailpipes		□	□	□	□
Model/technology name		□	□	□	□
Brake callipers, painted red (p. 73)		–	–	–	■
Gloss package		■ ¹	■ ¹	□ ¹	■
Door sill trims (p. 73, p. 78-81)		–	□	□	□
Aluminium-look exterior ²		□	□	□	–
Aluminium look in the interior		■	■	■	□
Operation	100				
Steering wheel in 4-spoke design		□	–	–	–
Leather steering wheel in 4-spoke design		■	–	□	–
Sport leather steering wheel in 3-spoke design		–	□	–	□
Multifunction leather steering wheel in 4-spoke design		■	–	■	–
Multifunction sport leather steering wheel in 3-spoke design		–	■	–	–
Multifunction sport leather steering wheel in 3-spoke design, flattened at the bottom		–	■	–	■
Audi exclusive leather steering wheel rim ³		■	■	■	■
Audi exclusive leather controls ³		■	■	■	■
Audi exclusive aluminium gear lever knob ³		■	■	■	■ ⁴
Remote control key		□	□	□	□
Convenience key		■	■	■	■
Luggage compartment lid, automatically opening		□ ¹	□ ¹	□ ¹	□

□ Standard equipment ■ Optional equipment – not available

Country-specific variations possible. Please find out from your Audi partner which equipment is standard and what optional equipment is available in your country.

	Page	A3 Sedan/ A3 Cabriolet Attraction	A3 Sedan/ A3 Cabriolet Ambition	A3 Sedan/ A3 Cabriolet Ambiente	S3 Sedan
Comfort	101				
Panoramic glass sunroof		■ ¹	■ ¹	■ ¹	■
Wind deflector ²		■	■	□	–
Acoustic windscreen		□	□	□	□
Windscreen cleaning system		□	□	□	□
Heat-insulating glass		□	□	□	□
Dark-tinted windows (privacy glazing)		■ ¹	■ ¹	■ ¹	■
Heated rear window		□	□	□	□
Hood		□	□	□	–
Acoustic hood		■	■	■	–
Convenience entry ²		□	□	□	–
Front-passenger seat, height-adjustable		□	□	□	□
Driver seat, electrically adjustable ⁵		■ ¹	■ ¹	■ ¹	■
Front seats, electrically adjustable ⁵		■ ¹	■ ¹	■ ¹	■
4-way lumbar support for the front seats		■	■	■	■
Ventilation system and heating		□	□	□	□
Manual air conditioning		□	□	□	–
Deluxe automatic air conditioning		■	■	■	□
Auxiliary heating/ventilation		■	■	■	–
Seat heating, front		■	■	■	■
Headroom heating ²		■	■	■	–
Heat protection ⁶		□	□	□	–
Illuminated vanity mirrors, for driver and front passenger		■	■	□	□
Sun visors, swivelling and folding, for driver and front passenger		□	□	□	□

	Page	A3 Sedan/ A3 Cabriolet Attraction	A3 Sedan/ A3 Cabriolet Ambition	A3 Sedan/ A3 Cabriolet Ambiente	S3 Sedan
Grab handles ¹		<input type="checkbox"/>	<input type="checkbox"/>	<input type="checkbox"/>	<input type="checkbox"/>
Centre armrest, front		<input checked="" type="checkbox"/>	<input checked="" type="checkbox"/>	<input type="checkbox"/>	<input type="checkbox"/>
Centre console with storage compartment		<input type="checkbox"/>	<input type="checkbox"/>	<input type="checkbox"/>	<input type="checkbox"/>
Mobile phone/key holder		<input checked="" type="checkbox"/>	<input checked="" type="checkbox"/>	<input checked="" type="checkbox"/>	<input checked="" type="checkbox"/>
Cigarette lighter and ashtray		<input checked="" type="checkbox"/>	<input checked="" type="checkbox"/>	<input checked="" type="checkbox"/>	<input checked="" type="checkbox"/>
12V socket in the front centre console		<input type="checkbox"/>	<input type="checkbox"/>	<input type="checkbox"/>	<input type="checkbox"/>
Floor mats, front		<input type="checkbox"/>	<input type="checkbox"/>	<input type="checkbox"/>	<input type="checkbox"/>
Floor mats, rear		<input checked="" type="checkbox"/>	<input checked="" type="checkbox"/>	<input checked="" type="checkbox"/>	<input checked="" type="checkbox"/>
Transport	103				
Storage and luggage compartment package		<input checked="" type="checkbox"/>	<input checked="" type="checkbox"/>	<input checked="" type="checkbox"/>	<input type="checkbox"/>
Storage compartments		<input type="checkbox"/>	<input type="checkbox"/>	<input type="checkbox"/>	<input type="checkbox"/>
Rear seat backrest, folding		<input type="checkbox"/>	<input type="checkbox"/>	<input type="checkbox"/>	<input type="checkbox"/>
Through-loading facility		<input checked="" type="checkbox"/> ¹	<input checked="" type="checkbox"/> ¹	<input checked="" type="checkbox"/> ¹	<input checked="" type="checkbox"/>
Ski/snowboard bag		<input checked="" type="checkbox"/>	<input checked="" type="checkbox"/>	<input checked="" type="checkbox"/>	<input checked="" type="checkbox"/>
Lashing points in the luggage compartment		<input type="checkbox"/>	<input type="checkbox"/>	<input type="checkbox"/>	<input type="checkbox"/>
Reversible mat		<input checked="" type="checkbox"/> ¹	<input checked="" type="checkbox"/> ¹	<input checked="" type="checkbox"/> ¹	<input checked="" type="checkbox"/>
Hood compartment, variable ²		<input type="checkbox"/>	<input type="checkbox"/>	<input type="checkbox"/>	–
Provision for trailer towing hitch ⁷		<input checked="" type="checkbox"/>	<input checked="" type="checkbox"/>	<input checked="" type="checkbox"/>	–
Trailer towing hitch		<input checked="" type="checkbox"/>	<input checked="" type="checkbox"/>	<input checked="" type="checkbox"/>	–
Safety	103				
Exterior mirrors with integrated LED indicators		<input type="checkbox"/>	<input type="checkbox"/>	<input type="checkbox"/>	<input type="checkbox"/>
Exterior mirrors, heated		<input checked="" type="checkbox"/>	<input checked="" type="checkbox"/>	<input checked="" type="checkbox"/>	<input checked="" type="checkbox"/>

	Page	A3 Sedan/ A3 Cabriolet Attraction	A3 Sedan/ A3 Cabriolet Ambition	A3 Sedan/ A3 Cabriolet Ambiente	S3 Sedan
Exterior mirrors, heated and electrically folding		<input checked="" type="checkbox"/>	<input checked="" type="checkbox"/>	<input checked="" type="checkbox"/>	<input checked="" type="checkbox"/>
Exterior mirrors, heated, electrically folding and automatically dimming on the driver side		<input checked="" type="checkbox"/>	<input checked="" type="checkbox"/>	<input checked="" type="checkbox"/>	<input checked="" type="checkbox"/>
Interior mirror, dimming		<input type="checkbox"/>	<input type="checkbox"/>	<input type="checkbox"/>	<input type="checkbox"/>
Interior mirror, automatically dimming		<input checked="" type="checkbox"/>	<input checked="" type="checkbox"/>	<input checked="" type="checkbox"/>	<input checked="" type="checkbox"/>
Electronic immobiliser		<input type="checkbox"/>	<input type="checkbox"/>	<input type="checkbox"/>	<input type="checkbox"/>
Anti-theft alarm		<input checked="" type="checkbox"/>	<input checked="" type="checkbox"/>	<input checked="" type="checkbox"/>	<input type="checkbox"/>
Preparation for tracking system		<input checked="" type="checkbox"/>	<input checked="" type="checkbox"/>	<input checked="" type="checkbox"/>	<input checked="" type="checkbox"/>
Airbags		<input type="checkbox"/>	<input type="checkbox"/>	<input type="checkbox"/>	<input type="checkbox"/>
Side airbags, front		<input type="checkbox"/>	<input type="checkbox"/>	<input type="checkbox"/>	<input type="checkbox"/>
Head airbag system		<input type="checkbox"/> ¹	<input type="checkbox"/> ¹	<input type="checkbox"/> ¹	<input type="checkbox"/>
Side airbags, rear		<input checked="" type="checkbox"/> ¹	<input checked="" type="checkbox"/> ¹	<input checked="" type="checkbox"/> ¹	<input checked="" type="checkbox"/>
Side impact protection		<input type="checkbox"/>	<input type="checkbox"/>	<input type="checkbox"/>	<input type="checkbox"/>
Safety steering column		<input type="checkbox"/>	<input type="checkbox"/>	<input type="checkbox"/>	<input type="checkbox"/>
Integrated head restraint system		<input type="checkbox"/>	<input type="checkbox"/>	<input type="checkbox"/>	<input type="checkbox"/>
Active roll-over protection ²		<input type="checkbox"/>	<input type="checkbox"/>	<input type="checkbox"/>	–
Seat belts		<input type="checkbox"/>	<input type="checkbox"/>	<input type="checkbox"/>	<input type="checkbox"/>
Seat belt reminder		<input type="checkbox"/>	<input type="checkbox"/>	<input type="checkbox"/>	<input type="checkbox"/>
ISOFIX child seat mounting for the front-passenger seat		<input checked="" type="checkbox"/>	<input checked="" type="checkbox"/>	<input checked="" type="checkbox"/>	<input checked="" type="checkbox"/>
ISOFIX child seat mounting and Top Tether for the outer rear seats		<input type="checkbox"/>	<input type="checkbox"/>	<input type="checkbox"/>	<input type="checkbox"/>
Warning and control lights		<input type="checkbox"/>	<input type="checkbox"/>	<input type="checkbox"/>	<input type="checkbox"/>
Warning triangle		<input type="checkbox"/>	<input type="checkbox"/>	<input type="checkbox"/>	<input type="checkbox"/>
First-aid kit		<input type="checkbox"/>	<input type="checkbox"/>	<input type="checkbox"/>	<input type="checkbox"/>

¹Only available for A3 Sedan/S3 Sedan. ²Only available for A3 Cabriolet. ³For information on when this feature will be available, please contact your Audi partner. ⁴Without S3 logo on the gear lever knob.

⁵Only in conjunction with 4-way lumbar support for the front seats. ⁶Only available for A3 Cabriolet in conjunction with leather upholstery and trim or Alcantara/leather combination. ⁷Trailer towing hitch available for retrofitting from Audi Genuine Accessories.

	Page	A3 Sedan/ A3 Cabriolet Attraction	A3 Sedan/ A3 Cabriolet Ambition	A3 Sedan/ A3 Cabriolet Ambiente	S3 Sedan
Assistance systems	104				
Anti-Slip Regulation (ASR)		<input type="checkbox"/>	<input type="checkbox"/>	<input type="checkbox"/>	<input type="checkbox"/>
Electronic Differential Lock (EDL)		<input type="checkbox"/>	<input type="checkbox"/>	<input type="checkbox"/>	<input type="checkbox"/>
Electronic Stabilisation Control (ESC)		<input type="checkbox"/>	<input type="checkbox"/>	<input type="checkbox"/>	<input type="checkbox"/>
Electronic Stabilisation Control (ESC) with electronic axle-differential lock ¹		<input type="checkbox"/>	<input type="checkbox"/>	<input type="checkbox"/>	—
Hold assist		<input checked="" type="checkbox"/>	<input checked="" type="checkbox"/>	<input checked="" type="checkbox"/>	<input checked="" type="checkbox"/>
Park assist with selective display		<input checked="" type="checkbox"/>	<input checked="" type="checkbox"/>	<input checked="" type="checkbox"/>	<input checked="" type="checkbox"/>
Reversing camera		<input checked="" type="checkbox"/>	<input checked="" type="checkbox"/>	<input checked="" type="checkbox"/>	<input checked="" type="checkbox"/>
Parking system, rear		<input checked="" type="checkbox"/>	<input checked="" type="checkbox"/>	<input type="checkbox"/>	<input checked="" type="checkbox"/>
Parking system plus with selective display		<input checked="" type="checkbox"/>	<input checked="" type="checkbox"/>	<input checked="" type="checkbox"/>	<input checked="" type="checkbox"/>
Cruise control		<input checked="" type="checkbox"/>	<input checked="" type="checkbox"/>	<input type="checkbox"/>	<input checked="" type="checkbox"/>
Audi pre sense basic		<input checked="" type="checkbox"/>	<input checked="" type="checkbox"/>	<input checked="" type="checkbox"/>	<input checked="" type="checkbox"/>
Audi active lane assist		<input checked="" type="checkbox"/>	<input checked="" type="checkbox"/>	<input checked="" type="checkbox"/>	<input checked="" type="checkbox"/>
Audi pre sense front		<input checked="" type="checkbox"/>	<input checked="" type="checkbox"/>	<input checked="" type="checkbox"/>	—
Audi side assist		<input checked="" type="checkbox"/>	<input checked="" type="checkbox"/>	<input checked="" type="checkbox"/>	<input checked="" type="checkbox"/>
adaptive cruise control including Audi pre sense front		<input checked="" type="checkbox"/>	<input checked="" type="checkbox"/>	<input checked="" type="checkbox"/>	<input checked="" type="checkbox"/>
Camera-based recognition of traffic signs ²		<input checked="" type="checkbox"/>	<input checked="" type="checkbox"/>	<input checked="" type="checkbox"/>	<input checked="" type="checkbox"/>
Assistance package		<input checked="" type="checkbox"/>	<input checked="" type="checkbox"/>	<input checked="" type="checkbox"/>	<input checked="" type="checkbox"/>

Standard equipment Optional equipment — not available

Country-specific variations possible. Please find out from your Audi partner which equipment is standard and what optional equipment is available in your country.

	Page	A3 Sedan/ A3 Cabriolet Attraction	A3 Sedan/ A3 Cabriolet Ambition	A3 Sedan/ A3 Cabriolet Ambiente	S3 Sedan
Infotainment	105				
Driver information system		<input checked="" type="checkbox"/>	—	—	—
Driver information system with colour display		<input checked="" type="checkbox"/>	<input type="checkbox"/>	<input type="checkbox"/>	<input type="checkbox"/>
Audi radio		<input type="checkbox"/>	<input type="checkbox"/>	<input type="checkbox"/>	<input type="checkbox"/>
MMI® radio		<input checked="" type="checkbox"/>	<input checked="" type="checkbox"/>	<input checked="" type="checkbox"/>	<input checked="" type="checkbox"/>
Digital Audio Broadcasting		<input checked="" type="checkbox"/>	<input checked="" type="checkbox"/>	<input checked="" type="checkbox"/>	<input checked="" type="checkbox"/>
Audi sound system		<input checked="" type="checkbox"/>	<input checked="" type="checkbox"/>	<input checked="" type="checkbox"/>	<input checked="" type="checkbox"/>
Bang & Olufsen Sound System		<input checked="" type="checkbox"/>	<input checked="" type="checkbox"/>	<input checked="" type="checkbox"/>	<input checked="" type="checkbox"/>
Audi music interface		<input checked="" type="checkbox"/>	<input checked="" type="checkbox"/>	<input checked="" type="checkbox"/>	<input checked="" type="checkbox"/>
Adapter cable set for Audi music interface		<input checked="" type="checkbox"/>	<input checked="" type="checkbox"/>	<input checked="" type="checkbox"/>	<input checked="" type="checkbox"/>
Adapter cable set plus for Audi music interface		<input checked="" type="checkbox"/>	<input checked="" type="checkbox"/>	<input checked="" type="checkbox"/>	<input checked="" type="checkbox"/>
Navigation package		<input checked="" type="checkbox"/>	<input checked="" type="checkbox"/>	<input checked="" type="checkbox"/>	<input checked="" type="checkbox"/>
MMI® navigation plus with MMI touch		<input checked="" type="checkbox"/>	<input checked="" type="checkbox"/>	<input checked="" type="checkbox"/>	<input checked="" type="checkbox"/>
Audi connect		<input checked="" type="checkbox"/>	<input checked="" type="checkbox"/>	<input checked="" type="checkbox"/>	<input checked="" type="checkbox"/>
Audi phone box		<input checked="" type="checkbox"/>	<input checked="" type="checkbox"/>	<input checked="" type="checkbox"/>	<input checked="" type="checkbox"/>
Connectivity package		<input checked="" type="checkbox"/>	<input checked="" type="checkbox"/>	<input checked="" type="checkbox"/>	<input checked="" type="checkbox"/>
Bluetooth interface		<input checked="" type="checkbox"/>	<input checked="" type="checkbox"/>	<input checked="" type="checkbox"/>	<input checked="" type="checkbox"/>
Audi Extended Warranty	108				
Audi Extended Warranty		<input checked="" type="checkbox"/>	<input checked="" type="checkbox"/>	<input checked="" type="checkbox"/>	<input checked="" type="checkbox"/>

Equipment for the Audi A3 Sedan illustrated (p. 4–19):

Paint finish: glacier white, metallic

Wheels: Audi exclusive cast aluminium wheels in 5-arm-wing design in glossy titanium look, gloss turned finish

Seat upholstery: Milano leather, titanium grey

Inlays: aluminium mistral, silver

Equipment for the Audi A3 Cabriolet illustrated (p. 20–35):

Paint finish: glacier white, metallic

Wheels: Audi exclusive cast aluminium wheels in 5-V-spoke design in matt titanium look, gloss turned finish

Seat upholstery: Milano leather, chestnut brown

Inlays: aluminium mistral, silver

Equipment for the Audi S3 Sedan illustrated (p. 36–47):

Paint finish: Misano red, pearl effect

Wheels: cast aluminium wheels in 5-twin-spoke star design (S design), contrasting grey, partly polished

Seat upholstery: fine Nappa leather, black (shoulder area in fine Nappa leather embroidered with contrasting stitching)

Inlays: matt brushed aluminium

¹ Only for models with front-wheel drive. ² Only with Audi active lane assist in conjunction with MMI navigation plus with MMI touch.



Discover



The Audi experience

The fascination of Audi can be experienced in many different ways. Audi City in London, for example, gives you digital access to all models at their actual size and in real time. And of course it is always worth visiting one of the major motor shows. This is where Audi always presents its new models and invites you to take a look at how the future is being shaped with "Vorsprung durch Technik". Anyone interested in seeing how Audi is already putting this into practice will find fascinating insight in the "Vorsprung durch Technik" online special at www.audi.com. But a look back can also be rewarding:

at the Audi mobile museum in Ingolstadt, history and high-tech go hand in hand. A total of 130 historic exhibits and state-of-the-art forms of presentation make for a thrilling symbiosis. Plus, Audi driving experience allows you to live the excitement and countless possibilities of current Audi models. Here, pure driving enjoyment is combined with valuable learning effects. This is ensured by a team of specially trained and highly qualified instructors who provide practical tips to help you optimise your driving skills.