



A5

Audi A5 Coupe | A5 Cabriolet

Audi
Truth in Engineering



If it was this easy, it wouldn't be an Audi.

Obsession



IMAGINE DEVOTING YOUR LIFE TO BUILDING YOUR MODEL.

When you were a kid, you probably felt quite proud when you completed a model kit. We understand. At Audi, it takes countless hours for a single Audi to go from idea to design to roadworthy, and that's time we are very proud to devote. Our obsession for detail,

commitment to premium fit and finish and passion for unparalleled engineering go into every model. It's the kind of discipline that the word "painstaking" was invented to describe. Not to say it's a chore—no, assembling an Audi is a labor of love, and it shows every time you sit in one, engage the ignition and nudge the accelerator. Creating an Audi isn't easy, but the results help define what Audi means to the people who drive one.

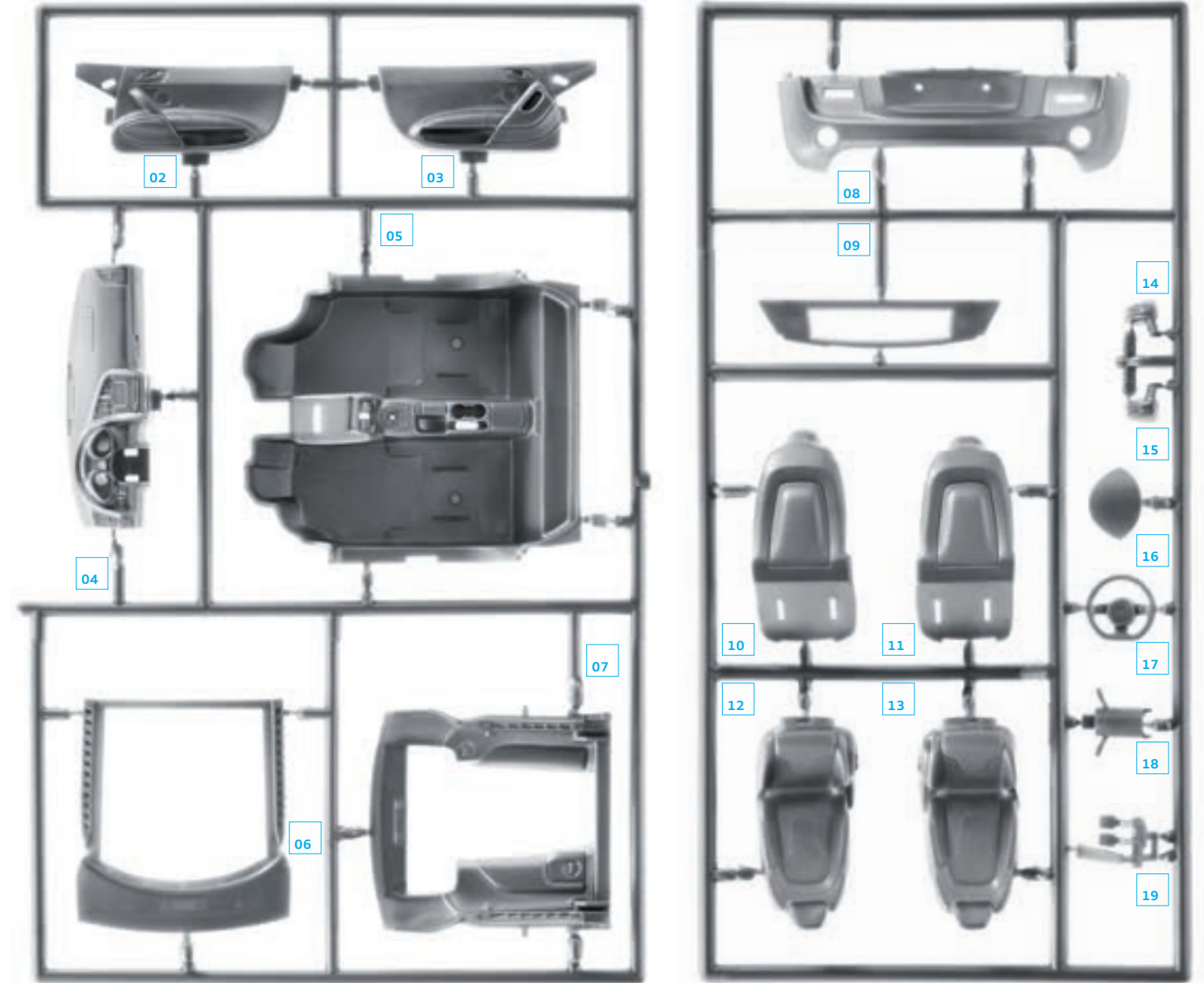



The door of perception.

OUR REPUTATION HINGES ON THE QUALITY OF THINGS YOU DON'T SEE.

It's said that, when one door closes, another one opens. It sounds as if whoever said it spent some time at an Audi research and development facility. After all, while you'll open and close the door on your Audi thousands of times without thinking about it, we've obsessed about it for you, in detail. Not just about the reliability of it opening and

closing, but on the proper weight that will make it more pleasing to close. How the locks should click when they are engaged. The optimal acoustic placement for the speaker port. There are the hinges too, of course. And the door itself, which we designed to take the brunt of side-impact collisions, and several dozen other safety considerations (to say nothing of the countless other components, processors, sensors, window features and the inner workings most people will never see). Our doors are more than a symbol of welcoming you into your vehicle, they are products of Audi engineering, and the very perception of Audi hinges on them as much as our hinges help support the door.

ACOUSTIC ENHANCEMENTS

We use soft mounts on our window regulator and a sound-absorbing backing within the door cavity itself to make the cabin even quieter.

INNOVATIVE DESIGN

By using fully pressed aluminum doors in the Audi A6, the door structures were reduced by an astonishing 44 lb compared to the previous model.

SPEAKER PLACEMENT

Optimal speaker placement helps deliver the most extraordinary sound you can find in the automotive space.

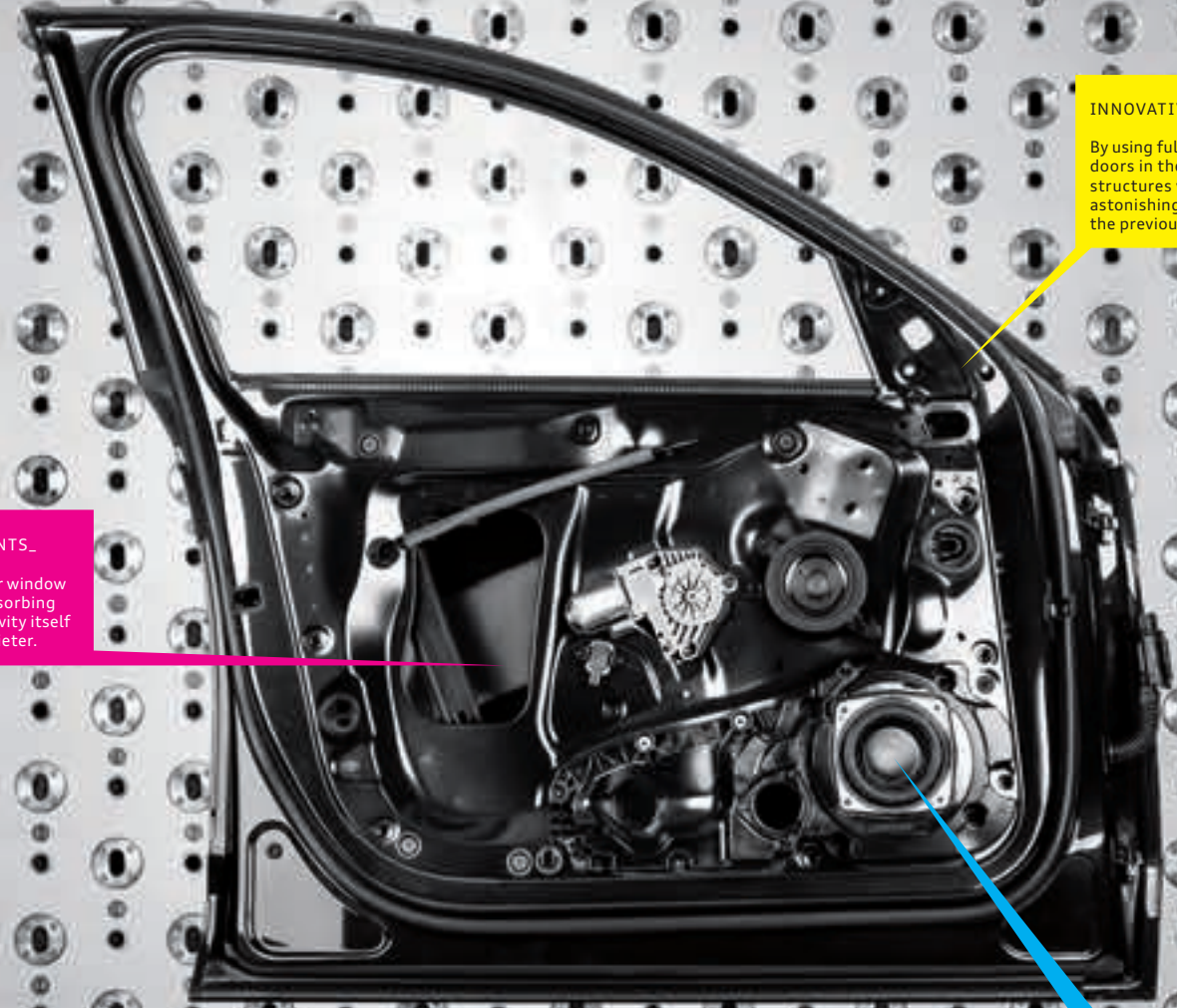

When we think of a good idea, it sticks.



SURFACES

WET
DRY
SLIPPERY
UNEVEN

Torque is distributed to all four wheels in varying amounts.

Torque vectoring

By independently braking the inside cornering wheels, torque is then transferred to the outside cornering wheels. This intelligent application of power, known as torque vectoring, is available on select quattro® models and helps promote neutral handling by calculating the driver's steering input and desired level of acceleration.

Sport differential

To help ensure high cornering agility, the available sport differential uses torque vectoring, and then adds to that by mechanically applying additional torque to the outside rear cornering wheel. Through an electrohydraulic multiplate clutch pack and gear-set, the outside rear cornering wheel speed is increased by as much as 10%.

CORNERS

CURVES
MOUNTAINS
OBSTACLES
HANDLING
UNEXPECTED

Impressive stability, more assured road-holding, enhanced agility and improved steering precision.

TRACTION

ACCELERATION
TOWING
SNOW
CRUISING
GRAVEL

quattro® directs the amount of torque required to suit the job at hand.

quattro® HAS MAINTAINED ITS GRIP ON OUR THINKING AND THE ROADS WE TRAVEL.

For more than 30 years, Audi has been focused on quattro® all-wheel drive. During that time, it has evolved into an overarching idea of performance, a technological system of ratios, power delivery and driving dynamics working seamlessly together, orchestrated through the drivetrain, providing power where and when it is needed most. In

many ways, this has been a three-decade drive, from the Alps to the autobahn—and points beyond. You've seen quattro® capabilities in the way we dominated the World Rally Championship for years, in the grip you have in inclement weather, and in the variable power distribution you enjoy in good conditions.¹ For more than 30 years, and with over five million quattro® systems on the road, we have continued to refine the technology, developing an available rear sport differential to help maximize performance and available torque vectoring to assist with cornering traction while helping to improve handling. We've boldly stuck to what worked while the world was trying to catch up, and we built on it.

¹ When driving during cold, rainy, snowy or icy weather conditions, ensure that your vehicle is equipped with appropriate all-season or winter tires. Even with appropriate tires, you must always drive in a manner appropriate for the weather, visibility and road conditions.

The obsessive engineering of maximum fitness.



ENGINEERING POWER IS MORE THAN JUST ADDING MUSCLE.

There is an art to fitness. Yes, there are some who go for the massive, sculptured muscle look. But there is something more compelling out there for those with more refined tastes. The kind of sculpted efficiency found in Audi engines elevates the driving experience through smaller, finely tuned forced-

induction engines. For the drive to feel lean and precise, we've shaved off unwanted pounds. Sure, large numbers might distract some, but a champion impresses with its grace, power and athletic balance—captured in the right suspension setting, or a torque-vectoring corner. Audi engineers taste power that celebrates a true dedication to craft. It means strength that pulses at the moment of acceleration, provides a true, quick response as you change lanes, and turns the most routine cloverleaf into a joyful application of performance handling¹. This is the art of maximum fitness, to the point where others just feel a little flabby.

FSI[®]

The FSI direct injection fuel system directly injects fuel into the combustion chambers at precisely managed times and depths. What that means for drivers is that a fully homogenized intake charge helps increase power while also reducing fuel consumption and emissions, making efficiency more powerful.

TFSI[®]

At Audi, TFSI represents a combination of two of the brand's core areas of expertise—direct injection and forced induction. By adding turbocharging or supercharging to FSI direct injection, the pressurized intake charge is cooled by directly injected fuel, thus achieving efficiency and performance combined with higher compression ratios—previously only attainable by naturally aspirated engines².

TDI[®]

A turbocharged, fuel-sipping variant, our TDI[®] clean diesel engines deliver uncompromising Audi performance with bold efficiency¹. Yes, it gets better mileage per gallon than comparable gasoline engines²; but it also produces more low-end torque, which is best expressed in the elasticity you have when passing in the 30- to 60-mph range.

¹ Always obey all speed and traffic laws.
² See www.fueleconomy.gov for EPA estimates and emissions data. Your mileage and emissions will vary and depend on several factors, including your driving habits and vehicle condition.

ELEPHANT SKULL_

How nature solved the apparent conundrum of an elephant's skull didn't escape the notice of Heinrich Timm, the longtime lead engineer for Audi. The weight of the tusks and the general size of an elephant's head would seem to make it impossible for the animal to actually be able to carry it. But the design genius behind the elephant's skull is to make it lightweight yet sturdy. Its predominantly hollow design is buffered by thin, connective bone walls, which act as strong, weight-bearing cells. Audi designers used that idea when building our aluminum and steel structures. Reducing weight, yet enabling strength.



ultra



13
26.982

AU

ALUMINUM_

Our large aluminum castings are a telling example of ultra lightweight technology. Primarily used in high-stress areas, these castings achieve exceptional rigidity while also allowing for freedom of design, all while remaining extremely lightweight!

How studying elephant skulls makes for superior handling.

THE ELEGANT STRUCTURE OF NATURE BECOMES A BLUEPRINT OF EFFICIENCY.

It seems strange to say that, while we build strong, complex and high-performing machines, we're naturalists at heart. Then again, it might not be that unusual, seeing how nature itself builds strong, complex and high-performing machines as well. When we developed the thinking behind our ultra® lightweight technology initiative,

we knew that nature would serve as an inspiration to greater structural efficiency. Take the structure of the elephant skull pictured here. It has to be lightweight, yet capable of carrying a heavy load. It's porous, but its structure is such that it enhances its stability and strength. We do the same, for example, with aluminum. Positioned one way, aluminum materials can be flexible. Positioned another, they are strong and rigid, and help give better support. We also looked to bamboo, which is strong at the conjoined areas (nodes), and flexible along its stem. Our designs allow for both rigidity and flexibility where each is most needed, and for efficiency overall. As we continue to develop strategies to improve the performance aspects and efficiency of our vehicles, we don't shy away from the world around us? We boldly engage it even closer still.

1. Features and technologies listed are not available on all models. 2. See www.fueleconomy.gov for EPA estimates and emissions data. Your mileage and emissions will vary and depend on several factors, including your driving habits and vehicle condition.



Just talk to us, baby.



AUDI CONNECT® REALLY GETS WHAT YOU ARE SAYING.

Share what's on your mind. Looking for a great Chinese food place? We'll help you get there. Thinking about a rest stop? We'll locate the nearest gas station for you, and even give you the price of their fuel. In fact, in your Audi, just say the word, and we'll help you find almost anything, even your home phone number. With available Audi connect with Google

Voice™ command capabilities, we've developed a way to let you articulate your desires, even if that's just finding the closest burger stand or the best hotel.¹ MMI® navigation plus with Audi connect helps integrate networking capabilities on the go, along with Google Earth™ with 3D satellite imagery, to help you avoid traffic (and possibly saying things you might regret)² Audi connect also provides fast data transfer speeds and Wi-Fi® connectivity for up to eight passenger devices to help you stay informed. It offers a full suite of services and interactivity, and, yes, even the closest Szechuan restaurant, which you can find by using its Google™ Local Search capabilities. Best of all, you don't even have to say "Thank you," even if we appreciate it when you do.

1. Always pay careful attention to the road, and do not drive while distracted. The features and technologies discussed above are optional, may require an additional subscription with separate terms and conditions, and should be used only when it is safe and appropriate. The Wi-Fi® hotspot feature is intended for passenger use only. Features and technologies listed are not available on all models. The voice control feature is not available on Cabriolet or Roadster models. 2. MMI® navigation plus depends on signals from the worldwide Global Positioning Satellite network. The vehicle's electrical system and existing wireless and satellite technologies must be available and operating properly for the system to function. The system is designed to provide you with suggested routes in locating addresses, destinations and other points of interest. Changes in street names, construction zones, traffic flow, points of interest and other road system changes are beyond the control of Audi of America, Inc. Complete detailed mapping of lanes, roads, streets, toll roads, highways, etc., is not possible, therefore you may encounter discrepancies between the mapping and your actual location. Please rely on your individual judgment in determining whether or not to follow a suggested MMI® navigation plus route. For mapping updates please see your Audi dealer or call 1-800-FOR-AUDI for details. Features and technologies listed are not available on all models.



Hey, bright eyes.



DESIGNING A WINDOW TO OUR SOUL.

Even in the dark, you know when you're staring at an Audi. In fact, it might just be love at first sight. That's because, instead of cursing the darkness, we celebrate the light. Available full LED headlights stand out from the rest: their color inten-

sity is engineered to be reminiscent of daylight. But while we illuminate the night, we don't forget the day—so we made our LED daytime running lights to look even more dramatic. Now featuring a sleek diode design that gives us the freedom to elegantly reshape our signature style, Audi LED lighting is once again ours. It is an efficient, beautiful way to help you see and be seen from dusk to dawn and back again. Look deep into our eyes, and you might just see the soul of a company.



How we know
exactly what you feel.

CLEAN, BEAUTIFUL DESIGN COMES FROM DEDICATED CRAFTSMEN UNAFRAID OF GETTING THEIR HANDS DIRTY.

Our hands give you shade and sanctuary. Our hands give you comfort and control. You might not sense our hands nearby, but our hands know exactly what you feel. That's because we've been there. After all, our hands crafted a customized world that's dedicated to control, comfort and entertainment. We're talking,

of course, about the cabin of your Audi vehicle. Optimized luxury, designed by committed craftsmen who had you in mind when they chose the leather seating surfaces, created the contoured seats or provided the refinement of ergonomic design and an available more intuitive MMI® system. There are small touches that help simplify the overall design, and there are large statements to help you feel at ease. It is your Audi interior, shaped by the kind of people who know you want to experience luxury firsthand.



As you can see, our design will help channel water away from the mirror, allowing you a clearer view of what's behind you.



The molding on the inner A-pillar helps direct water away from the area where the windshield and A-pillar meet. Once the water is there, aerodynamic forces take over and funnel the water up and out of the windshield area rather than back and across the side windows.

You have to weather adversity to know things like this.

WHAT YOU DON'T KNOW MIGHT HELP YOU.

Think of it this way—if it rains, would you notice a dry side view mirror? Maybe not, but compared to one with beads of rain on it and distorted reflections, you would. It's a little thing, perhaps, but these little things are part of our deep obsession with crafting a premium driving experience.

We design our exterior side mirrors with small sills to channel water along their upper edge, helping leave your view unobstructed. We also design our windshield moldings with channels that allow rain water to efficiently run off instead of returning to the windshield wiper path. These are small touches, thought of by engineers and crafted by designers who don't necessarily call attention to their skills. Instead, these details reflect a commitment to quality that you might never notice—until a moment of bad weather or adversity, when you might. But don't worry. We don't mind if you don't notice us, now and then.



Either think about the future, or make history.



Preproduction vehicle shown.

e-tron[®]



SUPREMELY PRACTICAL LUXURY WITH A SUNNY KIND OF ENERGY.

Talking about a better future is easy. After all, how can you be held accountable for something that never arrives? But if you really want to affect it, to make history, you have to do more than talk. Enter e-tron[®]. It's not the first plug-in electric hybrid to the market, but we are making it the most forward-thinking Audi ever produced. For

example, we will be including a level 2 charger with our A3 Sportback e-tron PHEV for qualified owners who want to drive on electricity as much as possible.¹ We also plan to offer unique sustainable energy offerings like an available solar program to help provide power to your home and vehicle. It's not just practical, it's premium too, in style, in performance and in fit and finish, like any other Audi vehicle. But more than that, it will be Audi making smart technology smarter, with adaptive kinetic-energy-harnessing when you brake, and better performing than what came before it. With the Audi e-tron vehicles, we're saying the future is now.

¹ 240-volt wall-mounted charging hardware and cabinet included with the vehicle. Installation and wiring costs are extra, and will vary. See your participating dealer for details.



The little things that add up

01 Audi connect
Our Google™ powered information system.¹

02 Audi Care
Available convenient service option.

03 MMI updates
MMI navigation and other software updates.¹

04 SiriusXM® Satellite Radio
Endlessly diverse music channels with a complimentary trial offer.¹

05 Audi exclusive
Available customizable exterior and interior color and material options.

SENSE OF HUMOR

RESOURCEFUL

ROMANTIC

SENSE OF STYLE

GENEROUS

LOVING

to a long- term love.

MOVING FROM LUST TO APPRECIATION TAKES A DEEPER UNDERSTANDING.

When you are attracted to something, the effects are immediate, the domination, total. For a relationship to last, though, it must move beyond that passionate initial phase. It's what comes next that turns a bright flame into an eternal torch. That's why Audi doesn't simply design premium vehicles for the

short-term, but offers an entire experience that we hope lasts a lifetime. Do you want to customize your Audi? We offer Audi exclusive materials and colors. Do you want care-free service options? Audi Care is available. MMI® updates, trial offers for Audi connect®, a full suite of available Audi driver assistance technologies—these might not be the reasons why you fell in love with an Audi, but they are, perhaps, the things that help keep the heart fires stoked.¹

1 Optional features and technologies listed are not available on all models. See Infotainment/Technology section of the Featured Content page for important information regarding MMI® navigation plus and required SiriusXM® subscriptions.

IF THE TRUTH
THEN THE TRUE
A5 CARRIES

Inspirations that build an icon.

The alchemy needed to build an automotive icon is elusive. Sure, it's found, partly, on an assembly line, with committed artisans taking pride in every stitch they oversee. It's also on a drafting board, sketched by visionaries looking to further expand what we look for in automotive design lines. But it's also in the countless inspirations, ones little and large, that not only capture a bold thought or striking idea, but execute them. Examples of these can be found in the foundational stories we tell about our company and our vehicles. These stories show how an abstract idea can turn into a powerful, sculpted machine, and then how that machine can help forge an iconic reputation for a brand. Out of the inspirations we find in engineering, art and the large world of ideas, we have created a fearless, iconic company of substance and luxury: Audi.

ENGINEERING
LESS THAN AN

IS IN STYLE,
STYLE OF THE
ITSELF WITH
TOTAL HONESTY.
SPORT-DRIVEN
THAT IS NEVER
HONEST ICON.



Design

We do not follow design trends. We set them.

**We don't take chances,
we make strides.**

Nothing captures the imagination like an automobile that turns heads. That's why every double-take the Audi A5 gets is a testament to the adventurous spirit and bold sensibilities of both Audi designers and drivers alike. And that's why there is such a strong response to the sophisticated lines that sweep across the A5, as well as to the seductive punch of its acceleration. Everything we build into the A5, even the way we hide the B-pillar, is meant to give it a sense of movement. Something you might notice even when it is standing still. Heads turn because we pay attention to every detail, from the precision handling to the striking headlights with LED daytime running lights, which seem to stare back at the attention of onlookers. Available in Coupe and Cabriolet, there is an A5 crafted to provoke emotion, and maybe even a little envy, in every person who looks as you drive by.



Enlighten

A new light on illumination just happened to be a design boon.

Thrill and be thrilled.

It may be, as has been suggested, that the Audi A5 is a polarizing vehicle. Then again, magnets are like that. Of course, we know what draws people in. The unmistakable look, to start, but the power too. LED daytime running lights introduce inviting illumination, and the tapered Singleframe® grille adds a bold sense of daring and an iconic look to the front fascia. But one gathers the possibility of more, such as the power distributed by the impressive 2.0-liter turbocharged TFSI® engine and optimized by the quattro® all-wheel drive system. The details tell the story—sharpened design lines streamline the body, continually pushing the envelope of style while embracing the spirit of our Audi Sport® heritage. In short, the more we tried to thrill onlookers, the greater thrill we experienced ourselves.





We spared no expense in bringing you delight.

The finest materials pepper the interior of every Audi A5. There may be more cost-effective ways to design a vehicle's interior, but ours are intended to stimulate more than just your sight. You'll see, feel and smell the distinctive elements inside the A5. Whether it's the finely stitched leather-wrapped multifunction steering wheel in your hands, or the scent of our finely crafted leathers that greets you when you climb into the cockpit, you'll find exactly what you've come to expect from Audi: sleek, fluid and substantively composed interiors that solidify the connection between you and your vehicle.

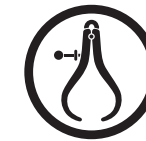

Craftsmanship

We've ensured that every stitch represents the detail that we put into every aspect of an Audi.



Panoramic sunroof

Another enhancement to your drive is the standard panoramic sunroof with tilt functionality of the A5 Coupe. An unimpeded view of the sky gives the feeling of infinite head room. If you don't want to fully engage with the environment, the retractable shade feature is there too. So let the sun drench the interior of your A5 as you enjoy a carefree driving experience.



Split folding rear seatbacks

With 12.2 cu ft of cargo space in the A5 Coupe and 10.2 cu ft of cargo space in the A5 Cabriolet with the rear seatbacks in the up position, the A5 is a capable carrier. The Cabriolet has split folding 50/50 rear seatbacks, and the Coupe features a pass-through in the split folding 60/40 rear seatbacks. You can enjoy all the benefits of a sports car and still have room for your oversized toys.



**A bold display of
interior performance.**

Thanks to our three-spoke multifunction steering wheel with available shift paddles, every control you need is right at your fingertips, intuitively placed to help establish an ease of operation while you navigate any commute. Our driver-centric cockpit is more than just a design imperative, it is our way to help ensure that you're navigating the vehicle's technology with the same precision that our vehicles perform with on the road!

1 Always pay careful attention to the road, and do not drive while distracted. The features and technologies discussed above are optional, may require an additional subscription with separate terms and conditions, and should be used only when it is safe and appropriate. The Wi-Fi® hotspot feature is intended for passenger use only.



Retractable acoustic folding soft top

The top of the A5 Cabriolet invites you to take advantage of clear skies for as long as the sun is out. If clouds do come, it takes approximately 17 seconds for the top to fully deploy (even at speeds up to 31 mph). When the top is up, it also provides a great acoustic environment designed with both sound-deadening and insulation properties.



Equal parts sun, sky and dreams.

It's style that includes stars, but has nothing to do with Hollywood. It's outside, but not obsessed with waterproof hiking boots. It's the world seen and felt with the top down in your Audi A5 Cabriolet. Day or night, with wind gliding past you, discover a thrilling connection to your environment—while still being plugged into signature automobile technology. You can even stretch your top-down driving season with an available head-level heating system that helps ensure your comfort even when the temperature doesn't match your mood. The A5 Cabriolet takes design, precision and a retractable roof to turn the outside into something that's very much in.



You may not think of SPF as an automotive spec.

We've got you covered, even with the top down. The available perforated Milano leather ventilated and heated comfort front seats create a tranquil commute no matter what the weather brings. From heat-reducing pigments in the leather to an aerodynamic windblocker that helps the air flow by when you open up the drive, we've thought of everything to help ensure your comfort. Just in case you've forgotten your sunscreen, you can easily bring the roof back up, further proof that you hold a wide range of power.



Ventilated and heated front seats

Some added comforts for the top-down drive along the coast are the available heated and ventilated comfort front seats. You can get a little extra touch of warmth from the available head-level heating system vents that blow warm air directly onto your neck and shoulders.

Thermocool feature

The leather surfaces of our Cabriolet front seats are designed with special Thermocool heat-reducing pigments that, even in direct sunlight, help reduce surface temperatures, compared to untreated leathers. It's just another way we prove our commitment to your comfort.

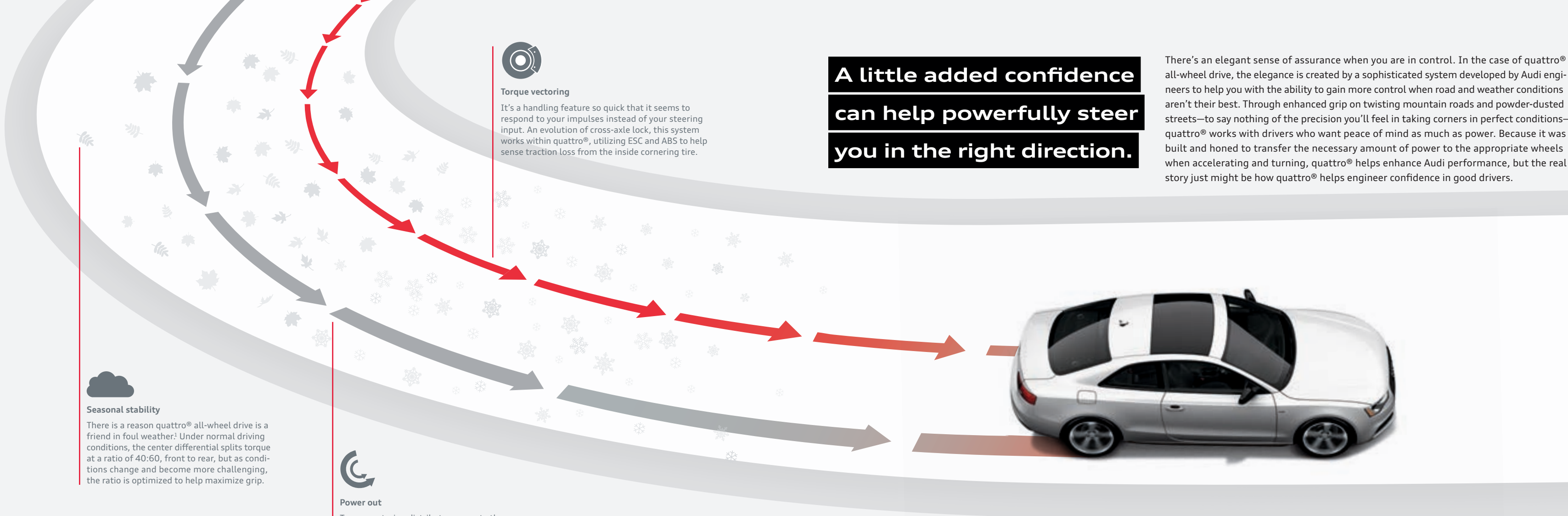

**A little added confidence
can help powerfully steer
you in the right direction.**

There's an elegant sense of assurance when you are in control. In the case of quattro® all-wheel drive, the elegance is created by a sophisticated system developed by Audi engineers to help you with the ability to gain more control when road and weather conditions aren't their best. Through enhanced grip on twisting mountain roads and powder-dusted streets—to say nothing of the precision you'll feel in taking corners in perfect conditions—quattro® works with drivers who want peace of mind as much as power. Because it was built and honed to transfer the necessary amount of power to the appropriate wheels when accelerating and turning, quattro® helps enhance Audi performance, but the real story just might be how quattro® helps engineer confidence in good drivers.



Torque vectoring
It's a handling feature so quick that it seems to respond to your impulses instead of your steering input. An evolution of cross-axle lock, this system works within quattro®, utilizing ESC and ABS to help sense traction loss from the inside cornering tire.



Seasonal stability
There is a reason quattro® all-wheel drive is a friend in foul weather.¹ Under normal driving conditions, the center differential splits torque at a ratio of 40:60, front to rear, but as conditions change and become more challenging, the ratio is optimized to help maximize grip.



Power out
Torque vectoring distributes power to the outside wheels when turning, helping give you added control in the corners.

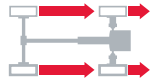

85:15
When accelerating, power is shifted to the rear wheels for extra rear traction.



Under normal driving conditions, power slightly favors the rear axle.

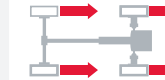

quattro® seamlessly transfers power as needed as driving conditions change.

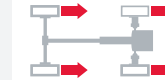

30:70
When traction is limited at either axle, power is shifted to the axle with the most traction.

¹ When driving during cold, rainy, snowy or icy weather conditions, ensure that your vehicle is equipped with appropriate all-season or winter tires. Even with appropriate tires, you must always drive in a manner appropriate for the weather, visibility and road conditions.

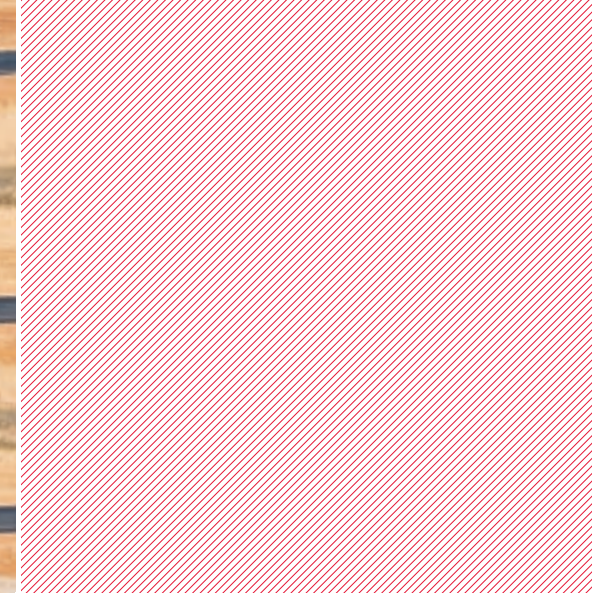
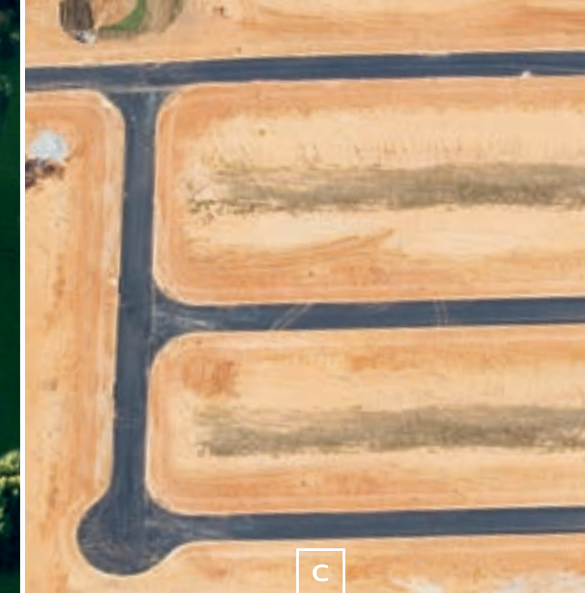
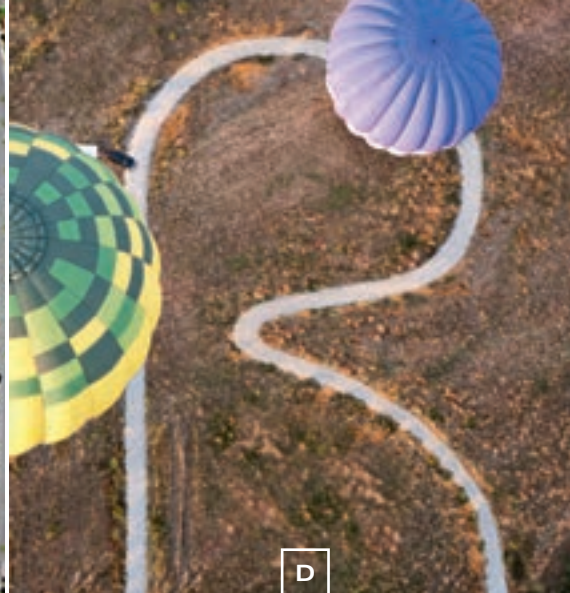

C **Comfort mode**
Perfect for those long highway stretches, this setting adds optimized steering and a closer shift pattern to help provide a more relaxed drive.

D **Dynamic mode**
Tighter steering and a more responsive throttle give this setting an aggressive feel and focused performance.

A **Auto mode**
The best of both worlds, dialed to automatically adjust settings for a seamless combination of comfort and responsiveness based on your driving style and road conditions.

I **Individual mode**
Take the turn your way—this mode allows you to adjust the steering, throttle and transmission upshifts to your style.

At Audi, we believe you should be the ultimate master of your road-going domain. That's why we created the available Audi drive select system. It gives you the ability to adjust the vehicle's steering, throttle response and transmission shift characteristics with the utmost of ease. And with four modes to choose from, when almost any kind of road comes into question, Audi drive select will let you answer.

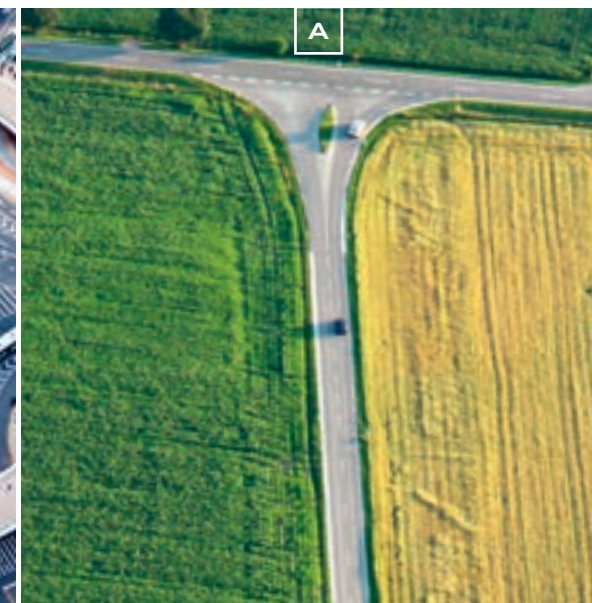
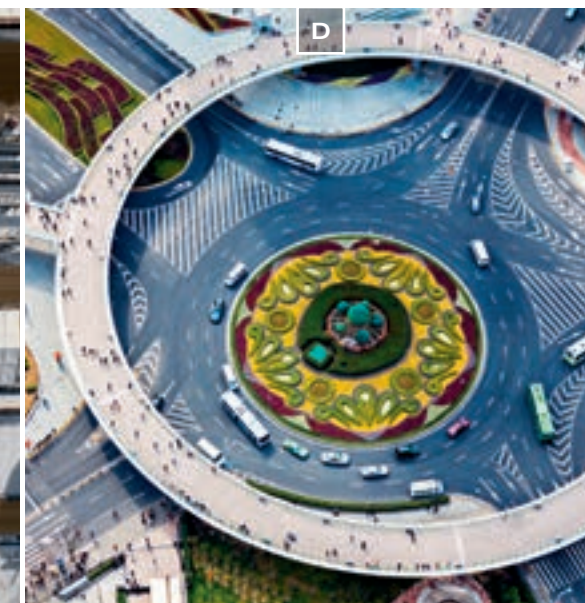
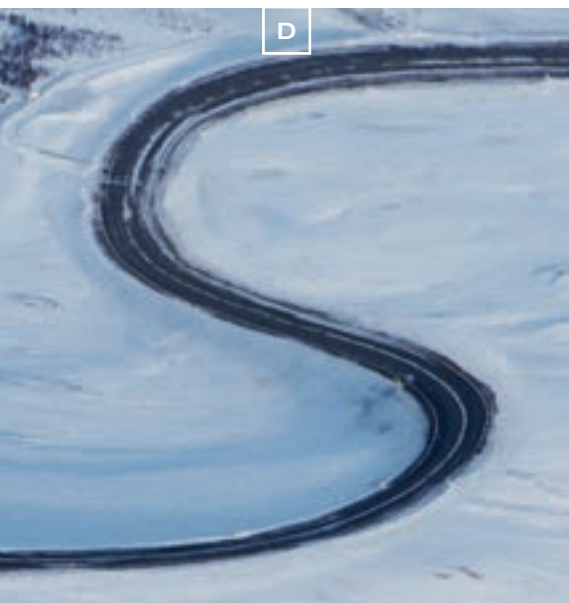

This is how power accelerates.

There is an old school of thought in the automotive world that bigger is better. More horsepower, greater displacement—these were once the hallmark of the industry. Audi, on the other hand, progressed past this antiquated notion of engine design and adopted a system that refines the driving experience. By utilizing a turbocharger, the powerful 2.0-liter engine delivers a broad torque curve and impressive off-the-line acceleration. And since more responsive vehicles breed better performance, the result is an exhilarating driving experience at every turn.

2.0 TFSI® four-cylinder

This 2.0-liter turbocharged DOHC engine produces 220 horsepower and 258 lb-ft of torque, and combines the valvelift system, FSI® direct injection and turbocharging for great power and overall performance.



Performance

The adage “good things come in small packages” has never been more true.

Induction-technology turbocharger

Compressing the airflow to the engine allows more air into the cylinder and, ultimately, more power from each combustion cycle, helping to improve the engine’s power-to-displacement ratio.

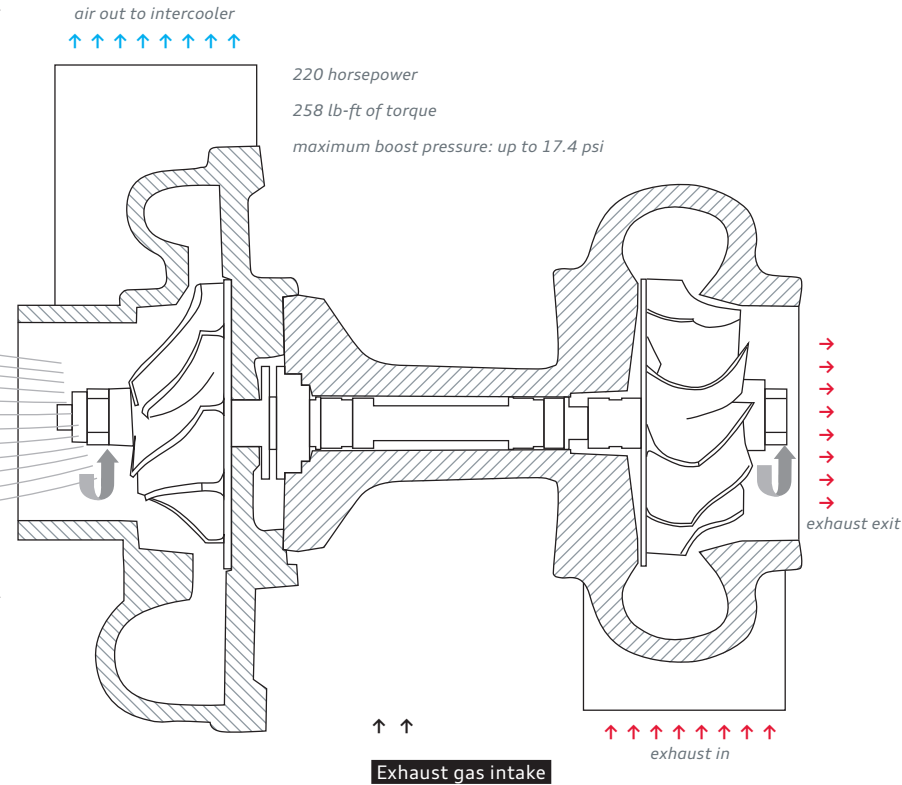

Exhaust gas intake
Exhaust from the engine spins the turbine that is connected by a shaft to a compressor that pressurizes air. The compressor forces this pressurized air into the cylinders at boosted pressures up to 17.4 psi, thus producing more power from a smaller displacement engine.

Eight-speed Tiptronic® automatic transmission

As the perfect compromise between a dedicated manual and an automatic gearbox, the eight-speed Tiptronic® automatic transmission available in the A5 offers eight optimized, carefully chosen gear ratios. Selected automatically or via its console-mounted shifter or steering wheel with available shift paddles, precise shifts are delivered without sacrificing the smooth action of the Tiptronic® automatic. A high final drive ratio allows optimization of lower gears, yet the transmission’s upper range emphasizes cruising at highway speeds.

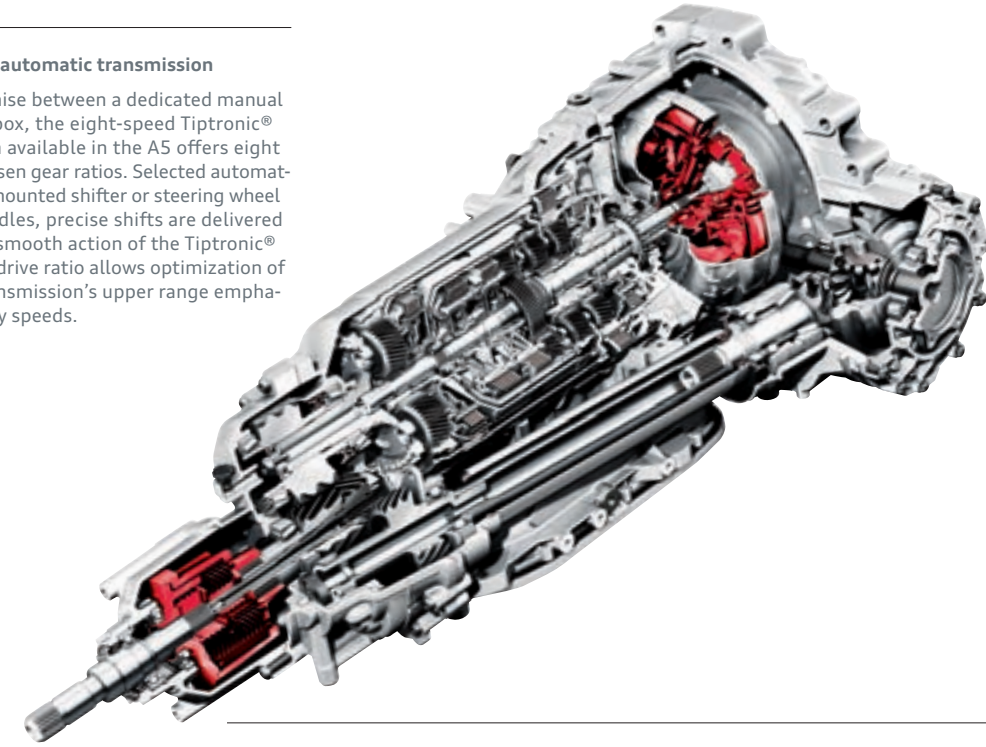

gear	ratio
1ST	4.714:1
2ND	3.143:1
3RD	2.106:1
4TH	1.667:1
5TH	1.285:1
6TH	1.000:1
7TH	0.839:1
8TH	0.667:1
	ratio

Six-speed manual transmission

For drivers who crave engaging and dynamic response, the Audi A5 Coupe presents an available six-speed manual gearbox that delivers power with vintage Audi finesse. Its short throw and precise ratios add a contemporary element for confident performance on the road.

With efficiency comes great power.

The Audi A5 offers two transmission choices that precisely transmit the power produced by the 2.0-liter TFSI engine. With wide gear ratios for smooth shifting and impressive performance, it doesn’t matter which transmission you choose. Available steering wheel-mounted shift paddles for automatic transmissions let you shift up or down with minimal effort, while the six-speed manual transmission gives you the control that performance drivers crave. A shift has been made, and the choice is yours: choose what propels your A5.

A little insight into the things you cannot see.

With a suite of available driver assistance options, we strive to constantly up the ante on driver convenience. Available Audi side assist helps inform you of other vehicles in the lanes next to you, while available Audi adaptive cruise control helps monitor the distance between you and the vehicle ahead, and adjusts your speed appropriately to help keep you moving smoothly. There are also the simple things, like the available parking system, which adds a rear view camera and rear acoustic parking sensors to help ease you into that spot. It's another testament to the effort that Audi puts into helping ensure that you're not the only one keeping an eye on the road.



Audi adaptive cruise control

Everyone has their own comfort zone. The available Audi adaptive cruise control helps maintain a driver-selected distance from the vehicle in front by using a special long-range radar sensor. The system constantly measures the space between your vehicle and the vehicle ahead and helps manage it by automatically adjusting your speed. Once the road ahead is clear, the vehicle effortlessly resumes the previously preset speed, helping to make your drive that much more relaxing.



Driver Assistance

We're solving problems before you even know you have them.

Audi side assist

The available Audi side assist uses radar sensors and two different optical warnings to help keep the driver informed about what is approaching from hard-to-see angles behind and to the side of the vehicle.

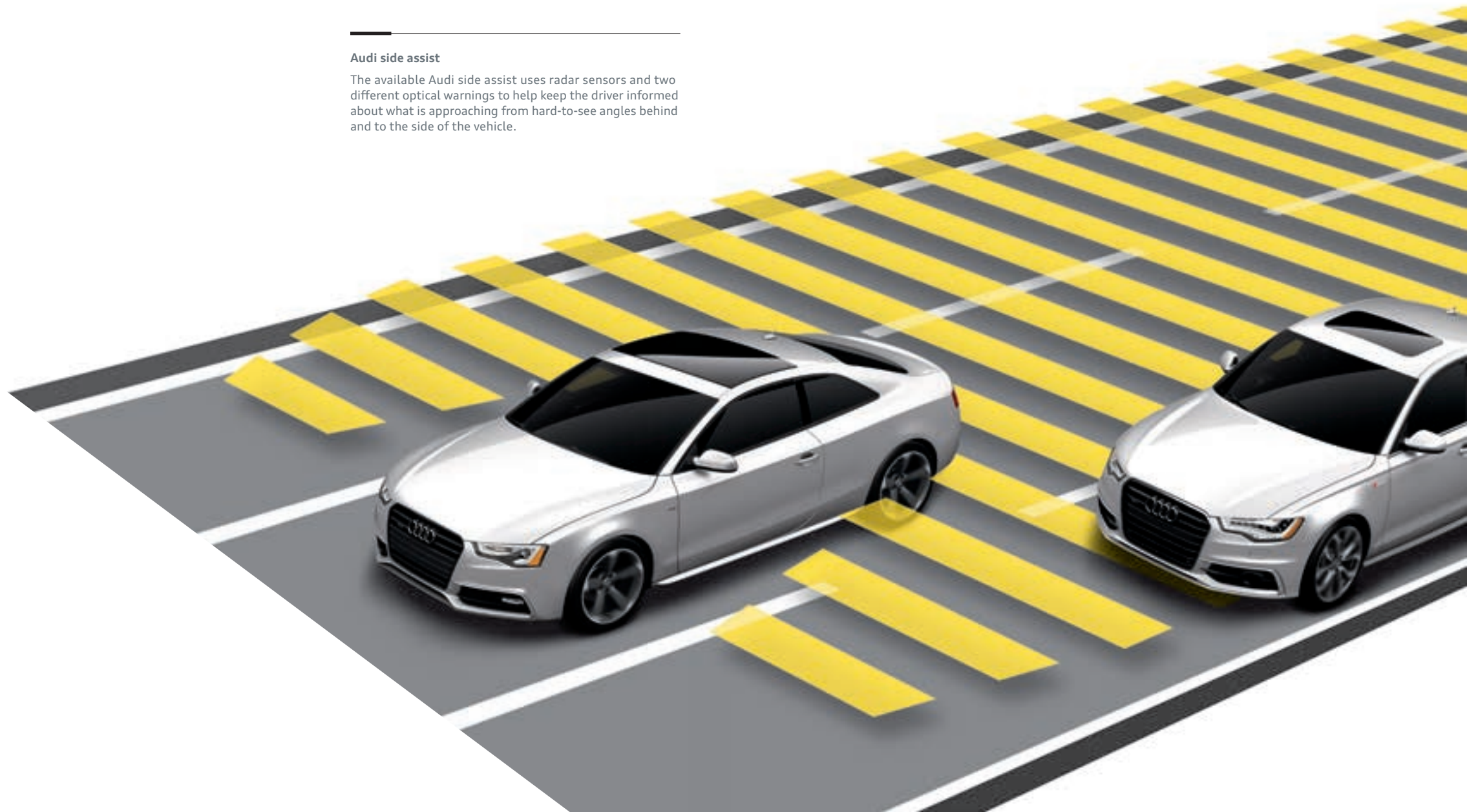

A little give requires a lot of strength.

We decided that, regardless of size, strong should be a more flexible concept. Ultra-high-strength steel helps add a measure of security while enhancing overall handling and performance. Sophisticated airbag technology is designed to deploy airbags based on seat position,¹ while specially constructed crumple zones give way upon impact to help mitigate potential injury in a collision. All of this, combined with the rigidity of laser seam-welded joints that enhance the strength of every Audi we make, helps diminish the impact of an unavoidable event.



Safety

Working to spread a “bend, don’t break” philosophy.



Active rollover protection system

In the unlikely event that your A5 Cabriolet rolls over, sensors deploy two roll bars from hidden compartments in the rear. Reinforced A-pillars up front and safety belt pretensioners also help protect passengers. It’s another way we keep innovative design as high a priority as your safety.

Airbags

Sensors mounted in the front seats monitor your seating position to help ensure that the adaptive front airbags will deploy in the event of a collision.¹ Driver and passenger front seat-mounted thorax side airbags help keep your upper body protected, while knee-level airbags help keep tabs down below. The A5 Coupe even has two rows of Sideguard® head curtain airbags for an added level of protection.¹

¹ Airbags are supplemental restraints only and will not deploy in all crash circumstances. Always use safety belts and seat children only in the rear, using restraint systems appropriate for their size and age.

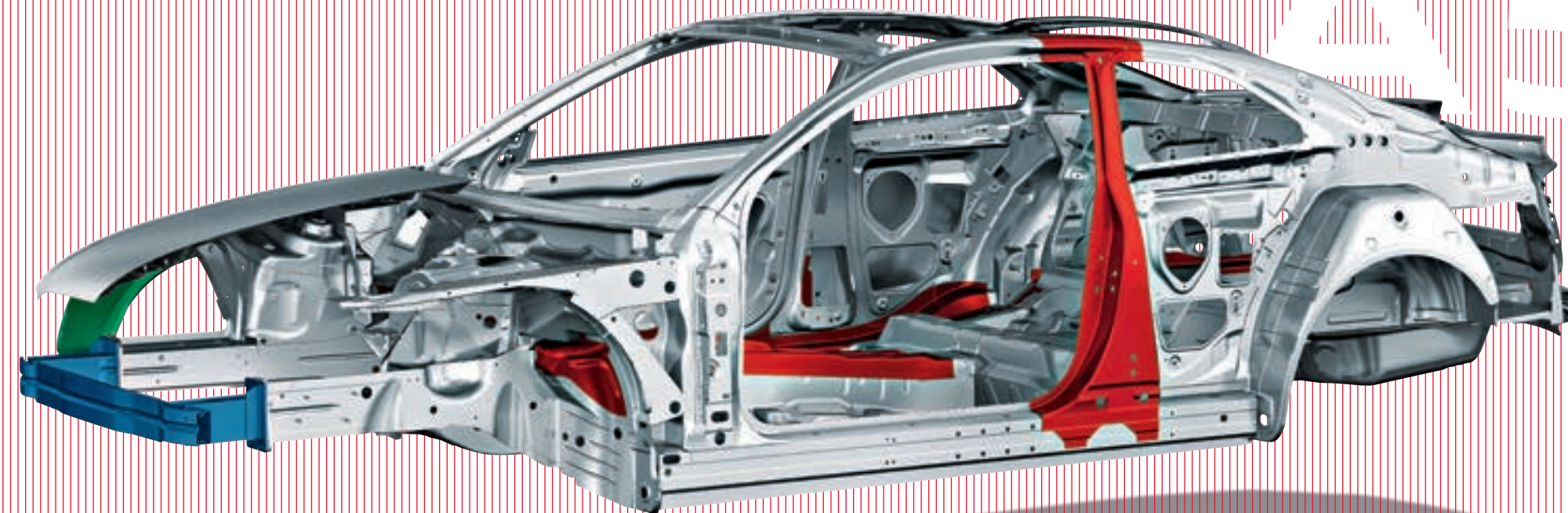

Tailor-made blanks

Developed to make the best possible use of the body’s potential, tailor-made blanks are the result of a special manufacturing process that can help strengthen the upper zone of a B-pillar while mitigating the impact in the lower zone in the event of a side collision.



A5



Crumple zones

Knautschzone may be an ugly word, but it’s a beautiful technology. German for “crumple zone,” this ingenious feature helps dissipate the energy from a collision by spreading the impact forces around the passenger cell and away from its occupants. In doing so, it also enhances the vehicle’s deceleration rate, which helps to further lessen the force of impact.

- sheet aluminum
- extruded aluminum
- ultra-high-strength steel
- cold-formed steel

Get in touch with your inner techie.

We believe intelligence is key to a higher form of luxury. You can see this philosophy fully represented in the available MMI® system. Simply put, it's an intuitive system that intimately connects you to almost every facet of the vehicle. It's the nerve center of your vehicle, allowing you to control virtually every interior function of your Audi with a simplified source control button system. Whether it's MMI navigation plus, or BLUETOOTH® streaming audio, MMI helps you access information with a few easy clicks. And even without it, you can pair your compatible phone with the vehicle for added convenience. With this kind of brainpower onboard, you can leave the little stuff to us, and just concentrate on how good it feels to drive.^{1,2}



MMI System

Putting your needs front and center.

SiriusXM® Satellite Radio

Go ahead. Crisscross the country. We assure you, you'll never run out of entertainment options, with over 150 channels of music, talk, sports and news.¹

Audi media

The media function opens up a world of options when equipped with the MMI navigation plus, allowing you to control the Audi music interface, Secure Digital (SD) card slots, hard disk drive (HDD) audio jukebox or DVD, and BLUETOOTH® streaming audio from a compatible device.^{1,2}

MMI navigation plus

Count on the available advanced navigation system to home in on your destination with stunning precision while putting a little more depth in your journey with help from the available Audi connect®.^{1,2}

BLUETOOTH® wireless technology

Unlock your compatible mobile phone's potential through the MMI system. Simply pair them up and start enjoying near complete control at the touch of a button.



¹ See Infotainment/Technology section of the Featured Content page for important information regarding MMI® navigation plus and required SiriusXM® subscriptions. ² Always pay careful attention to the road, and do not drive while distracted. The features and technologies discussed above are optional, may require an additional subscription with separate terms and conditions, and should be used only when it is safe and appropriate. The Wi-Fi® hotspot feature is intended for passenger use only.

Tell us what you're looking for and we'll deliver you to it.

Don't reach—relax. While touchscreens are seemingly everywhere, they don't need to be in your vehicle. With available Audi connect®, you may never have to reach out again.¹ Thanks to Google Voice™ Local Search, Audi connect allows you to quickly search Google™ by simple voice commands (use only when the car is stationary).^{1,2} The crisp display is mounted farther up, closer to the windshield and near your sight line to the road ahead. For those times when you are feeling tactile, we've placed toggle buttons near the gear shifter, where your hand naturally rests when using them. So while other automobile manufacturers still want you to reach out, we've found a few ways for you to make information a lot more accessible while your hands are on the wheel.¹

POI

Point-of-interest

The point-of-interest search with voice control means that the digital world is with you on every journey.¹

myAudi

myAudi features

Plan travel from your personal computer. Send your desired destinations to your vehicle ahead of time and access your route from your vehicle later.¹

NEWS

News feeds

Stay on top of the news by having headlines and stories delivered right to your MMI® display.¹



Mobile Wi-Fi® hotspot

Provides high-speed connectivity for up to eight passenger devices through an onboard wireless hub.¹



SiriusXM® Traffic

Get traffic information overlaid onto available 3D satellite imagery to visualize a true aerial view of your route, and let the MMI navigation plus system reconfigure your route to help avoid traffic.^{1,3}



Google Earth™ with 3D satellite imagery

With Google Earth™ integration, you'll enjoy 3D satellite imagery, including Google Maps Street View, displayed right on the MMI display.¹



Weather information

Current local conditions and forecasts for your destination can help you prepare for your trip.¹



Google Voice™ Local Search

Simply tell your Audi what you are in the mood for, then let the cloud-processing power of Google™ speech recognition interpret your request and bring up a list of destinations in the area of your choice.^{1,2}



Google Maps Street View

With Google Maps Street View, your vehicle can show you a driver's-eye view of your destination right before you arrive so it's easy to recognize.¹



Parking information

Search for parking in your area of interest, check space availability and set your selection as a destination to help navigate directly to the garage entrance.^{1,4}



City events

Get information about current events, exciting locations and places of interest at your travel destination, current location or other chosen location instantly.¹



Travel info

Discover local landmarks in your area of interest, set them as your destinations, and let your vehicle lead the way as you explore the world around you.¹

¹ Always pay careful attention to the road, and do not drive while distracted. The features and technologies discussed above are optional, may require an additional subscription with separate terms and conditions, and should be used only when it is safe and appropriate. The Wi-Fi® hotspot feature is intended for passenger use only. ² Voice control not available for all Cabriolet models. ³ See Infotainment/Technology section of the Featured Content page for important information regarding MMI® navigation plus and required SiriusXM® subscriptions. ⁴ Parking feature is not available everywhere and requires participation by parking provider.



Sound

Audi is Latin for "listen," so you know we take sound very seriously.

52 Hz

Low note on a kick drum

True bass tones are something you feel more than hear, and when a kick drum hits you with a frequency of 52 Hz, you definitely feel it. Knowing this, Audi sound engineers worked to reproduce sounds at this level for an exceptionally realistic experience.

2,093 Hz

High note on a piano

Even at a frequency of 2,093 Hz, the equivalent of the double high C note found on a piano, the sound system clearly and effortlessly reproduces the sound, giving you front row seats to every symphony.

261 Hz

Singing middle C

At a frequency of around 261 Hz, you'll find middle C. It is around this frequency that much of the brilliantly orchestrated sound is reproduced by the numerous, strategically placed speakers.

Lend us your ear.

It's been said that people only hear what they want to. That what they don't like just goes in one ear and out the other. Well, for those people and everyone else, we've created a sound system that makes every note worthy of your eardrum's full attention. From perfectly sculpted high notes to a crystal clear mid-range to deep-diving lows, the available Bang & Olufsen® Sound System is a veritable orchestra of engineering that fills the cabin with faithfully rendered, thrilling sound. Which shouldn't be surprising at all, considering that Bang & Olufsen® and Audi sound engineers worked tirelessly to craft a perfect acoustic environment, and the ideal delivery system for it. So whether you're the type that wants to be soothed by sound or the type that wants to be inspired by it, we promise, if you take a moment to listen, that what you'll hear will be utterly impossible to ignore.



Bang & Olufsen® Sound System

Dedicated to the idea of "honest music reproduction," Bang & Olufsen® is a sound engineer's dream. Through an available 505-watt system perfectly integrated within your Audi, Bang & Olufsen® is set on transcending the limits of audio technology. By automatically adjusting volume and timbre balance to changing ambient noise levels and offering richly tuned acoustics, you'll hear the truth about how good life can sound in your Audi.

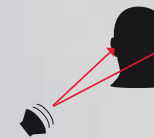

Unlike with high-frequency sounds, the brain cannot detect where low bass frequencies are coming from, making it seem as if the sound is hitting both ears at the same time. Because of this, Bang & Olufsen® sound engineers only had to design one custom-fitted subwoofer to reproduce the kind of deep, cabin-filling bass that brings music to life.



S5

ENGINE // 3.0-liter supercharged TFSI® V6 engine developing 333 hp and 325 lb-ft of torque

DRIVETRAIN // quattro® all-wheel drive, available sport differential, six-speed manual transmission (Coupe only) or an available seven-speed S tronic® dual-clutch transmission

CHASSIS // S5 tuned sport suspension calibration, Audi drive select and available dynamic steering

BRAKES // 13.6" ventilated front disc brakes with S5 logo, 13.0" ventilated rear disc brakes

PERFORMANCE // Top track speed of 155 mph¹; acceleration from 0 to 60 mph in 4.9 seconds (Coupe) and 5.3 seconds (Cabriolet)



Performance as nimble as the thinking behind it.

While the Audi A5 may be everything the devotee of the authentic coupe requires, sometimes even a purist yearns for a little bit more. A supercharged 3.0-liter TFSI® V6 engine sits comfortably under the hood of the Audi S5, producing 333 horsepower and an exhilarating 325 lb-ft of torque, to propel the S5 Coupe to 60 mph in just 4.9 seconds². Experience the heart and soul of Audi performance cars through the sport-tuned suspension that is ready for the street or the track. While most automotive manufacturers want you to upgrade your engine with after-market tricks, we developed a line of vehicles that require only your enthusiasm.

Audi Sport
Truth in Engineering



The story doesn't stop here. There's more on the full range of S, RS, and R8 Audi performance models in the **2015 Audi Sport brochure**. See your dealer or go to audiusa.com for details.

¹ Top track speed is electronically limited in the U.S. Always obey all speed and traffic laws. ² Always obey all speed and traffic laws.

Premium

A5 Coupe and Cabriolet Premium featured highlights

- ▶ Singleframe® grille
- ▶ Xenon plus headlights with LED daytime running lights
- ▶ Automatic headlights
- ▶ Front fog lights
- ▶ LED taillights and rear fog lights
- ▶ Power-adjustable heated exterior side mirrors
- ▶ LED turn indicator lights integrated into the exterior side mirrors
- ▶ Heated windshield washer nozzles
- ▶ Aluminum trim around exterior windows (windshield frame on Cabriolet)
- ▶ Dual exhaust outlets
- ▶ Three-zone automatic climate control
- ▶ Three-spoke multifunction steering wheel
- ▶ Tilt and telescopic manually adjustable steering column
- ▶ Illuminated locking glove compartment
- ▶ Leather-wrapped shift knob
- ▶ Folding and sliding front center armrest with height adjustment
- ▶ Aluminum door sill inlays
- ▶ Front and rear footwell LED lighting
- ▶ Ambient LED interior lighting
- ▶ Power windows with one-touch up/down operation and pinch protection
- ▶ Panoramic tilting sunroof (Coupe)
- ▶ Acoustic folding roof—folds at speeds up to 31 mph (Cabriolet)
- ▶ Leather seating surfaces
- ▶ Ten-way power front seats and four-way power lumbar adjustment for driver
- ▶ Split folding rear seatbacks
- ▶ Audi concert radio with ten speakers and single CD player with MP3 playback capability
- ▶ SiriusXM® Satellite Radio with 90-day trial subscription¹
- ▶ SD card slot with 32GB operating capacity (dual slots if equipped with MMI® navigation plus)²
- ▶ Audi music interface with iPod® integration
- ▶ BLUETOOTH® wireless technology preparation for mobile phone³
- ▶ Garage door opener (HomeLink®)
- ▶ Cruise control with coast, resume and accelerate features

Available packages and stand-alone options

- ▶ MMI® navigation plus package
- ▶ 18" 5-arm dynamic design wheels
- ▶ Heated front seats
- ▶ Dark Brown Walnut Wood decorative inlays
- ▶ Fine Grain Ash Natural Brown Wood decorative inlays



Panoramic tilting sunroof (Coupe)



LED taillights and rear fog lights



Xenon plus headlights with LED daytime running lights

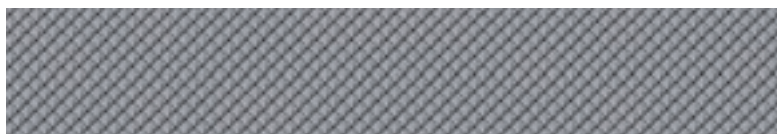

Aluminum Trigon decorative inlays



18" 10-spoke Audi exclusive design wheels with 245/40 all-season tires⁴



Three-zone automatic climate control



Integrated rear spoiler



Three-spoke multifunction steering wheel



Garage door opener (HomeLink®)



¹ SiriusXM® Satellite Radio and Traffic subscriptions sold separately or as a package after trial expires. SiriusXM® Traffic service available in select markets. Subscriptions are governed by SiriusXM® Customer Agreement (see www.siriusxm.com) and are continuous until you call SiriusXM® to cancel. SiriusXM® U.S. Satellite Service available only to those 18 and older in the 48 contiguous U.S.A., D.C. and Puerto Rico (with coverage limitations). ² MMI® navigation plus depends on signals from the worldwide Global Positioning Satellite network. The vehicle's electrical system and existing wireless and satellite technologies must be available and operating properly for the system to function. The system is designed to provide you with suggested routes in locating addresses, destinations and other points of interest. Changes in street names, construction zones, traffic flow, points of interest and other road system changes are beyond the control of Audi of America, Inc. Complete detailed mapping of lanes, roads, streets, toll roads, highways, etc., is not possible, therefore you may encounter discrepancies between the mapping and your actual location. Please rely on your individual judgment in determining whether or not to follow a suggested MMI® navigation plus route. For mapping updates please see your Audi dealer or call 1-800-FOR-AUDI for details. ³ Requires compatible device. ⁴ High-performance tires are designed for better performance and handling in warm climates. When driving in cold, snowy or icy weather, you should equip your vehicle with four all-season or winter tires, which offer better traction under those conditions. We suggest you use the Audi-recommended winter or all-season tires specified for your Audi. High-performance tires also have a lower aspect ratio that aids performance and handling. Driving over rough or damaged road surfaces, as well as debris, curbs and other obstacles, can cause serious damage to wheels, tires, vehicle body and suspension parts. Be careful to avoid road hazards and reduce your speed, especially if your vehicle is equipped with low-profile tires. Please also remember when making your selection that, while these tires deliver responsive handling, they may ride less comfortably and make more noise than others. Finally, these tires may wear more quickly than other choices. It is important that the inflation pressure is regularly checked and maintained at recommended levels.

Premium Plus

The following highlighted features of the A5 Coupe and Cabriolet Premium Plus add to or replace the highlighted features of the A5 Coupe and Cabriolet Premium

- ▶ Power-adjustable, auto-dimming, heated exterior side mirrors with memory
- ▶ S line® exterior appearance
- ▶ Auto-dimming interior rear view mirror with digital compass
- ▶ S line® door sill inlays
- ▶ Driver seat memory
- ▶ Heated front seats
- ▶ Audi advanced key—keyless start, stop and entry¹

Available packages and stand-alone options

- ▶ Comfort Seat package (Cabriolet)
- ▶ Sport package
- ▶ Sport plus package
- ▶ S line® Competition package (Coupe)²
- ▶ Technology package
- ▶ 18" 5-arm dynamic design wheels
- ▶ 19" 10-spoke design wheels
- ▶ Bang & Olufsen Sound System with 14 speakers and 505 watts (12 speakers on Cabriolet)
- ▶ Dark Brown Walnut Wood decorative inlays
- ▶ Fine Grain Ash Natural Brown Wood decorative inlays



S line® exterior appearance



Driver seat memory



Heated front seats

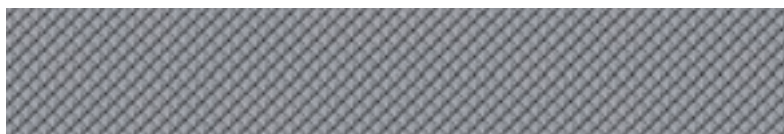

Aluminum Trigon decorative inlays



18" 10-spoke Audi exclusive design wheels with 245/40 all-season tires³



Audi advanced key—keyless start, stop and entry¹



S line® door sill inlays



Auto-dimming interior rear view mirror with digital compass



¹ Some Audi models are equipped with a keyless ignition feature. The details as to how the system works can vary, and Audi owners should consult their owner's literature or an authorized Audi dealer if they have further questions about the operation of this feature. Please note that Audi warns against leaving the vehicle unattended with the engine running, particularly in enclosed spaces. ² Delayed availability. ³ High-performance tires are designed for better performance and handling in warm climates. When driving in cold, snowy or icy weather, you should equip your vehicle with four all-season or winter tires, which offer better traction under those conditions. We suggest you use the Audi-recommended winter or all-season tires specified for your Audi. High-performance tires also have a lower aspect ratio that aids performance and handling. Driving over rough or damaged road surfaces, as well as debris, curbs and other obstacles, can cause serious damage to wheels, tires, vehicle body and suspension parts. Be careful to avoid road hazards and reduce your speed, especially if your vehicle is equipped with low-profile tires. Please also remember when making your selection that, while these tires deliver responsive handling, they may ride less comfortably and make more noise than others. Finally, these tires may wear more quickly than other choices. It is important that the inflation pressure is regularly checked and maintained at recommended levels.

Prestige

The following highlighted features of the A5 Coupe and Cabriolet Prestige add to or replace the highlighted features of the A5 Coupe and Cabriolet Premium Plus

- ▶ Adaptive xenon plus headlights with LED daytime running lights
- ▶ MMI® navigation plus with voice control system¹ (voice control not available on Cabriolet)
- ▶ Audi connect® with six-month trial subscription²
- ▶ Color driver information system
- ▶ Bang & Olufsen Sound System with 14 speakers and 505 watts (12 speakers on Cabriolet)
- ▶ HD Radio™ Technology
- ▶ SiriusXM® Traffic with four-year subscription³
- ▶ BLUETOOTH® streaming audio⁴
- ▶ Audi side assist
- ▶ Parking system with rear view camera

Available packages and stand-alone options

- ▶ Comfort Seat package (Cabriolet)
- ▶ Sport package
- ▶ Sport plus package
- ▶ S line® Competition package (Coupe)⁵
- ▶ Driver Assistance package
- ▶ Audi exclusive line interior package
- ▶ 18" 5-arm dynamic design wheels
- ▶ 19" 10-spoke design wheels
- ▶ Bang & Olufsen Sound System with 14 speakers and 505 watts (12 speakers on Cabriolet)
- ▶ Dark Brown Walnut Wood decorative inlays
- ▶ Fine Grain Ash Natural Brown Wood decorative inlays



MMI® navigation plus with voice control system¹ (voice control not available on Cabriolet)



Parking system with rear acoustic parking sensors

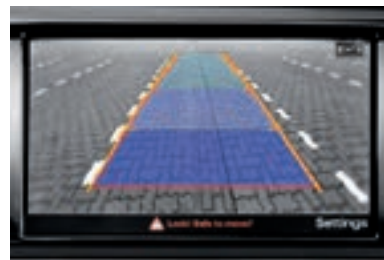

Parking system with rear view camera

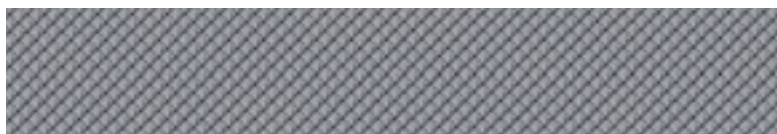

Aluminum Trigon decorative inlays



18" 10-spoke Audi exclusive design wheels with 245/40 all-season tires⁶



Adaptive xenon plus headlights with LED daytime running lights



Bang & Olufsen® Sound System with 14 speakers and 505 watts (12 speakers on Cabriolet)



Audi connect® with Google Earth™ mapping service²



Audi side assist



¹ MMI® navigation plus depends on signals from the worldwide Global Positioning Satellite network. The vehicle's electrical system and existing wireless and satellite technologies must be available and operating properly for the system to function. The system is designed to provide you with suggested routes in locating addresses, destinations and other points of interest. Changes in street names, construction zones, traffic flow, points of interest and other road system changes are beyond the control of Audi of America, Inc. Complete detailed mapping of lanes, roads, streets, toll roads, highways, etc., is not possible, therefore you may encounter discrepancies between the mapping and your actual location. Please rely on your individual judgment in determining whether or not to follow a suggested MMI® navigation plus route. For mapping updates please see your Audi dealer or call 1-800-FOR-AUDI for details. ² Always pay careful attention to the road, and do not drive while distracted. The features and technologies discussed above are optional, may require an additional subscription with separate terms and conditions, and should be used only when it is safe and appropriate. The Wi-Fi® hotspot feature is intended for passenger use only. ³ SiriusXM® Satellite Radio and Traffic subscriptions sold separately or as a package after trial expires. SiriusXM® Traffic service available in select markets. Subscriptions are governed by SiriusXM® Customer Agreement (see www.siriusxm.com) and are continuous until you call SiriusXM® to cancel. SiriusXM® U.S. Satellite Service available only to those 18 and older in the 48 contiguous U.S.A., D.C. and Puerto Rico (with coverage limitations). ⁴ Requires compatible device. ⁵ Delayed availability. ⁶ High-performance tires are designed for better performance and handling in warm climates. When driving in cold, snowy or icy weather, you should equip your vehicle with four all-season or winter tires, which offer better traction under those conditions. We suggest you use the Audi-recommended winter or all-season tires specified for your Audi. High-performance tires also have a lower aspect ratio that aids performance and handling. Driving over rough or damaged road surfaces, as well as debris, curbs and other obstacles, can cause serious damage to wheels, tires, vehicle body and suspension parts. Be careful to avoid road hazards and reduce your speed, especially if your vehicle is equipped with low-profile tires. Please also remember when making your selection that, while these tires deliver responsive handling, they may ride less comfortably and make more noise than others. Finally, these tires may wear more quickly than other choices. It is important that the inflation pressure is regularly checked and maintained at recommended levels.

Packages

Analogous to the progressive nature in which all our vehicles are engineered are the technologies and offerings available in a variety of packages to enhance the experience of driving an Audi vehicle. To prove that luxury has progressed, we invite you to explore the package that best outfits your Audi A5.

MMI® navigation plus package

Available on Premium models

- ▶ MMI® navigation plus with voice control¹
- ▶ Color driver information system
- ▶ HD Radio™ Technology
- ▶ SiriusXM® Traffic with four-year subscription¹
- ▶ BLUETOOTH® streaming audio¹



Comfort Seat package (Cabriolet)

Available on Premium Plus and Prestige models

- ▶ Perforated Milano leather seats
- ▶ 14-way power front sport seats, including four-way power lumbar adjustment
- ▶ Ventilated front seats
- ▶ Head-level heating system

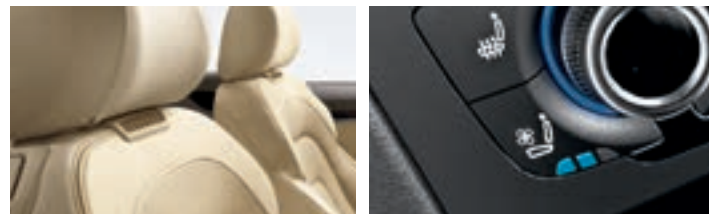

Sport package

Available on Premium Plus and Prestige models

- ▶ Sport suspension calibration
- ▶ Shift paddles (automatic transmission)
- ▶ 14-way power front sport seats, including four-way power lumbar adjustment
- ▶ Audi drive select



Sport plus package

Available on Premium Plus and Prestige models

- ▶ Sport package
- ▶ Gloss Black Singleframe® grille (Coupe)
- ▶ Gloss Black trim around exterior windows (Coupe)
- ▶ Three-spoke multifunction flat-bottom sport steering wheel (with shift paddles on automatic models)
- ▶ Black cloth headliner (Coupe)
- ▶ 19" 5-arm-rotor design Titanium-finished wheels with 255/35 summer performance tires³



S line® Competition package (Coupe)²

Available on Premium Plus and Prestige models

- ▶ Sport package
- ▶ Sport plus package
- ▶ Gloss Black exterior side mirror housings, side sills and rear diffuser surround
- ▶ S line® Competition package exclusive aluminum manual shift knob
- ▶ S line® steering wheel emblem
- ▶ Piano Black decorative inlays
- ▶ Black cloth headliner
- ▶ Black leather/Perforated Alcantara® seating surfaces—S line® embossed



Technology package

Available on Premium Plus models

- ▶ MMI® navigation plus with voice control¹
- ▶ Audi connect® with six-month trial subscription¹
- ▶ Color driver information system
- ▶ HD Radio™ Technology
- ▶ SiriusXM® Traffic with four-year subscription¹
- ▶ BLUETOOTH® streaming audio¹
- ▶ Parking system with rear view camera
- ▶ Audi side assist



Driver Assistance package

Available on Prestige models

- ▶ Dynamic steering
- ▶ Audi adaptive cruise control
- ▶ Audi drive select



Audi exclusive

Audi exclusive line interior package

Available on Prestige models

- ▶ Sport package
- ▶ Piano Black decorative inlays
- ▶ Black cloth headliner
- ▶ Audi exclusive line bicolor Fine Nappa leather seats
- ▶ Leather door armrests and pulls
- ▶ Contrast piping and stitching on seats, steering wheel, armrests, shift boot and floor mats

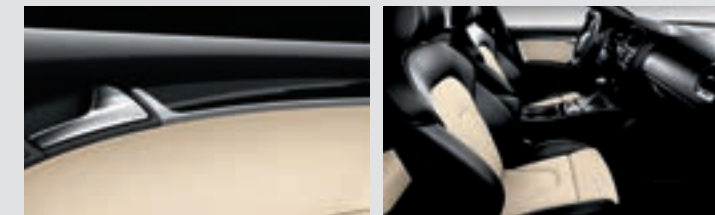

¹ See Infotainment/Technology section of the Featured Content page for important information regarding MMI® navigation plus, required SiriusXM® subscriptions, BLUETOOTH®-compatible device and Audi connect®. Voice control not available for all Cabriolet models.
² Delayed availability. ³ See Options page for important safety information regarding summer performance tires.

Options

In addition to the many packages available for your Audi A5, there are also a host of a la carte options to outfit your vehicle. From a variety of wheel offerings, a premium audio system and elegant interior trims to creature comforts like heated front seats, there's an option to help better complement your lifestyle.



18" 5-arm dynamic design wheels with 245/40 all-season tires¹
(optional on all models)



19" 10-spoke design wheels with 255/35 summer performance tires¹
(optional on Premium Plus and Prestige models)



Dark Brown Walnut Wood decorative inlays (optional on all models)

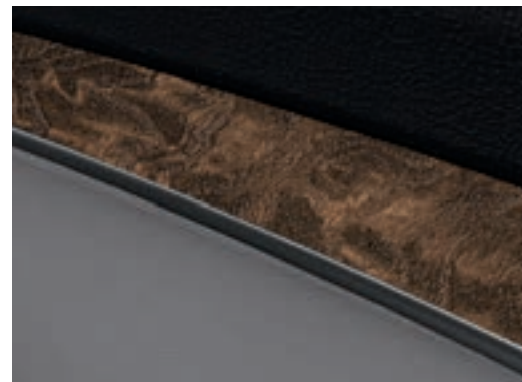

Fine Grain Ash Natural Brown Wood decorative inlays
(optional on all models)



Heated front seats (optional on Premium models)



Bang & Olufsen® Sound System with 14 speakers and 505 watts
(12 speakers on Cabriolet) (optional on Premium Plus models)

¹ High-performance tires are designed for better performance and handling in warm climates. When driving in cold, snowy or icy weather, you should equip your vehicle with four all-season or winter tires, which offer better traction under those conditions. We suggest you use the Audi-recommended winter or all-season tires specified for your Audi. High-performance tires also have a lower aspect ratio that aids performance and handling. Driving over rough or damaged road surfaces, as well as debris, curbs and other obstacles, can cause serious damage to wheels, tires, vehicle body and suspension parts. Be careful to avoid road hazards and reduce your speed, especially if your vehicle is equipped with low-profile tires. Please also remember when making your selection that, while these tires deliver responsive handling, they may ride less comfortably and make more noise than others. Finally, these tires may wear more quickly than other choices. It is important that the inflation pressure is regularly checked and maintained at recommended levels.

Exterior Colors

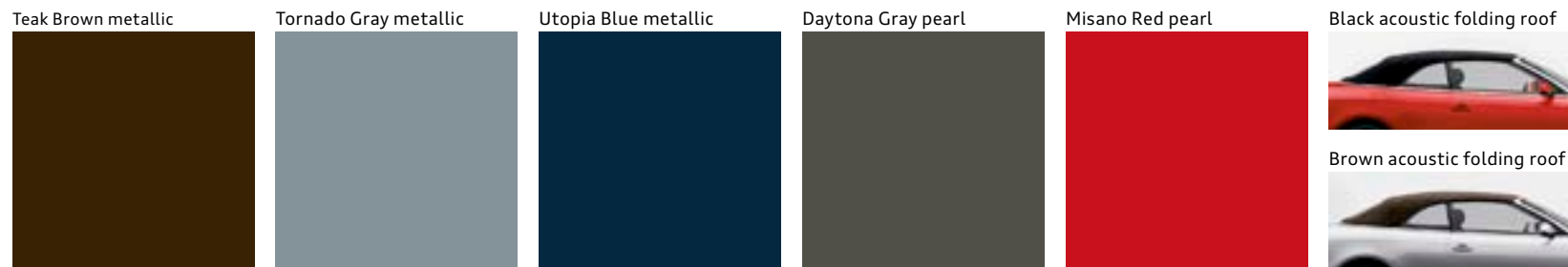
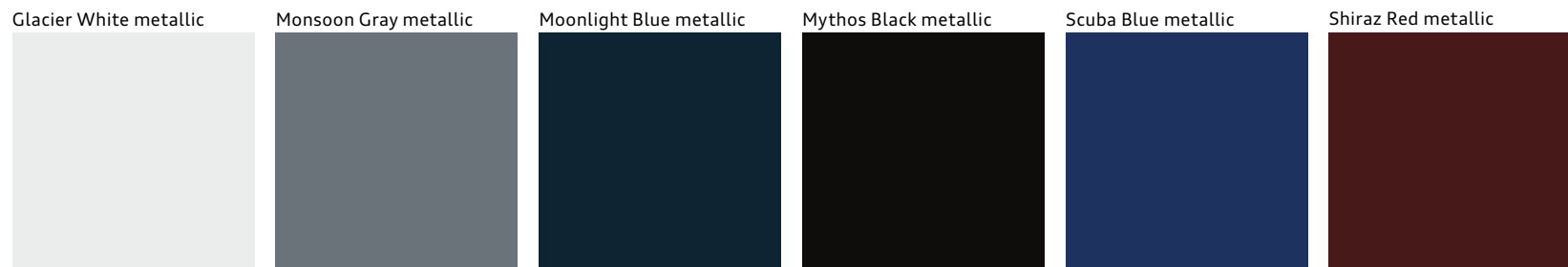
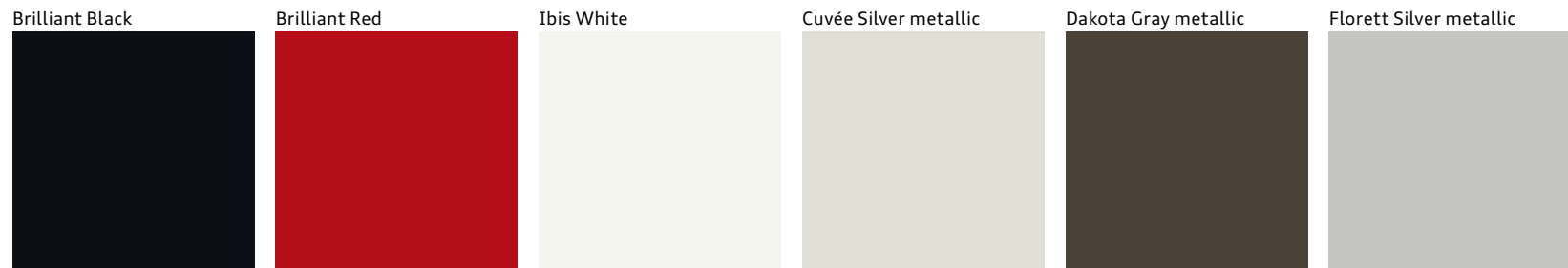

(Cabriolet)

S line® Competition package (Coupe)¹

S line® Competition package (Coupe)¹

Exterior colors, interior colors and decorative inlay options will vary based on model and trim level combination. See your dealer for details.

Seat Selections | Interior Colors

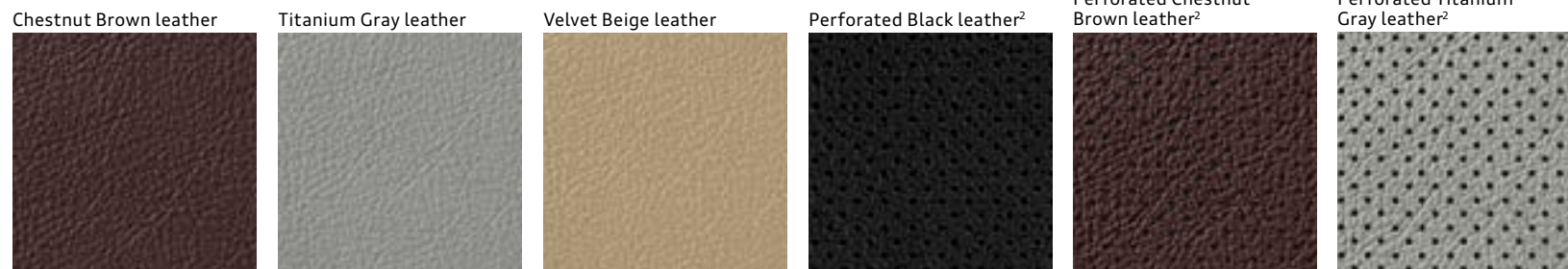

Standard, Sport
Standard, Sport
Standard
Comfort
Comfort
Comfort



Comfort
Audi exclusive line interior package, Sport
Audi exclusive line interior package, Sport (Coupe)
Audi exclusive line interior package, Sport
Audi exclusive line interior package, Sport (Cabriolet)
S line® Competition package, Sport (Coupe)¹

¹ Delayed availability. ² Available in Audi A5 Cabriolet with Comfort Seat package only.

Decorative Inlays

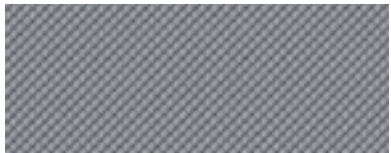

Aluminum Trigon decorative inlays¹

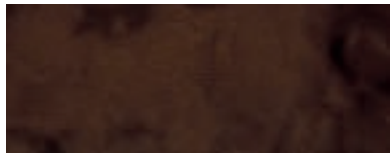

Dark Brown Walnut Wood decorative inlays¹



Fine Grain Ash Natural Brown Wood decorative inlays¹



Piano Black decorative inlays¹

¹ Decorative inlay options will vary based on model and interior color combination. See your dealer for details.

Technical Specifications

Engineering | Performance

	A5 2.0T Coupe	A5 2.0T Cabriolet
Engine type	Four-cylinder	Four-cylinder
Engine block/Cylinder head	Cast-iron/Aluminum-alloy	Cast-iron/Aluminum-alloy
Displacement (cc)/Bore and stroke (mm)	1,984/82.5 x 92.8	1,984/82.5 x 92.8
Horsepower (@ rpm)	220 @ 4,450–6,000	220 @ 4,450–6,000
Torque (lb-ft @ rpm)	258 @ 1,500–4,300	258 @ 1,500–4,300
Compression ratio	9.6:1	9.6:1
Valvetrain	16-valve DOHC with valvelift system	16-valve DOHC with valvelift system
Induction/Fuel injection	Turbocharged/TFSI®	Turbocharged/TFSI®
Acceleration with manual/Tiptronic® transmission (0–60 mph)	6.3/6.1 seconds	—/6.6 seconds
Top track speed ¹	130 mph	130 mph

Transmission | Drivetrain

Six-speed manual transmission with quattro® all-wheel drive (Gear ratios: 1st: 3.778, 2nd: 2.050, 3rd: 1.321, 4th: 0.970, 5th: 0.757, 6th: 0.625, Reverse: 3.333, Final drive: 3.693)	■	—
Eight-speed Tiptronic® automatic transmission with quattro® all-wheel drive (Gear ratios: 1st: 4.714, 2nd: 3.143, 3rd: 2.106, 4th: 1.667, 5th: 1.285, 6th: 1.000, 7th: 0.839, 8th: 0.667, Reverse: 3.317, Final drive: 2.848)	Available	■

Body | Suspension | Chassis

Fully galvanized steel unibody with aluminum front fenders and multistep anti-corrosion protection	■	■
Five-link front suspension	■	■
Trapezoidal-link rear suspension	■	■
Sport suspension calibration (Premium Plus and Prestige)	Available	Available
Ventilated front disc/Solid rear disc brakes (in)	12.6/11.8	12.6/11.8
Electromechanical power steering system	■	■
Dynamic steering (Prestige)	Available	Available
Steering ratio	15.9:1	15.9:1
Turning diameter, curb-to-curb (ft)	37.4	37.4

■ Standard — Not applicable NA Information not available at time of printing

Exterior measurements

	A5 2.0T Coupe	A5 2.0T Cabriolet
Wheelbase (in)	108.3	108.3
Length (in)	182.1	182.1
Height (in)	54.0	54.4
Overall width with mirrors (in)	79.5	79.5
Overall width without mirrors (in)	73.0	73.0
Track front/rear (in)	62.6/62.1	62.6/62.1
Curb weight with manual transmission (lb)	3,583	—
Curb weight with Tiptronic® transmission (lb)	3,682	4,045
Drag coefficient (C _w)	.32	.34

Interior measurements

Head room (in, front/rear)	37.5/36.0	40.0/36.3
Leg room (in, front/rear)	41.3/31.7	41.3/31.9
Shoulder room (in, front/rear)	54.3/52.8	54.3/46.8
Cargo volume (cu ft, rear seatbacks up)	12.2	10.2
Seating capacity	4	4

EPA mileage estimates | Capacities | Emissions

Manual transmission (city/highway/combined) ²	NA	—
Tiptronic® automatic transmission (city/highway/combined) ²	NA	NA
Engine oil (qt)	4.9	4.9
Fuel (gal)	16.1	16.1
Recommended fuel	Premium	Premium
Emissions rating	ULEV II	ULEV II

Audi Sport
Truth in Engineering



Technical specifications and featured content for Audi S5 and RS 5 models can be found in the **2015 Audi Sport brochure**. See your dealer or go to audiusa.com for details.

¹ Top track speed is electronically limited in the U.S. Always obey all speed and traffic laws. ² 2015 EPA estimates not available at time of printing. See www.fueleconomy.gov for updated information. Your mileage and emissions will vary and depend on several factors, including your driving habits and vehicle condition.

Featured Content

Safety Security	Premium	Premium Plus	Prestige
Driver and front passenger dual-stage airbags, front thorax side airbags, knee airbags, and Sideguard® head curtain airbags ¹ (Coupe)	■	■	■
Driver and front passenger dual-stage airbags, knee airbags, and front head/thorax side airbags ¹ (Cabriolet)	■	■	■
Front passenger occupant detection for airbags ¹	■	■	■
Active rollover protection system (Cabriolet)	■	■	■
Safety belt reminder for driver and front passenger	■	■	■
Lower Anchors and Tethers for Children (LATCH) in rear seats (Lower Anchors only on Cabriolet)	■	■	■
Power central locking system with safety unlock feature if airbags deploy	■	■	■
Electronic Stability Control (ESC) with traction control (ASR)	■	■	■
Anti-lock Brake System (ABS) with Electronic Brake-pressure Distribution (EBD) and brake assist	■	■	■
Tire-pressure monitoring system	■	■	■
Electromechanical parking brake	■	■	■
Anti-theft alarm system with immobilizer	■	■	■

Exterior	Premium	Premium Plus	Prestige
Singleframe® grille	■	■	■
Gloss Black Singleframe® grille (Coupe)	—	Available	Available
Xenon plus headlights with LED daytime running lights	■	■	—
Adaptive xenon plus headlights with LED daytime running lights	—	—	■
Automatic headlights	■	■	■
Front fog lights	■	■	■
LED taillights and rear fog lights	■	■	■
Power-adjustable heated exterior side mirrors	■	—	—
Power-adjustable, auto-dimming, heated exterior side mirrors with memory	—	■	■
LED turn indicator lights integrated into the exterior side mirrors	■	■	■
Aluminum trim around exterior windows (windshield frame on Cabriolet)	■	■	■
Gloss Black trim around exterior windows (Coupe)	—	Available	Available
Dual exhaust outlets	■	■	■
S line® exterior appearance	—	■	■
S line® Competition package exterior appearance—Gloss Black exterior side mirror housings, side sills and rear diffuser surround (Coupe) ²	—	Available	Available

Interior	Premium	Premium Plus	Prestige
Three-zone automatic climate control	■	■	■
Three-spoke multifunction steering wheel	■	■	■
Three-spoke multifunction flat-bottom sport steering wheel	—	Available	Available
Shift paddles (automatic transmission)	—	Available	Available
Tilt and telescopic manually adjustable steering column	■	■	■
Auto-dimming interior rear view mirror with digital compass	—	■	■
Illuminated locking glove compartment	■	■	■
Leather-wrapped shift knob	■	■	■
S line® Competition package exclusive aluminum manual shift knob (Coupe) ²	—	Available	Available
Folding and sliding front center armrest with height adjustment	■	■	■
Decorative interior inlays	■	■	■
Front and rear footwell LED lighting	■	■	■
Ambient LED interior lighting	■	■	■
Black cloth headliner (Coupe)	Available	Available	Available
Front and rear floor mats	■	■	■
Power windows with one-touch up/down operation and pinch protection	■	■	■
Panoramic tilting sunroof (Coupe)	■	■	■
Acoustic folding roof—folds at speeds up to 31 mph (Cabriolet)	■	■	■

Seating	Premium	Premium Plus	Prestige
Leather seating surfaces	■	■	■
Leather/Perforated Alcantara® seating surfaces—S line® embossed (Coupe) ²	—	Available	Available
Perforated Milano leather seats (Cabriolet)	—	Available	Available
Audi exclusive line bicolor Fine Nappa leather seats	—	—	Available
Ten-way power front seats and four-way power lumbar adjustment for driver	■	■	■
14-way power front sport seats, including four-way power lumbar adjustment	—	Available	Available
Driver seat memory	—	■	■
Heated front seats	Available	■	■
Ventilated front seats (Cabriolet)	—	Available	Available
Head-level heating system (Cabriolet)	—	Available	Available
Split folding rear seatbacks	■	■	■

■ Standard — Not applicable

¹ Airbags are supplemental restraints only and will not deploy in all crash circumstances. Always use safety belts and seat children only in the rear, using restraint systems appropriate for their size and age. ² Delayed availability.

Featured Content

Infotainment Technology	Premium	Premium Plus	Prestige
MMI® navigation plus with voice control system ¹ (voice control not available on Cabriolet)	Available	Available	■
Audi connect® with six-month trial subscription ²	—	Available (with navigation)	■
Driver information system	■	■	—
Color driver information system	Available (with navigation)	Available (with navigation)	■
Audi concert radio with ten speakers and single CD player with MP3 playback capability	■	■	—
Bang & Olufsen® Sound System with 14 speakers and 505 watts (12 speakers on Cabriolet)	—	Available	■
HD Radio™ Technology	Available (with navigation)	Available (with navigation)	■
SiriusXM® Satellite Radio with 90-day trial subscription ³	■	■	■
SiriusXM® Traffic with four-year subscription ³	Available (with navigation)	Available (with navigation)	■
SD card slot with 32GB operating capacity (dual slots if equipped with MMI® navigation plus) ¹	■	■	■
Audi music interface with iPod® integration	■	■	■
BLUETOOTH® streaming audio ⁴	Available (with navigation)	Available (with navigation)	■
BLUETOOTH® wireless technology preparation for mobile phone ⁴	■	■	■
Garage door opener (HomeLink®)	■	■	■
Three 12-volt power outlets	■	■	■
Audi advanced key—keyless start, stop and entry ⁵	—	■	■
Cruise control with coast, resume and accelerate features	■	■	■
Audi adaptive cruise control	—	—	Available
Audi side assist	—	Available	■
Audi drive select	—	Available	Available
Parking system with rear view camera	—	Available	■
Rain/light sensor for automatic windshield wipers and headlights	■	■	■

■ Standard — Not applicable

¹ MMI® navigation plus depends on signals from the worldwide Global Positioning Satellite network. The vehicle's electrical system and existing wireless and satellite technologies must be available and operating properly for the system to function. The system is designed to provide you with suggested routes in locating addresses, destinations and other points of interest. Changes in street names, construction zones, traffic flow, points of interest and other road system changes are beyond the control of Audi of America, Inc. Complete detailed mapping of lanes, roads, streets, toll roads, highways, etc., is not possible, therefore you may encounter discrepancies between the mapping and your actual location. Please rely on your individual judgment in determining whether or not to follow a suggested MMI® navigation plus route. For mapping updates please see your Audi dealer or call 1-800-FOR-AUDI for details. ² Always pay careful attention to the road, and do not drive while distracted. The features and technologies discussed above are optional, may require an additional subscription with separate terms and conditions, and should be used only when it is safe and appropriate. The Wi-Fi® hotspot feature is intended for passenger use only. ³ SiriusXM® Satellite Radio and Traffic subscriptions sold separately or as a package after trial expires. SiriusXM® Traffic service available in select markets. Subscriptions are governed by SiriusXM® Customer Agreement (see www.siriusxm.com) and are continuous until you call SiriusXM® to cancel. SiriusXM® U.S. Satellite Service available only to those 18 and older in the 48 contiguous U.S.A., D.C. and Puerto Rico (with coverage limitations). ⁴ Requires compatible device. ⁵ Some Audi models are equipped with a keyless ignition feature. The details as to how the system works can vary, and Audi owners should consult their owner's literature or an authorized Audi dealer if they have further questions about the operation of this feature. Please note that Audi warns against leaving the vehicle unattended with the engine running, particularly in enclosed spaces. ⁶ Always obey all speed and traffic laws.

The new method behind cool.

We've never felt the need to "compete," but we don't shy away from a challenge either. While we've designed vehicles for the race-track, we know that sometimes you want the racetrack feel without the need for a pit crew to manage your daily commute. This is part of why we developed the available S line® Competition package. The S line Competition package's already aggressive appearance is accented by Gloss Black exterior side mirror housings, side sills and rear diffuser surround. Inside, you'll find Black leather/Perforated Alcantara® seating surfaces embossed with the S line logo and available S line Competition package exclusive aluminum manual shift knob. You'll feel strapped in and ready for the green flag or the green light.⁵ So take hold and get ready to receive the attention of passers-by and fellow commuters alike.



Accessories

Add distinction, versatility and the ultimate in self-expression with Audi Genuine Accessories. Whether you load the cargo carrier with climbing gear or add a set of stylish new wheels, we have the accessories that will help enhance every facet of your lifestyle. When purchased from an authorized dealer, all pieces are

backed by your vehicle's 4-year/50,000-mile limited warranty or for 12 months/12,000 miles from the accessory purchase date, whichever is greater! If you're looking to personalize or protect the vehicle you love, we have an Audi-designed solution that works for you.



Compact cargo carrier

Your gear won't take up valuable trunk space with our aerodynamic carrier that offers a generous 16.95-cu-ft capacity. Size: 81" long, 30" wide, 15" high.²

Ski and snowboard rack

This rack transports your equipment to the slopes easily and securely. The standard attachment (shown) holds two sets of skis or two snowboards. A deluxe attachment is also available.^{2,3}



A5 all-weather floor mats

Deep-ribbed channeled design helps protect your vehicle's floor and carpeting from water, mud, sand and snow. Black mats are available in sets of two for front or rear. Front mats feature the A5 logo.



19" 5-arm hollow-spoke design wheels

Experience the high-performance beauty of this eye-catching design. The hollow-spoke feature results in lightweight wheels that allow for more precise handling. Shown in Black, also available in Silver or Anthracite.

19" 15-spoke design wheels

An impressive, clean drop-center deep-dish design makes these 15-spoke design wheels the perfect complement to the your A5.



Valve stem caps

Emblazoned with the iconic Audi rings, these handsome caps complement the unique design of the wheels on your A5 or S5.

Rear wing (A5 Coupe only)

This sleek, aerodynamic appointment augments the already stylish A5 rear view.



S5 all-weather floor mats

Deep-ribbed, channeled design helps protect your vehicle's floor and carpeting from water, mud, sand and snow. Black mats are available in sets of two for front or rear. Front mats feature the Audi S5 logo.



S5 Alu-optic trim package

For the S5 Cabriolet and Coupe, the package includes two red or carbon fiber "Supercharged" fender badges, plus Aluminum-optic side sill blades that match the side mirrors and mount between the wheel wells.

Other accessories

Audi Genuine Alloy Wheels

Strike the perfect balance between breathtaking design and awe-inspiring performance with Audi Genuine Alloy Wheels. Audi experts have meticulously designed these wheels especially for each Audi model. They're engineered to the highest standards and endure rigorous testing to help ensure long-term quality. Experience eye-catching style that is yours and yours alone. Nothing enhances the bold, dynamic look of your Audi vehicle faster.

Audi TravelSpace Transport Accessories

For every season and every getaway, Audi takes you there. Never leave the necessary gear behind. Be ready for any journey with Audi TravelSpace Transport Accessories. The list includes bike racks, ski racks, a variety of water sports equipment carriers and various sizes of cargo carriers. Wherever you go, make sure everything fits with a variety of intelligent and innovative solutions. Accessories designed for your active, passionate lifestyle.

Audi Genuine Electronics Accessories

The illuminating technology that graces each Audi vehicle provides the inspiration for Audi Genuine Electronics Accessories. Similarly, all of these accessories are impressively advanced and inspiring. Our audio options let you enhance your listening pleasure. Other accessory options help promote more convenient travel. All are designed and tested to help ensure compatibility with the vehicle's electrical systems, allowing you to enjoy every aspect of Audi technology with almost all your senses. Demand the best and drive with added confidence.

Audi Guard Comfort and Protection Accessories

Help protect what you love. Audi Guard Comfort and Protection Accessories offer functional, practical items that help keep your Audi in pristine condition. Choose from such useful items as trunk liners that help make clean-up quick and easy, or an easy-to-use storage cover that helps shield the vehicle. Use them all to help reduce wear and tear and keep the vehicle looking like new—inside and out. All are engineered to stringent Audi standards, so you can be assured of their quality and durability.

Audi Guard Car Care Products

Audi vehicles deserve the very best, and this is it: the only car care line specifically designed for Audi. Audi Guard Car Care Products provide gentle cleansing formulas and special tools to help give all interior and exterior surfaces the finest in cleaning and protection. Our shampoos and waxes undergo testing for cleaning performance, change in luster and material compatibility. For the ultimate in shine and sparkle, trust Audi Guard. Pristine, perfect.

¹ Audi Genuine Accessories purchased from an authorized Audi dealer are covered for the greater of: (1) the accessory limited warranty period (12 months or 12,000 miles, whichever occurs first) from the time of purchase; or (2) the remainder of the Audi New Vehicle Limited Warranty period (4 years or 50,000 miles, whichever occurs first). See your authorized Audi dealer for details. ² All roof-rack system attachments require the base carrier bars. All attachments sold separately. ³ Recreational equipment and sporting equipment not included.

Note: A word about this brochure. Audi of America, Inc., believes the specifications in this brochure to be correct at the time of printing. However, specifications, standard equipment, options, fabrics, and colors are subject to change without notice. Some equipment may be unavailable when your vehicle is built. Please ask your dealer for advice concerning current availability of standard and optional equipment, and your dealer will verify that your vehicle will include the equipment you ordered. Vehicles in this brochure are shown with optional equipment. See your dealer for complete details on the Audi New Vehicle Limited Warranty, twelve-year limited warranty against corrosion perforation, and Audi 24/7 Roadside Assistance. (Roadside assistance coverage provided by Road America in the U.S. Certain conditions apply; see your dealer for details.) Tires supplied by various manufacturers. "Audi," all model names, "Audi connect," "Audi Sport," "e-tron," "FSI," "MMI," "quattro," "Sideguard," "Singleframe" and the Singleframe grille design, "S line," "S tronic," "TFSI," "Truth in Engineering," "ultra," and the four rings logo are registered trademarks of AUDI AG. "Alcantara" is a registered trademark of Alcantara S.p.A. "Bang & Olufsen" is a registered trademark of Bang & Olufsen. The BLUETOOTH word mark and logos are owned by the Bluetooth SIG, Inc., and any use of such marks by AUDI AG is under license. "Google," "Google Earth" and "Google Voice" are trademarks of Google Inc. "HD Radio" and the HD Radio logo are proprietary trademarks of iBiquity Digital Corporation. "Hemelink" is a registered trademark of Johnson Controls Technology Company. "iPod" is a registered trademark of Apple Inc. "SiriusXM" and all related marks and logos are trademarks of Sirius XM Radio Inc. and its subsidiaries. "TDI" is a registered trademark of Volkswagen AG. "Tiptonic" is a registered trademark of Dr. Ing h.c. F. Porsche AG. "Wi-Fi" is a trademark of the Wi-Fi Alliance. All other trademarks are the property of their respective owners. Some European models shown.

2015 | A5 Audi of America

Audiusa.com

Facebook.com/Audi

AoA1515484



© 2014 Audi of America, Inc. Printed in the U.S.A.