



A8

Audi A8 | A8 L | A8 L W12
Audi S8

Vorsprung durch Technik **Audi** 



Fascination

4	Audi A8	18	Audi A8 L W12
14	Audi A8 L	24	Audi S8

Technology

32	Innovations	42	Intelligent performance
34	Audi ultra	44	hybrid
36	Audi connect	46	Dynamics
38	quattro®	48	Assistance systems
40	Audi Matrix LED headlights	50	Complexity

Equipment

54	S model	79	Lights
56	Engines	80	Design
58	Audi design selection	80	Operation
62	Audi exclusive	82	Comfort
66	Paint finishes	86	Transport
68	Wheels/tyres	87	Safety
70	Seats/seat upholstery	87	Assistance systems
74	Leather packages/headlining/Audi design selection	89	Infotainment
76	Inlays	91	Audi Extended Warranty
78	Technology		

Other

92	Audi Genuine Accessories	100	Standard/optional equipment
94	Technical data	108	The fascination of Audi
98	Dimensions		

Dialogue: Audi QR codes

Experience Audi even more directly: download a QR app to your smartphone and then scan the QR code or follow the given link in your browser.



The equipment for the vehicles illustrated in the Fascination section can be found on page 107.
The fuel consumption and CO₂ emission figures as well as the efficiency classes can be found from page 94 onwards.

Design

The art of progress. Beautifully expressed in visual form. In an exceptional vehicle. The new Audi A8. Awe-inspiring and sporty, while staying true to one clear principle: concentration on the essential. Not a single line without a function. Distinctively structured surfaces. Exclusive materials. All finished to a supreme standard. And aspiring to something very special – brilliance down to the last detail.

Brilliant details.
Flawlessly styled and timeless.

The fuel consumption and CO₂ emission figures as well as the efficiency classes can be found on page 94.

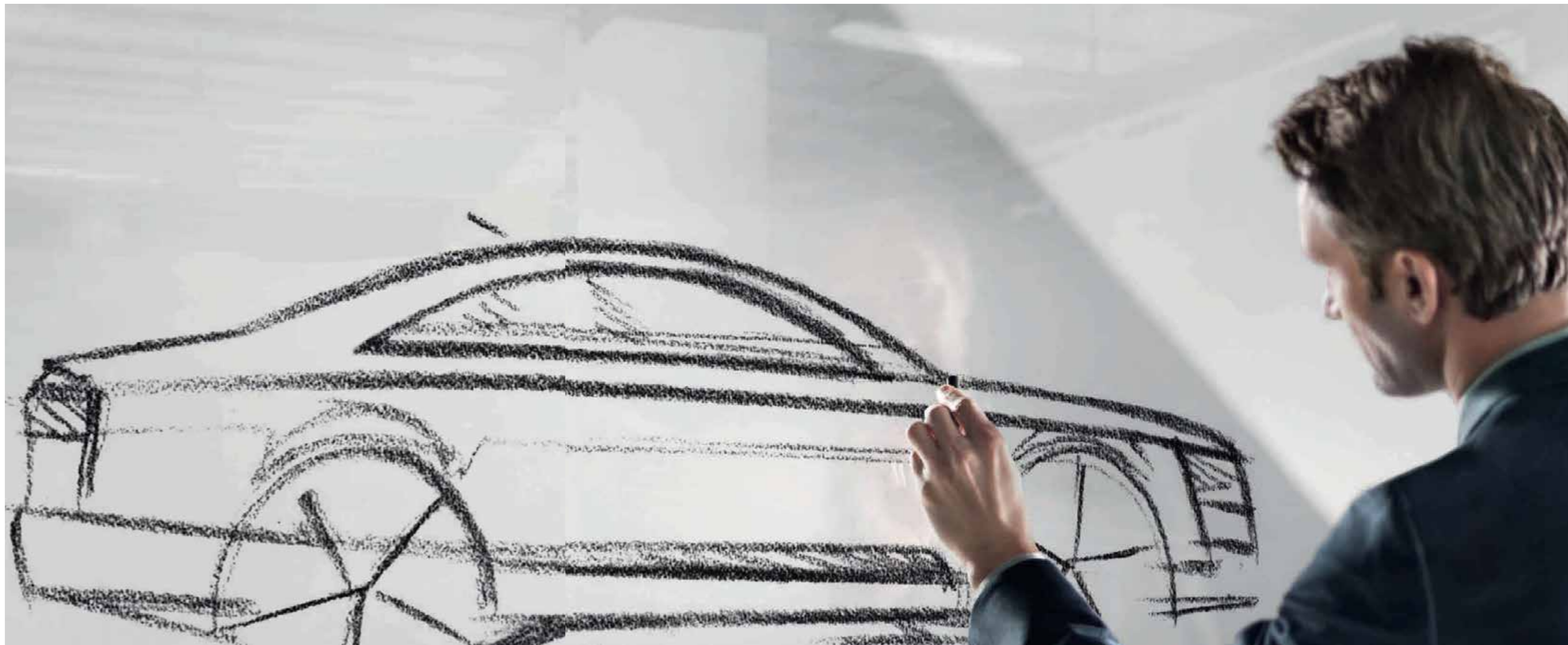



Design



The fuel consumption and CO₂ emission figures as well as the efficiency classes can be found on page 94.

Brilliant design.
Awe-inspiring and dynamic.

Design



The fuel consumption and CO₂ emission figures as well as the efficiency classes can be found on page 94.



**Brilliant
charisma.**
Fascinating
and pioneering.

Design



Comfort



**Brilliant
comfort.**
Exclusive and
authentic.



Comfort



1 2

Comfort



Welcome aboard the new Audi A8. A place where lavish spaciousness is blended with exquisite ambience. Choice materials lend a palpable sense of exclusivity. Top-class workmanship sets new standards. And innovative technology entertains and delights.

Such as the MMI® (1) with its clear layout and elegant design. And which can be operated perfectly with the optional MMI navigation plus with MMI touch (2). Or the optional head-up display (3) that provides eye-level information at all times. The new Audi A8. Designed for complete and utter comfort.



Comfort

The new Audi A8 L. Supreme power and poise on the outside. And room in abundance on the inside. This is thanks to a wheelbase 13 centimetres longer than on the new Audi A8. The result is convincing: even more exclusive space.

Brilliant space.
Elegant and ample.



The fuel consumption and CO₂ emission figures as well as the efficiency classes can be found on page 94.

Comfort

Comfort that invites you to take a seat. Thanks to the larger rear doors. And noticeably more space in the interior. The new Audi A8 L. Allow yourself and your ideas all the room you need. Enjoy increased legroom in the rear. For even more relaxed travel or concentrating even better while working. Surrounded by upholstery and trim that is truly in a class of its own: Unicum leather*. Vegetable tanned. Breathable. Beautifully soft and yet water- and dirt-repellent, too. Full of characteristic features. Unique. Tangible. Mirroring your own personality. In every detail.

The fuel consumption and CO₂ emission figures as well as the efficiency classes can be found on page 94.



*For information on when this feature will be available, please contact your Audi partner.

Dynamics

Impressive performance. 368 kW of power. 625 Nm of torque. Palpable in every driving scenario. 0 to 100 km/h in 4.6 seconds. Achieved with poise and composure, thanks to the exceptionally smooth-running 12-cylinder engine. The new Audi A8 L W12: proof that there truly is power in serenity.

**Brilliant
power.
Thrilling
and serene.**



Design

Styling accents which make all the difference. Which emanate strength. Discreetly. Integrated harmoniously into the overall work of art.

Brilliant details in chrome and stainless steel. The Singleframe with close-mesh grille structure and W12 emblem. At once distinctive and elegant. Air inlets with chrome inserts. Exterior mirrors with additional integrated chrome trim. Sophisticated radiance included. Audi Matrix LED headlights as standard. And as an option: impressive 20-inch forged aluminium wheels in 15-spoke structured design, partly polished.





Take your seat for a journey into a different dimension. In comfort seats featuring exquisite leather upholstery. Relax. Enjoy the 4-zone deluxe automatic air conditioning. Or the soothing massage function. In the optional electrically adjustable relaxation seat in the rear. Enjoy the fascinating sensation of space. Complete with LED ambient lighting. Luxury in a new light. Unique. Unmistakable. The new Audi A8 L W12.

Design



Charisma. Pure power. And technology of the highest standard. All combined in one of the sportiest saloons around. The new Audi S8. Dynamic. Self assured. Visibly progressive. With innovative Audi Matrix LED headlights as an option. Excitingly sporty with a new brilliance.

**Brilliant
technology.
Emphatically
sporty.**



Attention to detail. With a sporty interpretation. With S8-specific 21-inch wheels as an option. Emphatically dynamic. A statement packed with power and confidence. In typical S8 fashion. Three-dimensionally architected Singleframe. Dominantly defined air inlets. The new Audi S8. Expressive. Exclusive. Fascinating. A unique experience. Even before you get in.

Brilliant facets.
Strikingly dynamic.



The fuel consumption and CO₂ emission figures as well as the efficiency class can be found on page 95.



The fuel consumption and CO₂ emission figures as well as the efficiency class can be found on page 95.

Dynamics

High-performance athlete with the S factor. 382 kW that respond spontaneously. And thrill. From 0 to 100 km/h in 4.1 seconds. A fascinating build-up of power. An athletic 650 Nm of torque, from just 1,700 rpm. Impressive performance, intelligently controlled. Thanks to Audi cylinder on demand technology. Reduced fuel consumption. Lower emissions. Combined with a thoroughly brilliant performance. The new Audi S8. Vorsprung durch Technik.

**Brilliant
performance.
Breathtakingly
athletic.**



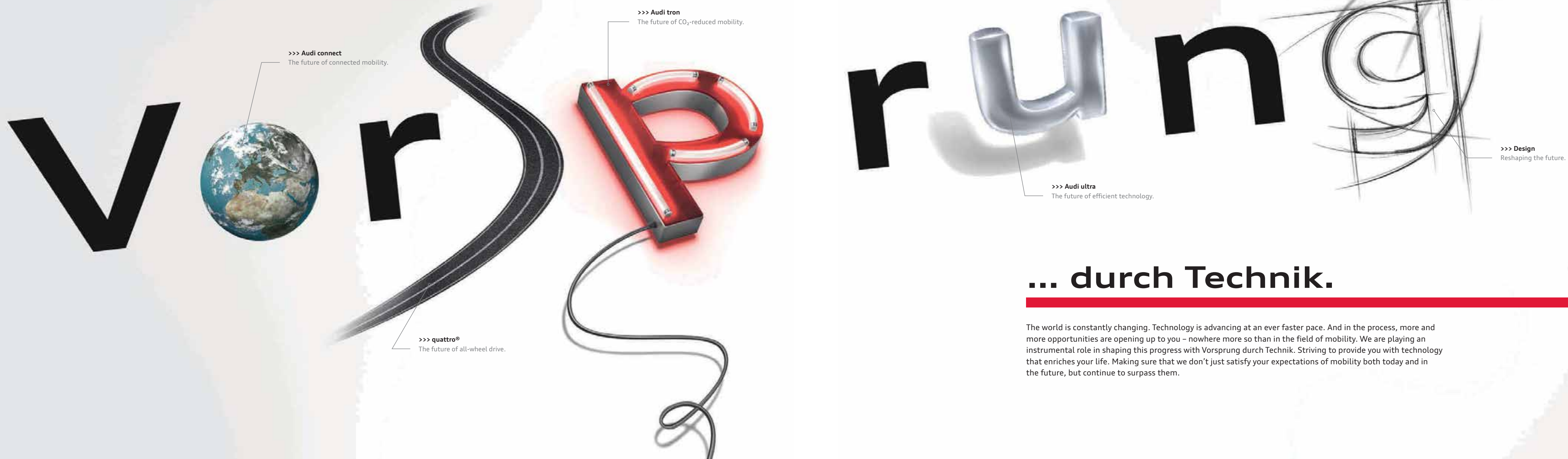

>>> **Audi connect**
The future of connected mobility.

>>> **Audi tron**
The future of CO₂-reduced mobility.

>>> **quattro®**
The future of all-wheel drive.

>>> **Audi ultra**
The future of efficient technology.

>>> **Design**
Reshaping the future.

... durch Technik.

The world is constantly changing. Technology is advancing at an ever faster pace. And in the process, more and more opportunities are opening up to you – nowhere more so than in the field of mobility. We are playing an instrumental role in shaping this progress with Vorsprung durch Technik. Striving to provide you with technology that enriches your life. Making sure that we don't just satisfy your expectations of mobility both today and in the future, but continue to surpass them.

Audi ultra

Perfectly combined.

The future of efficient technology.

Building an Audi is an extremely complicated business. And yet a simple principle applies for all models: all vehicle components interlock precisely in order to produce emission-reducing synergies. What started in accordance with this principle at the end of the 1980s with Audi lightweight construction and the revolutionary Audi Space Frame (ASF®) is now known as the reversal of the weight spiral: every lightweight component has an impact on other components, which can in turn be made smaller. In this way, existing forms and materials are continuously being improved with regard to their functionality, the lowest possible weight and their production process. With the goal of building vehicles that are even more efficient and make more sparing use of resources. At the same time, more and more efficiency technologies are being built into an Audi. These include recuperation and the start-stop system. Not to mention progressive, efficient high-tech engines. For greater driving dynamics, high compression, more efficient combustion and lower CO₂ emissions. All this is known as Audi ultra. Today and in the future – towards CO₂-reduced mobility.

>>> Aerodynamics

Less drag, more efficiency. Thanks to the consistently aerodynamic styling of the vehicle's lines, its underbody and spoiler edges – in order to achieve the best possible form for aerodynamic efficiency. Not forgetting tyres with reduced rolling resistance. All tested in the Audi wind tunnel at up to 300 km/h.

>>> Recuperation

Braking that leads to even more efficient driving. With brake energy recovery (recuperation). Part of the kinetic energy produced when braking and coasting is temporarily stored in the vehicle's battery and then used when accelerating. Depending on the driving cycle, this can save up to 3% fuel.

>>> Lightweight expertise

Less weight. More savings, power and endurance. Audi lightweight technology. What started with lightweight body construction has now made its way into nearly all areas, combining innovative materials such as aluminium, carbon fibre and magnesium, intelligent design principles and resource-saving manufacturing processes into an overall concept.

>>> Transmission expertise

Improved efficiency thanks to improved transmission ratios. A higher torque output makes longer ratios possible, especially in higher gears. For excellent pulling power at low engine speeds. This reduces fuel consumption without impacting on performance or sportiness.

>>> Engine expertise

Powerfully and efficiently driven. By Audi ultra with efficiency technologies in the engine sector. Such as Audi cylinder on demand and the Audi valvelift system, which both reduce the amount of energy consumed by the engine. Or clean diesel technology, which can help to reduce emissions.

Mobility & navigation



Point-of-interest (POI) search with voice control
in the Google™* database



Traffic information online
complements the dynamic route guidance with real-time traffic flow information for individual stretches of road



Fuel prices
the cheapest filling stations at your destination or in the vicinity



Parking information
help with looking for car parks and multi-storeys including price details where known. Up-to-date information on vacant spaces is also displayed provided such information is available.

Communication



Wi-Fi hotspot
connects your mobile devices to the internet



If you want to experience the full diversity of Audi connect, scan this QR code using your smartphone. Or follow this link in your browser: www.audi.com/audiconnecta8



Country information
The legal regulations for a specific country, such as speed limits or whether it is compulsory to carry a high-visibility vest, can be called up at any time in the MMI at the press of a button.



Navigation with Google Earth™* and Google Street View™*
uses high-resolution aerial and satellite images, photos and address information to guide you to your destination even more easily



myAudi – your personal control centre
provides you with password-protected access to www.audi.com/myaudi where, following a one-off registration, you are able to select and manage the services supported by Audi connect as desired and configure them from the comfort of your own home. Destinations can be entered via www.audi.com/myaudi or from a mobile device using the MMI connect app or Google Maps™*.

* Google and the Google logo are registered trademarks of Google Inc.

Availability, screen display and the cost of services vary depending on the country, model, device and tariff. For further legal information and notes on use, please see page 89 or visit www.audi.com/connect. The fuel consumption and CO₂ emission figures as well as the efficiency classes can be found from page 94 onwards.

Audi connect.

Audi connect

The future of connected mobility.

The world presents you with countless possibilities. Audi connect enables you to make the most of many of them in digital form directly from your new Audi A8. At the push of a button. Tailored to you. Thanks to myAudi and the services supported by Audi connect in your new Audi A8. In places all over the world. Intuitively, easily and conveniently.

Infotainment



Weather
forecasts and maps for the required destination



Audi music stream
access to global radio stations via smartphone app and Wi-Fi, plus access to your smartphone's media library



News online
text and images about current world events



City events
provides you with up-to-date information about events – e.g. at your destination



Travel information
offers you sightseeing information – with function for importing destination to navigation system

Have the road completely under control, thanks to permanent distribution of the drive force to all four wheels. Variably controlled by the centre differential. Always as the situation demands. Experience handling stability, dynamism and agility as never before and combat the effects of over- and understeer with quattro with optional sport differential. For increased traction and improved propulsive power. Tame any road. And always keep your eyes set on where you're heading. In bends. On straights. Over any surface. For a fascinating experience that sticks. To the road – and in your mind.



quattro®
**Stick to
the road.**

With quattro®.



Audi Matrix LED headlights

See well.

Darkness is relative. The optional Audi Matrix LED headlights turn night into day. The all-new headlight technology produces a light colour similar to that of daylight. Bends are anticipated to illuminate them more clearly. Other road users are detected and the light distribution of your new Audi A8 adapts according to the situation. This is all made possible by an array of sensors and a camera. As well as dimmable LEDs in an innovative arrangement – which, incidentally, are quite a sight in their own right.



Audi Matrix LED headlights won't thrill you only at night. The new lighting technology is quite a spectacle during the day, too, sometimes appearing as light points, sometimes as a dynamic light strip. Individually controllable LEDs. Perfectly adapted to the situation in hand. Showing the way ahead. An impressive sight, time and time again.

The fuel consumption and CO₂ emission figures as well as the efficiency classes can be found from page 94 onwards.

Look good.

Intelligent performance

Maximum power. Put to maximum use.

Every movement originates from something. Something that set it off, an idea. The engines for your new Audi A8 can also be traced back to an initial spark of inspiration: higher power with lower fuel consumption. These apparently conflicting aims are reconciled in two revolutionary drive technologies: TDI® and TFSI®. Get acquainted with both of them. And then opt for the drive system that you feel most moved by.



The fuel consumption and CO₂ emission figures as well as the efficiency classes can be found from page 94 onwards.



TDI®

With their combination of direct injection and turbocharging, Audi TDI engines promise exceptional performance – thanks to their high torque output over the entire engine speed range with constant power build-up. They are renowned for being fuel-efficient and for reducing emissions. But they are incredibly dynamic too – letting you get the maximum out of any road.



TFSI®

Audi TFSI engines attain a particularly high compression rate. The result: outstanding efficiency combined with optimum performance. Substituting supercharging for cubic capacity has the effect of considerably reducing engine size and weight – while performance remains as impressively dynamic as ever. For power delivery that will win you over from the word go.

Audi cylinder on demand

Even cylinder heads can be intelligent, as Audi cylinder on demand proves. Four of the TFSI engine's eight cylinders automatically shut down in the partial-load range. This helps to lower fuel consumption at the same time as reducing emissions. And without the switchover even being noticed or impairing the driving dynamics.



hybrid

Brake to accelerate.

Extend the lead with every use of the brakes. Invest braking energy in range. Stored first in a lithium-ion battery. Then put to sustainable use. Experience efficient mobility. Purely on electric power if you so wish. Up to 3 kilometres at a constant 60 km/h. And even up to 100 km/h for a short period. Completely emission-free when coasting. When the vehicle is in overrun, the combustion engine is switched off and only the force of its kinetic energy is used. Even at speeds of up to 160 km/h. This can be additionally felt by high-torque dynamics when boosting. Just as soon as the combustion engine and electric motor work together. For faster acceleration, higher flexibility and greater driving enjoyment.



>>> Combustion engine

Among the hybrid engine versions in the new Audi A8, the 2.0 litre TFSI engine is at once both efficient and powerful. The 155 kW engine has increased torque, direct fuel injection, supercharging and the Audi valvelift system. In conjunction with the electric motor, which is also a high-torque unit, the dynamism produced is the equal of any other drive type.

>>> Electric motor

Traction motor, alternator and starter in one: the compact and lightweight 40 kW electric motor in the new Audi A8 hybrid and A8 L hybrid. It is connected to the crankshaft via a separating clutch, thus ensuring that the available power is transmitted directly. This parallel hybrid concept delivers convincing drive-off performance and acceleration in just about every driving situation. Together, the combustion engine and electric motor deliver an output of 180 kW.

>>> Lithium-ion battery (including battery cooling)

The lithium-ion battery in the new Audi A8 hybrid and A8 L hybrid allows you to drive purely on electricity for a certain period. It determines the range and output of the hybrid drive, and its high energy density means significantly more power. Its low weight and space-saving design are also bound to impress. Including active battery cooling, which improves the availability of the hybrid system and prolongs its operating life.

>>> adaptive air suspension
The electronically controlled air suspension acts individually at each of the four wheels and makes sure that the handling characteristics are barely affected, even when carrying heavy loads.

>>> Audi drive select
Audi drive select lets you adjust the driving characteristics of the A8 to suit your requirements. At the push of a button. Sportier, more comfortable, more balanced, more economical or even individually tailored as you please. It's entirely up to you.

>>> Dynamic steering
The dynamic steering enhances handling and driving comfort with speed-sensitive control of the steering ratio.

>>> Electromechanical power steering
The speed-sensitive power steering conveys a precise steering feel even at high speeds, helps you to countersteer and makes light work of parking.

>>> adaptive air suspension sport
Depending on the mode, the sport version of the air suspension lowers the ride height by up to 10 mm compared to adaptive air suspension and has even stiffer damping.

>>> tiptronic
The 8-speed automatic transmission with Dynamic Shift Program (DSP) ensures faster gear changes without any perceptible break in propulsive power.

>>> quattro®
The permanent all-wheel-drive system distributes the drive forces to each individual wheel according to the driving situation for extra traction and dynamic performance.

>>> quattro® with sport differential
The quattro permanent all-wheel drive with electronically controlled sport differential guarantees superb agility and thrilling driving dynamics.

>>> Ceramic brake*
The ceramic brakes fitted at the front and rear axles ensure excellent braking performance in any driving situation.

Dynamics

Dynamics

that will take a hold of you.

Get in. Buckle up. Start the engine. Wherever you're heading, enthralling driving dynamics will power you there. For as you know, the world is your oyster when you get behind the wheel of your new Audi A8. You decide the direction. The driving style. The pace. And you enjoy the satisfaction of knowing you have plenty in reserve. More than enough to get the very best from every drive.

The fuel consumption and CO₂ emission figures as well as the efficiency classes can be found from page 94 onwards. You can find out which equipment features are standard or optional in your model by referring to the index starting on page 100.

>>> Audi pre sense basic

initiates preventive occupant protection measures in the event of an impending accident

>>> Camera-based speed limit display

recognises speed limits and notifies you of them via the driver information system and head-up display

>>> adaptive cruise control with Stop&Go function and Audi pre sense front

monitors the traffic ahead and automatically maintains a constant distance wherever possible

>>> Audi Matrix LED headlights

track the road ahead and illuminate it according to the situation with their innovative LED layout for even greater safety

>>> Audi active lane assist

helps you to keep in lane by means of gentle steering intervention when lane boundary markings are detected

>>> Night vision assistant

improves convenience at night thanks to its integrated thermal imaging camera, highlighting any pedestrians and larger wild animals detected

>>> Audi side assist including Audi pre sense rear

helps you when changing lanes and initiates preventive protection measures when an impending rear-end collision is detected

Assistance systems

Wherever you're heading, peace of mind will be your constant companion.

With the assistance systems in your new Audi A8.

Each drive is different. Yet they all have one thing in common – the feeling of being protected that you get from every Audi. All driver assistance systems in your new Audi A8 help you during your journey and guarantee even greater comfort when you're on the road. Get to know the most important driver assistance systems.

>>> Head-up display

projects key information onto the windscreen at eye level so there is no need to take your eyes off the road

>>> Parking system plus with 360 degree camera

provides a better overview for parking and manoeuvring by offering a choice of different camera angles all around the vehicle

>>> Park assist with display of surroundings

helps you to manoeuvre in and out of parking spaces by performing steering actions autonomously

>>> Audi connect

Use all the services supported by Audi connect with the MMI – quickly and easily. The intuitive operation of the MMI makes accessing the internet remarkably straightforward.

>>> Navigation

Let yourself be guided to your destinations with even greater ease by the 3D map view and three-dimensional display of places of interest and landmark buildings.

>>> Car

Control and alter driver assistance systems, vehicle settings as well as climate control and service functions quickly and easily using the MMI radio plus.

>>> Media

Browse through the covers of your music collection on all available media sources such as inserted SD cards, Audi music interface, CDs or DVDs.

>>> MMI® navigation plus with MMI touch

The MMI navigation plus with MMI touch in the new Audi A8 makes operating the individual components of the Multi Media Interface even easier. The built-in touchpad next to the rotary/push-button control can even be operated using just one finger.

>>> Phone

Make phone calls safely and easily using the hands-free facility: simply select the number to dial from your contacts in the MMI or enter the number intuitively via the MMI touch.

Simplicity**The MMI® – intelligent, individual, intuitive.**

Streamlined. Simple. Logical. The world of mobile infotainment completely redefined: the Multi Media Interface (MMI). Phoning, navigating or surfing the internet via Audi connect: all highly intuitive, highly functional and highly convenient – not least thanks to voice control. With the MMI in your new Audi A8, everything will be child's play for you.

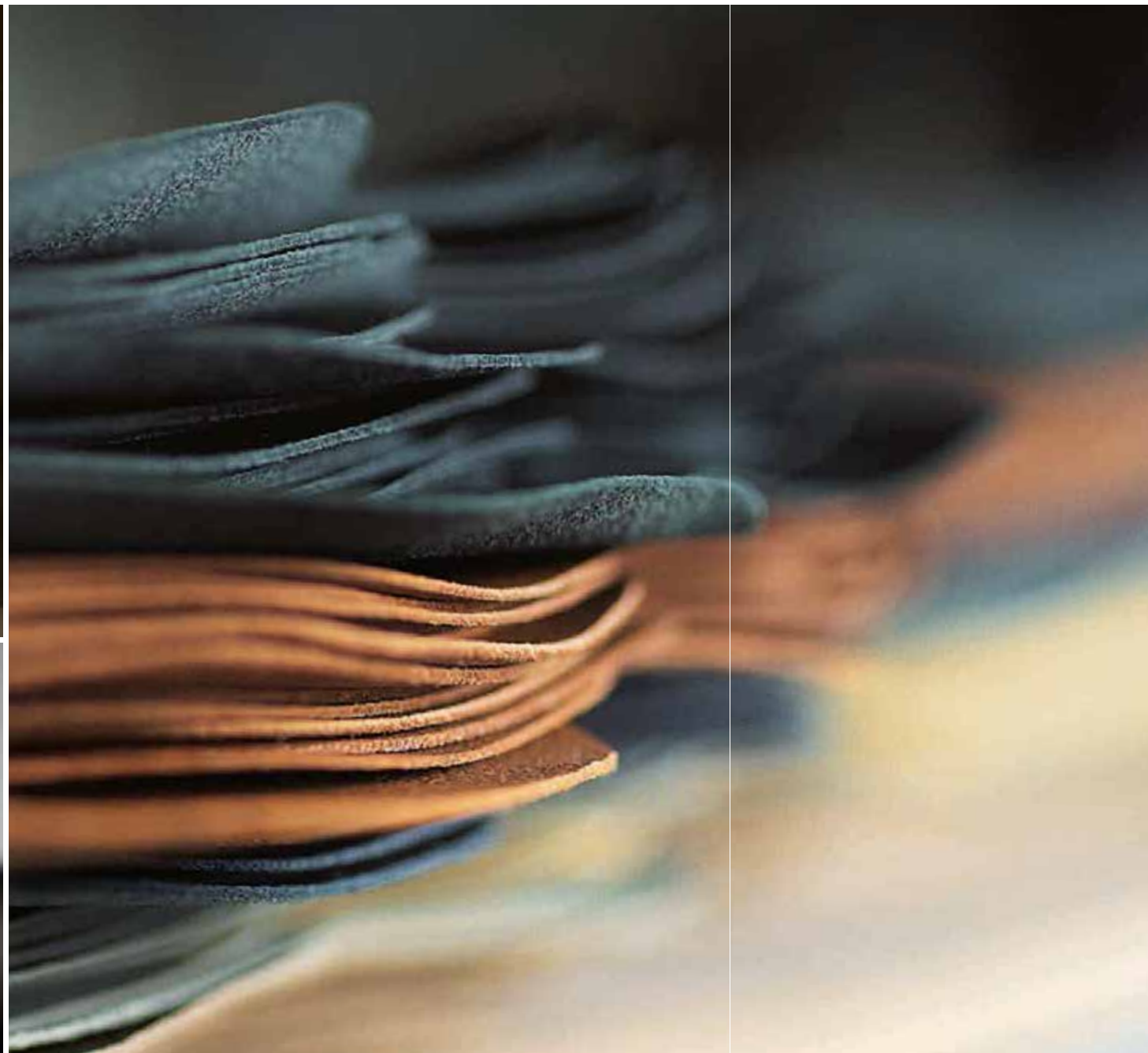

As unique as you are. Equipment options.

Sportiness, comfort, design, functionality – whatever you demand of your Audi, a wealth of equipment options is available to meet your needs. Here you will see just how much attention we pay to detail. And to quality that you can appreciate with all your senses. From exquisite inlays and the extended range of interior colours to superior quality leather: in an Audi A8 you can enjoy not just innovative technology, but luxurious craftsmanship beyond your expectations.

See and feel the sportiness. Even while stationary.

S stands for sportiness. The new Audi S8 is impressive proof of that. An extensive range of S-specific equipment ensures dynamic looks, sporty comfort and superb performance. And that S factor can be enhanced even more with a range of optional features that you will find just as palpably exciting.



The fuel consumption and CO₂ emission figures as well as the efficiency class can be found on page 95.

| S8-specific equipment

Cast aluminium wheels in 5-parallel-spoke design (S design)
size 9 J x 20 with 265/40 R 20 tyres*

Exterior mirror housings
in aluminium look

Audi Singleframe

radiator protective grille in platinum grey with horizontal double chrome struts. With chrome-plated Audi rings in the centre and S8 badge

Bumpers

in S design with blade in aluminium look at the front and diffuser insert in platinum grey, edged with two-layer blade in aluminium look at the rear

Exhaust tailpipes

dual-branch design with 2 oval chrome surrounds on both left and right

Model name/logo

S8 logo on the Audi Singleframe, on the luggage compartment lid, on the illuminated door sill trims, on the front brake callipers, on the sport leather steering wheel and in the rev counter. quattro logo on the dashboard on the passenger side. "V8 T" logo on the front wings

Door sill trims with aluminium inlays
with S8 logo, illuminated

Pedals and footrest in stainless steel
underline the sporty character of the S8

Engine start-stop button, S-specific
with red ring; the engine is started and switched off via the engine start-stop button in the centre console; the key only needs to be carried with you.

S-specific instrument cluster

grey dials, white needles and S8 logo in the rev counter. With controllable lighting, coolant temperature display, fuel gauge, rev counter with digital clock, speedometer with disproportionate display and electronic odometer/trip odometer, displays for radio frequency, outside temperature and tank range, warning and control lights, maintenance interval display

S8-specific analogue clock with grey dial

Upper/lower inlays

Carbon Atlas/brushed aluminium, silver

Selector lever in carbon Atlas

with shift-by-wire technology. In conjunction with Audi design selection Vermont brown in piano finish, black

Multifunction sport leather steering wheel in 3-spoke design with shift paddles in aluminium look
with S8 emblem and S-specific stitching

quattro® with sport differential
with S8-specific tuning

adaptive air suspension sport
with S8-specific tuning

Dynamic steering

with S8-specific tuning

Brake callipers

painted black, with S8 emblem

| S8-specific optional equipment

Cast aluminium wheels in 5-triple-spoke design (S design)
size 9 J x 21 with 265/35 R 21 tyres*

Cast aluminium winter wheels in 5-parallel-spoke design (S design)
size 9 J x 20 with 265/40 R 20 tyres*

S-specific paint finish in the special colour Daytona grey, pearl effect, additional paint finishes in selected standard/optional colours

S8-specific Audi design selection Vermont brown with inlays in carbon twill, copper

Seat upholstery in Valcona leather, lunar silver/steel grey
with square perforations and diamond-patterned stitching

*You will find specifications on the technical characteristics of tyres on page 97.

The right driving force for every personality.

It doesn't matter which Audi engine you choose, they all have high compression ratios, highly efficient combustion and outstanding efficiency. In short, they deliver more power whilst using less fuel and producing fewer emissions.



4.2 litre TDI engine



4.0 litre TFSI engine



6.3 litre FSI engine

TDI®

The Audi TDI engines provide plentiful torque across the entire engine speed range and deliver consistent levels of power with the customary fuel efficiency, whilst also producing fewer emissions. The 3.0 TDI clean diesel quattro, for example, has a power output of 190 kW, a regulated top speed of 250 km/h and accelerates from 0 to 100 km/h in 5.9 seconds.

- ▶ A8 3.0 TDI clean diesel quattro (190 kW)
- ▶ A8 4.2 TDI clean diesel quattro (283 kW)

TFSI®

The Audi TFSI engines offer outstanding efficiency and improved performance whilst at the same time retaining their dynamism. The 4.0 TFSI quattro in the new Audi A8, for example, has a power output of 320 kW, enabling the car to accelerate from 0 to 100 km/h in 4.5 seconds and reach a regulated top speed of 250 km/h.

- ▶ A8 3.0 TFSI quattro (228 kW)
- ▶ A8 4.0 TFSI quattro (320 kW)
- ▶ S8 4.0 TFSI quattro (382 kW)
- ▶ A8 hybrid 2.0 TFSI (155 kW)

FSI®

The Audi W12 engine combines superb acceleration and powerful torque with exceptionally quiet operation. The new Audi A8 L W12 6.3 FSI quattro has an impressive power output of 368 kW and accelerates from 0 to 100 km/h in 4.6 seconds. Its regulated top speed is 250 km/h.

- ▶ A8 L W12 6.3 FSI quattro (368 kW)

The fuel consumption and CO₂ emission figures as well as the efficiency classes can be found on page 94 onwards.

As unmistakable as you: the Audi design selection.

The Audi design selection offers you an attractive choice of interior design packages featuring exclusive materials and colours. Our designers have combined inlays of fine woods or carbon and brushed aluminium with exquisite leather seats featuring attractive contrasting stitching. First-class comfort functions complete the exclusive range of Audi design selections. All the items in the equipment packages can be found on page 75.



Audi design selection sycamore grey

Enjoy the exclusive combination of refined interior colours, special materials and comfort-oriented equipment. You will find the comfort seats in Valcona leather, sycamore grey with accordion pleats, contrasting stitching and piping in brass gold, a pleasure to sit in at any time. The headlining, upper pillar trim and sun visors are in Alcantara, snow white. The upper inlay in fine grain ash, natural pearl grey and lower inlay in brushed aluminium, silver provide harmonious finishing touches in the interior.



Audi design selection Balao brown

Comfort seats, headlining and trims are offered in specially coordinated colour shades: Balao brown and snow white. Inlays in fine grain ash, natural balsamic brown and brushed aluminium, silver provide refined accents.



Audi design selection Vermont brown

Refined interior colours accentuate the elegant ambience, whilst special materials give you a tangible sense of comfort. This is assured by the comfort sport seats in Valcona leather, Vermont brown with accordion pleats, contrasting stitching and piping in granite grey. The headlining, upper pillar trim and sun visors in Alcantara, lunar silver (optionally available in Alcantara, black) complete the harmonious atmosphere.

You have an exclusive character. So why shouldn't your Audi have one too?

That the Audi exclusive range aspires to exclusivity is already evident from its name. Selected décors and coloured leather can be combined with customised paint finishes from the large selection of Audi exclusive colours to suit your own personal preferences. So you can highlight your car's exceptional character to even better advantage. Your Audi partner and the Audi exclusive Studio of the Audi Forum Neckarsulm await your wishes.



A8 L with Audi exclusive customised paint finish in saddle brown, pearl effect

Audi exclusive leather upholstery and trim (package 4) in magnolia/chestnut brown

Comfort sport seats, front in Valcona leather, magnolia; stitching, accordion pleats and seat side bolsters in chestnut brown

Inlays in piano finish, black

Audi exclusive carpet and floor mats



The selector lever in leather, colour-coordinated with your choice of interior colour, sits pleasantly softly in the hand. The inlays in piano finish, black create a sporty yet elegant look. The exquisite ambience is rounded off by the comfort sport seats in magnolia with accordion pleats and stitching on seat side bolsters and head restraints in chestnut brown. The shaped seat side bolsters provide for comfortable lateral hold, the seat centre panels in diamond-patterned stitching for pleasant seating comfort.

These are just a few ideas for how you can customise your new A8. Find out more: your Audi partner and the Audi exclusive Studio of the Audi Forum Neckarsulm await your wishes.



The fuel consumption and CO₂ emission figures as well as the efficiency classes can be found on page 94.

| Extract from the range of Audi exclusive paint finishes



Sand beige, pearl effect

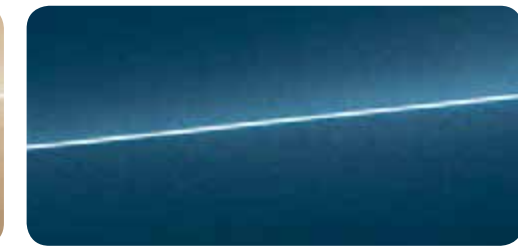

Palace blue, pearl effect



Audi exclusive customised paint finishes
Individual choice of colour

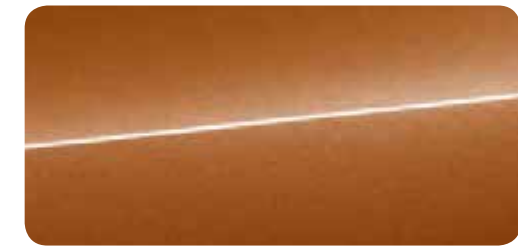

Ipanema brown, metallic

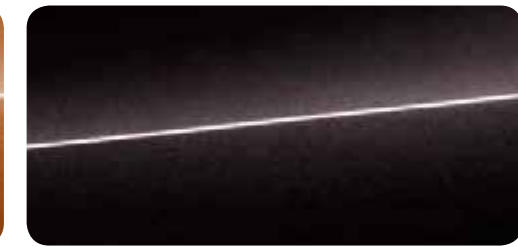

Saddle brown, pearl effect

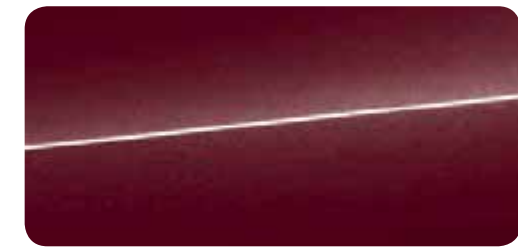

Classic red, pearl effect



Mamba black, metallic

| Extract from the range of Audi exclusive leathers



Valcona leather, alabaster white



Valcona leather, powder beige



Valcona leather, saddle brown



Valcona leather, classic red



Valcona leather, magnolia



Valcona leather, Havana brown



Valcona leather, chestnut brown



Valcona leather, jet grey



Valcona leather, sand beige



Valcona leather, cognac



Valcona leather, crimson red



Valcona leather, cloudy grey

| Extract from the range of Audi exclusive inlays



Valcona leather, smoky blue



Modrone, gold



Tamo ash, natural dark brown



Piano finish, black



Valcona leather, night blue



Vavona, bronze



Fine grain myrtle, nutmeg



Valcona leather, Iceland green



Fine grain ash, nougat



Oak, sepia

Seat upholstery optionally also in Alcantara (except crimson red)

Your Audi is not just painted once. But four times.

When you choose a paint colour, choose one that best reflects your own personality. But regardless of which colour you opt for, you can count on the outstanding quality of our painting process. Though no thicker than a human hair, the layer of paint on an Audi is actually made up of four different coats. So not only do you look radiant in your new Audi A8, the car is also optimally protected from environmental influences and wear. For its entire lifetime.



| Solid paint finishes



Ibis white



Brilliant black

| Metallic paint finishes



Havana black, metallic



Oolong grey, metallic



Floret silver, metallic

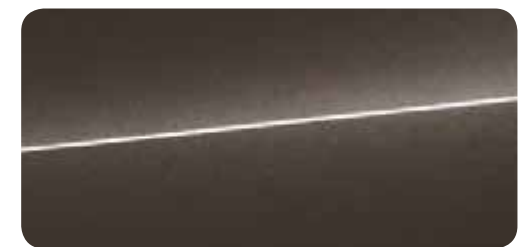

Argus brown, metallic



Monsoon grey, metallic



Glacier white, metallic



Moonlight blue, metallic



Cuvée silver, metallic

The model-specific standard and optional equipment can be found in the index on page 100 onwards.
The fuel consumption and CO₂ emission figures as well as the efficiency classes can be found on page 94 onwards.

Exterior
Paint finishes Wheels/tyres

| Pearl effect paint finishes



Phantom black, pearl effect

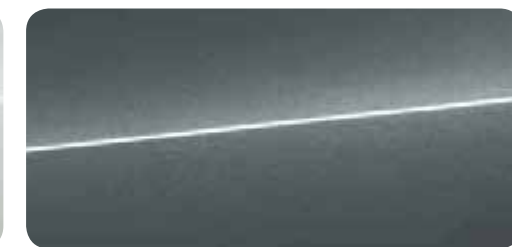

Daytona grey, pearl effect

| Audi exclusive



Audi exclusive customised paint finishes
From quattro GmbH.
An extract from the range of Audi exclusive paint finishes can be found on page 64.



The perfect connection between an Audi and the road: Audi wheels and tyres.

Audi tests its wheels and tyres especially carefully, to be sure you have a good feel for the road from the outset. Before a tyre can become an Audi tyre, it has to undergo a series of tests. This is the only way of guaranteeing that each tyre meets Audi's high quality standards and is perfectly tailored to each specific vehicle. It means you can be sure that both tyre and wheel offer maximum quality, service life and safety. Whichever design you choose.

|Wheels



Forged aluminium wheels in 6-arm design
size 8 J x 17 with 235/60 R 17 tyres*



Cast aluminium wheels in 10-spoke V design
size 8 J x 18 with 235/55 R 18 tyres*



Cast aluminium wheels
in 10-arm turbine design (hybrid design)
size 8 J x 18 with 235/55 R 18 tyres*



Cast aluminium wheels in 5-arm design
size 9 J x 19 with 255/45 R 19 tyres*,
(also available with run-flat tyres)



Cast aluminium wheels
in 10-spoke Y design, partly polished
size 9 J x 19 with 255/45 R 19 tyres*,
(also available with run-flat tyres)



Cast aluminium wheels
in 10-arm turbine design (hybrid design),
contrasting grey, partly polished
size 9 J x 19 with 255/45 R 19 tyres*



Cast aluminium wheels
in 15-spoke design, partly polished
size 9 J x 19 with 255/45 R 19 tyres*,
(also available with run-flat tyres)



Aluminium technology wheels
in 10-arm design, iridium/contrasting grey
size 9 J x 20 with 265/40 R 20 tyres*



Forged aluminium wheels
in 10-parallel-spoke design, partly polished
size 9 J x 20 with 265/40 R 20 tyres*



Cast aluminium wheels
in 5-parallel-spoke design (S design)
size 9 J x 20 with 265/40 R 20 tyres*



Forged aluminium wheels
in 5-spoke structured design, partly polished
size 9 J x 20 with 265/40 R 20 tyres*



Cast aluminium wheels
in 5-triple-spoke design (S design)
size 9 J x 21 with 265/35 R 21 tyres*

|Audi exclusive



Audi exclusive cast aluminium wheels
in 5-twin-spoke design
size 9 J x 19 with 255/45 R 19 tyres*
(also available with run-flat tyres).
From quattro GmbH



Audi exclusive cast aluminium wheels
in 7-twin-spoke design
size 9 J x 19 with 255/45 R 19 tyres*
(also available with run-flat tyres).
From quattro GmbH



Audi exclusive cast aluminium wheels
in 5-segment-spoke design
size 9 J x 20 with 265/40 R 20 tyres*.
From quattro GmbH



Audi exclusive forged aluminium wheels
in 7-twin-spoke design, polished, 2-tone
size 9 J x 20 with 265/40 R 20 tyres*.
From quattro GmbH



Audi exclusive forged aluminium wheels
in 7-twin-spoke design,
high-gloss polished finish, single-colour
size 9 J x 20 with 265/40 R 20 tyres*.
From quattro GmbH



Audi exclusive cast aluminium wheels
in 10-Y-spoke design
size 9 J x 20 with 265/40 R 20 tyres*.
From quattro GmbH



Audi exclusive cast aluminium wheels
in 5-arm structured design
size 9 J x 21 with 275/35 R 21 tyres*.
From quattro GmbH



Audi exclusive cast aluminium wheels
in 5-arm rotor design
size 9 J x 21 with 275/35 R 21 tyres*.
From quattro GmbH



Audi exclusive cast aluminium wheels
in 5-arm rotor design
matt titanium look, gloss turned finish
size 9 J x 21 with 275/35 R 21 tyres*.
From quattro GmbH

|Winter wheels



Cast aluminium winter wheels in 6-arm design
size 7.5 J x 17 with 235/60 R 17 tyres*,
permissible top speed 210 km/h,
can be fitted with snow chains



Cast aluminium winter wheels in 7-arm design
size 7.5 J x 18 with 235/55 R 18 tyres*,
permissible top speed 210 km/h,
can be fitted with snow chains



Cast aluminium winter wheels in 5-arm design
size 7.5 J x 19 with 235/50 R 19 tyres*,
permissible top speed 210 km/h,
can be fitted with snow chains,
(also available with run-flat tyres)



Cast aluminium winter wheels
in 5-parallel-spoke design (S design)
size 9 J x 20 with 265/40 R 20 tyres*,
permissible top speed 240 km/h,
cannot be fitted with snow chains



Forged aluminium winter wheels
in 10-parallel-spoke design
size 9 J x 20 with 265/40 R 20 tyres*,
permissible top speed 240 km/h,
cannot be fitted with snow chains

*You will find specifications on the technical characteristics of tyres on page 97.

The model-specific standard and optional equipment can be found in the index on page 100 onwards.



**You have to suffer a little,
to be this beautiful.**

When our experts test the quality of Audi wheels, they are just as innovative as our designers. Intense heat, high humidity, strong sunlight – the number of possible tests is almost limitless. The most extreme endurance test, however, is the copper accelerated salt spray test, or CASS for short. Here, wheels damaged by simulated stone impacts prior to the test are then sprayed with this extremely corrosive solution over a period of several days. They must withstand all these challenging conditions without any noticeable deterioration to ensure that, even after covering many kilometres, you remain just as delighted with the design of your Audi wheels as you were on the very first day.

Rest assured with premium quality.

As you take your seat in your Audi, you will appreciate just how special it is. The front and rear seats, with their high-quality materials and superb workmanship, exude a tangible sense of exclusive comfort. Regardless of which seat upholstery you choose, or whether you prefer the comfort seats or comfort sport seats for a dynamic driving style, rest assured that you have made the right choice.



Standard seats, front 1

Also available with memory function².
The image shows standard seat, front, in Valcona leather, velvet beige.

The model-specific standard and optional equipment can be found in the index from page 100 onwards.



Comfort seats, front 2

Comfort seats, front with seat ventilation 3

Both seat variants include a memory function².
Comfort seats, front, with seat ventilation and perforated leather.
The image shows comfort seat, front in Valcona leather, velvet beige, without seat ventilation.

¹In conjunction with memory function for standard seats, front. ²Further information on the memory function can be found on page 83 of this brochure.



Comfort sport seats, front 4

Comfort sport seats, front with seat ventilation 5

Both seat variants include a memory function² and feature perforated leather.
The image shows comfort sport seat, front in Valcona leather, velvet beige, with massage function.

| Cloth



Verdi cloth

| Valcona leather



1 Valcona leather, black



1 2 Valcona leather, nutmeg



2 Valcona leather, velvet beige 1 2



Valcona leather, black with round perforations 3



3 Valcona leather, nutmeg with round perforations 3



3 Valcona leather, velvet beige with round perforations 3



Valcona leather, black with square perforations and diamond-patterned stitching 4 5



Valcona leather, titanium grey 2



Valcona leather, velvet beige with square perforations and diamond-patterned stitching 4 5



Valcona leather, nougat brown 2



Valcona leather, titanium grey with round perforations 3



Valcona leather, Atlas beige 2



Valcona leather, nougat brown with round perforations 3



Valcona leather, titanium grey with square perforations and diamond-patterned stitching 4 5



Valcona leather, Atlas beige with round perforations 3



Valcona leather, nougat brown with square perforations and diamond-patterned stitching 4 5



Valcona leather, lunar silver/steel grey with square perforations and diamond-patterned stitching 4 5

| Valcona leather (design selection)



Valcona leather, Balao brown/snow white with round perforations 3



Valcona leather, Vermont brown/granite grey with square perforations and diamond-patterned stitching 5



Valcona leather, sycamore grey/brass gold with round perforations 3

| Natural leather



Natural leather, black with round perforations 3



Natural leather, nougat brown with round perforations 3



Natural leather, velvet beige with round perforations 3

Seats/seat upholstery Leather packages/headlining/Audi design selection Inlays

| Unicum leather



Unicum leather, nutmeg* with square perforations and diamond-patterned stitching 4 5

| Audi exclusive



Audi exclusive leather upholstery and trim 2 3 4 5 Individual choice of colour for leather/stitching/piping. From quattro GmbH. An extract from the range of Audi exclusive leathers can be found from page 64 onwards.

| Seat upholstery

Valcona leather

high-quality leather which contributes to the elegant charisma of the interior. The low use of lacquer allows the material to breathe whilst the non-grained surface underlines the sophisticated character. Tanned without the use of chromium, dyed through and treated with non-fading colour pigments

Natural leather

The natural characteristics of the leather and an excellent seating climate impart a luxurious character. Low use of lacquer and a non-grained surface. Over time, characteristic signs of use create a typical patina. Tanned without the use of chromium, dyed through and treated with non-fading colour pigments.

Unicum leather

Unicum leather is an exclusive natural leather. The leather is tanned using only plant extracts, is completely dyed through, is not coated with lacquer and yet is water- and dirt-repellent. The new combination of tanning agents creates a special microclimate that ensures exceptional moisture control. This method enables the natural characteristics of the leather to be shown off to their best advantage, the result being excellent breathability, softness and an incomparable natural feel. The typical natural features of the leather and any surface irregularities are also allowed to come through. A very special aura is created thanks to the agreeable feeling of warmth, the exquisite classic leather aroma and the natural feel of the material. Over time, characteristic signs of use create a typical patina.

| Seat variants

- 1 Standard seats, front
- 2 Comfort seats, front
- 3 Comfort seats, front with seat ventilation
- 4 Comfort sport seats, front
- 5 Comfort sport seats, front with seat ventilation

| Leather packages



Leather package
centre console including knee pad, door armrest upholstery and steering wheel airbag cover in leather with decorative stitching



Extended leather package
in addition to the contents of the leather package, includes: lower door trim including door pockets, underside of instrument panel including glove compartment, and MMI fascia in leather with decorative stitching



Full leather package
in addition to the contents of the extended leather package, includes: top side of instrument panel, door rails, front-seat trim and backrest covers, as well as head restraint linings front and rear in leather with decorative stitching; includes headlining and rear parcel shelf in Alcantara, as well as electric sunblinds for the rear window and the rear door windows

Audi exclusive leather upholstery and trim (package 1)¹
available in Valcona leather. Leather trim for: seats, centre armrest and door trim inserts. Individual choice of colour for the leather, decorative seams and piping from the Audi exclusive range of colours.

Audi exclusive leather upholstery and trim (package 2)¹
available in Valcona leather or Alcantara/Valcona leather. In addition to the contents of package 1, includes: centre console including knee pad, door armrest upholstery in leather. Seat centre panels and door trim inserts available in leather or Alcantara. Individual choice of colour for the leather, Alcantara, decorative stitching and piping from the Audi exclusive range of colours.

Audi exclusive leather upholstery and trim (package 3)¹
available in Valcona leather. In addition to the contents of package 2, includes: lower door trim including door pockets, underside of instrument panel including glove compartment and MMI fascia.

Audi exclusive leather upholstery and trim (package 4)¹
available in Valcona leather or Alcantara/Valcona leather. In addition to the contents of package 3, includes: top side of instrument panel, door rails, seat trim, head restraint linings front and rear and steering wheel including airbag cover and body in leather. Top side of instrument panel available in the following Audi exclusive leather colours: Havana brown, saddle brown, chestnut brown, crimson red, classic red, jet grey, smoky blue, night blue, Iceland green

| Headlining



Headlining and rear parcel shelf in Alcantara
in black, lunar silver, Atlas beige or silk beige to coordinate with the selected interior colour; headlining, upper pillar trim, sun visors and rear parcel shelf in Alcantara. Interior colours velvet beige and titanium grey come with matching rear parcel shelf.

Audi exclusive headlining in Alcantara¹
headlining, pillar trims, sun visors and headlining roof panel in Alcantara. Available in all Audi exclusive Alcantara colours. Grab handles, coat hooks and light unit are colour-coordinated.

Audi exclusive rear parcel shelf in Alcantara¹
available in all Audi exclusive Alcantara colours

| Audi design selection

Exclusive combination of refined interior colours, special materials and comfort-oriented equipment. The Audi design selections sycamore grey and Balao brown include the following:

- Metallic or pearl effect paint finish
- Comfort seats, front including Valcona leather
- Comfort centre armrest, front
- Seat heating, front and rear
- Seat ventilation and massage function, front
- Comfort head restraints, rear
- 4-zone deluxe automatic air conditioning²
- Ambient lighting
- Full leather package including headlining and rear parcel shelf in Alcantara as well as electric sunblinds on the rear window and on the rear door windows
- Lower inlay in brushed aluminium, silver
- Extended aluminium look in the interior
- “design selection” emblem in the door trims

The Audi design selection Vermont brown (exclusively for the S8) includes the following:

- Metallic or pearl effect paint finish
- Seat heating, front and rear
- Seat ventilation and massage function, front
- Comfort head restraints, rear
- 4-zone deluxe automatic air conditioning
- Full leather package including headlining and rear parcel shelf in Alcantara as well as electric sunblinds on the rear window and on the rear door windows
- “design selection” emblem in the door trims



Audi design selection sycamore grey
an exclusive combination of refined interior colours, special materials and comfort-oriented equipment:

- Comfort seats in Valcona leather, sycamore grey with accordion pleats, contrasting stitching and piping in brass gold
- Headlining, upper pillar trim and sun visors in Alcantara, snow white
- Rear parcel shelf in Alcantara, sycamore grey
- Top side of dashboard in marble grey with lock seams in sycamore grey or brass gold
- Multifunction leather steering wheel in 4-spoke design in marble grey with shift paddles
- Selector lever in leather, marble grey
- Bottom side of dashboard in sycamore grey
- Door armrest, centre console and knee pad in sycamore grey with contrasting stitching in brass gold
- Upper inlay in fine grain ash, natural pearl grey
- Centre console and wood trim on the back of the front seats in fine grain ash, natural pearl grey



Audi design selection Balao brown
an exclusive combination of refined interior colours, special materials and comfort-oriented equipment:

- Comfort seats in Valcona leather, Balao brown with accordion pleats, contrasting stitching and piping in snow white
- Headlining, upper pillar trim and sun visors in Alcantara, snow white
- Rear parcel shelf in Alcantara, Balao brown
- Top side of dashboard in mocca brown with lock seams in snow white or mocca brown
- Multifunction leather steering wheel in 4-spoke design in mocca brown with shift paddles
- Selector lever in leather, mocca brown
- Bottom side of dashboard in Balao brown
- Door armrest, centre console and knee pad in Balao brown with contrasting stitching in snow white
- Upper inlay in fine grain ash, natural balsamic brown
- Centre console and wood trim on the back of the front seats in fine grain ash, natural balsamic brown



Audi design selection Vermont brown
an exclusive combination of refined interior colours, special materials and comfort-oriented equipment:

- Comfort sport seats in Valcona leather, Vermont brown with accordion pleats, contrasting stitching and piping in granite grey
- Headlining, upper pillar trim and sun visors in Alcantara, lunar silver
- Rear parcel shelf in Alcantara, black
- Top side of dashboard in black with lock seams in black
- Multifunction sport leather steering wheel in 3-spoke design in black with S-specific contrasting stitching in Vermont brown, S8 emblem and aluminium-look shift paddles
- Selector lever in piano finish, black
- Bottom side of dashboard in black
- Door armrest, centre console and knee pad in black with contrasting stitching in Vermont brown
- Upper inlay in carbon twill, copper
- Centre console and wood trim on the back of the front seats in piano finish, black

Experience fascination. Down to the last detail.

Exclusive ambience is a question of style. Your style. A style you can refine right down to the last detail. Create tangible accents with high-quality Audi inlays. Enjoy the pleasure of smooth wood which radiates a natural warmth. Experience the fascination of open-pore wood whose exclusivity you can literally feel. Or make a personal statement with combinations of fine woods and aluminium trim - and allow your own personal taste to determine the character.



| Upper inlays



Walnut, dark brown
choice of lower inlay in high-gloss black or brushed aluminium, silver



Vavona, Assam grey
choice of lower inlay in high-gloss black or brushed aluminium, silver



Poplar, brown silver
choice of lower inlay in high-gloss black or brushed aluminium, silver



A fine finishing touch.

Not just any wood is allowed to adorn the interior of your Audi. The fine veneers for the inlays are stripped from the trunks and so-called root burls. Normally, a set of veneers for one car comes from just one burl or trunk to minimise variation. The production process utilises both state-of-the-art machines and the oldest tool in the world – the human hand, with some parts being crafted and polished manually to give them a unique feel.

Upper inlay
high-quality wood, piano finish, black, or carbon inlays add exclusive touches to the dashboard, door trim and centre console

Lower inlay
inlays in high-gloss black or brushed aluminium, silver on the dashboard and door trims create an impressive contrast

Audi exclusive inlays*
An extract from the range of Audi exclusive inlays can be found on page 65.



Grab handles with wooden segments
matched to the selected inlay; available for inlays in walnut, dark brown, vavona, Assam grey, poplar, brown silver and piano finish, black

Audi exclusive grab handles with wooden segments*
matched to the selected inlay



Upper inlay in walnut, dark brown
Lower inlay in brushed aluminium, silver
Aluminium look in the interior



Upper inlay in walnut, dark brown
Lower inlay in high-gloss black
Aluminium look in the interior

Aluminium look in the interior
aluminium-look elements on vent surrounds and thumbwheels, MMI display fascia, operating switch for electromechanical parking brake and console for window controls



Upper inlay in walnut, dark brown
Lower inlay in brushed aluminium, silver
Extended aluminium look in the interior



Upper inlay in walnut, dark brown
Lower inlay in high-gloss black
Extended aluminium look in the interior

Extended aluminium look in the interior
in addition to the aluminium look in the interior: aluminium-look elements on openers of the fold-open compartments in the door armrests and aluminium switches integrated into the lower inlay. Loading sill protector in stainless steel



Fine grain ash, natural brown gold
choice of lower inlay in high-gloss black or brushed aluminium, silver



Piano finish, black
choice of lower inlay in high-gloss black or brushed aluminium, silver



Carbon Atlas
choice of lower inlay in high-gloss black or brushed aluminium, silver



Carbon twill, copper
only available with lower inlay in brushed aluminium, silver



Fine grain ash, natural balsamic brown
only available with lower inlay in brushed aluminium, silver



Fine grain ash, natural pearl grey
only available with lower inlay in brushed aluminium, silver

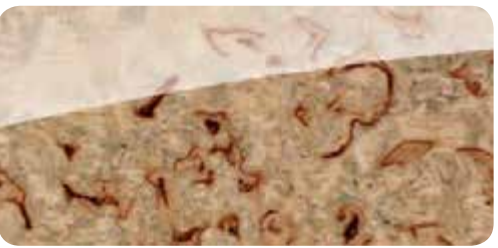

Fine grain birch, pearl beige
choice of lower inlay in high-gloss black or brushed aluminium, silver
From quattro GmbH



Fine grain ash, velvet brown
choice of lower inlay in high-gloss black or brushed aluminium, silver
From quattro GmbH



Audi exclusive inlays
From quattro GmbH.
An extract from the range of Audi exclusive inlays can be found on page 65.



High-gloss black



Brushed aluminium, silver

| Lower inlays

| Technology

tiptronic

8-speed automatic transmission with Dynamic Shift Program (DSP). Option of manual control via shift paddles on the multifunction leather steering wheel. Includes additional sport program

Start-stop system

helps to reduce fuel consumption and CO₂ emissions by switching off the engine automatically when the vehicle is stationary, e.g. at traffic lights. The start process is initiated as soon as the foot brake is released. Can be deactivated at any time via a button

Audi drive select

features different modes – comfort, dynamic, auto, efficiency (not on the A8 hybrid and A8 L hybrid) and individual – which allow you to change the vehicle's characteristics by adapting the power steering assistance, accelerator and gear changing characteristics, the adaptive air suspension and the settings of other optional equipment. The efficiency mode shifts the engine, transmission, climate control and optional adaptive cruise control or cruise control to a better basic setting.

Audi Space Frame (ASF®) body

The lightweight Audi Space Frame is an innovative combination of materials featuring a high degree of rigidity. This provides a high level of safety with an agile driving sensation – and reduced fuel consumption. The body is made almost entirely of aluminium. Because every gram less extends the lead. New, high-strength aluminium alloys are used for panels, castings and profiles and further reduce weight. For the first time, hot-formed steel panels are also integrated into the body structure in order to further improve its function. They are located in the region of the B-pillar.

adaptive air suspension

automatically regulates the vehicle height and damping by means of the electronically controlled air suspension with infinitely variable adaptive damping system on all 4 wheels. Includes ride height control and manual lift function; various modes can be selected via Audi drive select

adaptive air suspension sport

The sport suspension based on the standard adaptive air suspension has stiffer damping. Compared to adaptive air suspension, the vehicle ride height is lowered by up to 10 mm, depending on mode.

Electromechanical power steering

combines precision and comfort with exceptional energy-saving technology. The electromechanical steering system with speed-dependent steering assistance ensures stability at high speeds whilst also being light and extremely precise when parking and manoeuvring.

Dynamic steering

When changing lanes, parking and cornering, for example, this system improves handling and ride comfort by dynamically regulating the steering according to the driving situation. In addition to adaptation of the steering effort, the steering angle is also adapted (steering ratio). Also supports vehicle stabilisation through ESC.



quattro® with sport differential.

The electronically controlled sport differential distributes variable amounts of driving force to each rear wheel and ensures outstanding acceleration performance in corners and stabilises the vehicle's response to load change; it also improves direct steering characteristics and provides more agile handling due to the lower steering effort required.

quattro®

permanent all-wheel drive with self-locking centre differential and asymmetric/dynamic torque distribution, as well as wheel-selective torque control and Electronic Differential Lock (EDL) on all driven wheels

Active Noise Cancellation

can compensate noises from individual frequencies depending on the engine speeds



Ceramic brake

delivers impressive braking performance. 19-inch high-performance brake system with carbon-fibre reinforced ceramic brake discs¹ and brake callipers painted in high-gloss anthracite and featuring the "Audi ceramic" logo at front and rear. Ventilated and perforated brake discs with special cooling channels

Audi TDI clean diesel

In addition to the standard equipment with catalytic converter and diesel particulate filter, the exhaust aftertreatment system installed in the models with TDI clean diesel leads to low exhaust emissions and consequently complies with the EU6 emission standard which comes into force in September 2014. This technology significantly reduces nitrogen oxides by injecting small amounts of the biodegradable additive AdBlue®² into the exhaust flow. The nitrogen oxides are then split into nitrogen and water in the nitrogen-oxide catalytic converter (DeNOx catalytic converter). The separate AdBlue tank is refilled as indicated by the information in the display of the instrument cluster. We recommend having the AdBlue tank refilled at your Audi partner.

| Lights



Xenon plus

intensive illumination of the road, good uniformity and range, both close up and in the distance thanks to headlights utilising durable gas discharge technology for dipped and high beam. Automatic-dynamic headlight range control prevents oncoming traffic from being dazzled. LED daytime running light strip, all-weather light and headlight cleaning system are integrated into the system.



LED headlights

allow precise, near-daylight illumination of the road using LED technology. Combines dipped beam, high beam, daytime running lights, indicators and static turning light as well as an all-weather light to reduce the risk of the driver being dazzled when visibility is poor. Includes headlight cleaning system and high-beam assist. Striking light pattern in day and night design configurations; low energy consumption and long service life

Technology Lights Design Operation Comfort Transport Safety Assistance systems Infotainment Audi Extended Warranty



Audi Matrix LED headlights

This innovative technology combines a camera system with LED light sources and precision optics for highly adaptive light distribution. The system blanks out light that would otherwise shine directly on oncoming vehicles or vehicles in front but continues to fully illuminate all the other areas in between and alongside. The front lighting thus adapts dynamically, providing the driver with a much wider visual range. The conventional division between dipped and high beam is dispensed with. Familiar convenience functions such as the static turning light, all-weather light, junction light, motorway light and travel mode, which uses GPS data to switch between right- and left-hand drive modes are integrated into the LED technology. The LEDs of the Audi Matrix LED headlights also perform the cornering light functions. Using data from the navigation system for assistance, the cornering light function starts responding shortly before the steering wheel is turned. The marking light cooperates with the optional night vision assistant. If pedestrians are detected, individual LEDs flash briefly three times in succession to mark out the pedestrians clearly from their surroundings. Distinctive features include the crisp lighting pattern, the LED daytime running lights and the dynamic indicators in the headlights and rear lights.



LED rear lights

brake lights, tail lights and indicators, as well as rear number plate lights in LED technology; faster activation means earlier recognition by the driver behind. Also included are 2 rear fog lights, reversing lights in white and a 3rd high-mounted brake light in the rear window.

LED rear lights with dynamic indicators

same functions as the LED rear lights, but additionally feature a dynamic and quickly recognisable lighting pattern for the indicators. The segments of the LED light band are illuminated in turn within milliseconds, creating a pulse of light that runs outwards in the direction in which the car is turning. When operated, the indicators send a distinctive, innovative signal to other road users



Ambient lighting

anti-glare background lighting for the passenger compartment in LED technology. Consisting of a light band in roof module and light bands at the sides. Lighting for door pockets, footwells, inside door handles and door sill trims. Surround lighting for centre console (floating effect). Brightness can be adjusted in 4 zones, each with 20 dimming stages. A choice of 3 colour moods can be selected in the MMI

Interior and exterior lighting package

interior lighting with glove compartment lighting. Reading lights in the roof module, footwell lighting front/rear, door trim lighting, vanity lights, light bands at the sides, side-mounted reading lights in the rear and luggage compartment lighting in LED technology. Exterior lighting with courtesy lighting on the underside of the door handles and handle recess lighting in LED technology

¹ Please consult your Audi partner or national Audi website to find out more about the special features of the ceramic brake.

² Registered trademark of the Verband der Automobilindustrie e.V. (VDA).

| Design



Door sill trims with aluminium inlay illuminated in combination with ambient lighting; with model-specific illuminated logo on the A8 hybrid, A8 L hybrid, A8 L W12 and S8



Audi exclusive front and rear personalised door sill trims*

The aluminium inlay on the front and rear door sill trims can be personalised with a logo.

| Operation



Convenience key including sensor-controlled release of the luggage compartment lid

Doors and luggage compartment lid can be opened and locked without actuating the key carried with you. Touching the door handles or handle strip on the luggage compartment lid respectively unlocks the doors and luggage compartment automatically. Moving your foot (in a kicking motion) below the rear bumper causes the luggage compartment lid to swing open automatically. The luggage compartment lid can also be opened when the vehicle is locked.

Remote control key

unlocks and locks doors, luggage compartment lid and tank flap. Includes keyless go and convenience closing/opening of the windows

Power-assisted closing for the doors

Doors that have not completely closed are pulled into the lock automatically. Electric child-proof locks on the rear doors, operated via the child-proof lock buttons in the driver's door armrest

Luggage compartment lid with electric opening and closing function

opening via button on the vehicle key or in the driver's door or via the soft touch button in the luggage compartment lid handle. Additionally by means of foot gesture (kicking motion) if convenience key including sensor-controlled release of luggage compartment lid is ordered. Closing via button on the inside of luggage compartment lid, the button in the driver's door or the convenience key (long press). In conjunction with the convenience key, it is possible to close the luggage compartment lid and simultaneously lock the car via an additional button on the inside of the luggage compartment lid.

Garage door opener (HomeLink)

programmable radio-operated remote control with operating buttons integrated into the front roof module, can be used to open many garage doors and exterior gates. Allows control of security systems and lighting systems. Code identification guidance and set-up assistance provided by the MMI. (Please contact your Audi partner or visit www.eurohomelink.com for further information).



Multifunction leather steering wheel in 4-spoke design with shift paddles

for operation of installed infotainment equipment. Shift paddles for manual gear changing. With full-size airbag and selector lever knob in leather, colour-coordinated with the selected colour for the top side of the dashboard

Multifunction leather steering wheel in 4-spoke design with shift paddles, heated

same functions as the multifunction sport leather steering wheel in 4-spoke design with shift paddles, but additionally heated; colour-coordinated with the selected colour for the top side of the dashboard



Multifunction sport leather steering wheel in 3-spoke design with shift paddles

for operation of installed infotainment equipment. Shift paddles for manual gear changing. With full-size airbag and selector lever knob in leather, colour-coordinated with the selected colour for the top side of the dashboard

Multifunction sport leather steering wheel in 3-spoke design with shift paddles, heated

same functions as the multifunction sport leather steering wheel in 3-spoke design with shift paddles, but additionally heated; colour-coordinated with the selected colour for the top side of the dashboard



Steering wheel rim with wooden segments*

for multifunction steering wheel in 4-spoke design with shift paddles. Available in walnut, dark brown, vavona, Assam grey, fine grain ash, velvet brown as well as fine grain birch, pearl beige

Audi exclusive steering wheel rim with wooden segments*

customised with Audi exclusive wood and leather. Stitching on the steering wheel rim with specific Audi exclusive seam detail. Available as multifunction leather steering wheel in 4-spoke design with shift paddles

Audi exclusive leather steering wheel*

leather covering of the steering wheel rim and the airbag cover. Individual choice of colour for leather and stitching in all Audi exclusive colours. Stitching on the steering wheel rim with specific Audi exclusive seam detail

Audi exclusive leather controls*

leather covering of the steering wheel rim, selector lever and the airbag cover in a range of Audi exclusive colours. Individual choice of Audi exclusive colour for stitching. Stitching on the steering wheel rim with specific Audi exclusive seam detail.



Selector lever in leather

colour-coordinated with the selected vehicle interior colour and to match the top side of the dashboard. With shift-by-wire technology



Selector lever in wood

matched to the selected inlay. With shift-by-wire technology



Audi exclusive selector lever in wood*

available in a choice of 6 different Audi exclusive woods (not available in tamo ash, natural dark brown). With shift-by-wire technology



Selector lever in carbon Atlas

with shift-by-wire technology

| Comfort

**Panoramic glass sunroof**

2 sections, electric activation to raise and open the front glass section as well as to raise the rear glass section, opens and closes automatically. With tinted glass insert and 2 electrically operated sunblinds as well as convenience closing via the remote control key. Ensures that the interior is flooded with light. Good acoustics and low wind noise when the sunroof is extended or fully opened. Improves the interior climate by means of efficient ventilation whilst at the same time reducing draughts. Vanity mirrors and additional reading lights in the rear. With selected exterior colours¹, the surrounding roof is painted in black.

**Slide-and-tilt glass sunroof**

electric, with tinted single-glazed safety glass and infinitely adjustable sun shield. Wind deflector extends automatically in stages depending on roof opening and speed. Convenience closing from outside via the central locking system and the remote control key

**Solar slide-and-tilt glass sunroof**

solar cells in the roof provide the power to generate a continuous flow of air to reduce passenger compartment temperature when the vehicle is parked. Operated like the slide-and-tilt glass sunroof, but has no infinitely adjustable sun shield

**Sunblinds**

protect the passengers in the back from direct sunlight

optionally:

electrically operated for the rear window

electrically operated for the rear window and rear door windows

Double/acoustic glazing

provides improved exterior noise insulation and theft protection thanks to the 2 panes of glass bonded together by a plastic film

Insulating/acoustic glass

provides improved exterior noise insulation and theft protection thanks to the 2 panes of glass bonded together by a plastic film. An additional reflective coating reduces the build-up of heat in the interior. Viewing window for automatic toll collection devices in the upper right-hand corner, to the side of the interior mirror

Insulating/acoustic glass with windscreen heater

Full surface of windscreen heated without heating wires that might impair visibility, makes rapid defrosting easier and ensures that the windscreen stays mist free. Heating controlled via the deluxe automatic air conditioning

**Dark-tinted windows (privacy glazing)**

dark-tinted rear window, rear door windows and rear side windows. Optionally with windscreen heater

**Comfort centre armrest, front**

with fold-open storage compartments; divided for driver and front passenger. Infinite vertical/horizontal adjustment

Seat heating, front

heats the seat and backrest centre panels, seat and backrest side bolsters, as well as thigh support for the driver and front-passenger seats. Can be individually adjusted in 3 stages via a direct selection button on the air conditioning controls

Seat heating, front and rear

same functions as seat heating, front. For the outer rear seats, can be regulated separately

Seat ventilation, front

By drawing in air, the system ensures a pleasant seating climate can be enjoyed even in high temperatures. Seat ventilation for the seat and backrest centre panels, the seat and backrest side bolsters as well as thigh support for the driver and front-passenger seats (can be adjusted in 3 stages)

Seat ventilation, front and rear

functions same as for seat ventilation, front plus ventilation for the outer rear seats.

**Comfort head restraints, rear**

Manually adjustable side bolsters provide enhanced comfort and good lateral support

Massage function, front

massages the muscles of the driver and front passenger using 10 pneumatic cushions. 5 different programs (Wave, Tapping, Stretch, Lumbar, Shoulder) can be selected via multifunction switches on the seat. Display in MMI

Massage function, front and rear

same functions as massage function for the front seat plus, for the outer rear seats, a choice of 2 different programs (Wave, Tapping) each offering 3 levels of intensity. Can be selected from the centre armrest in the rear

Memory function for standard seats, front

memory function for driver and front-passenger seat, steering wheel, both exterior mirrors, head restraint height and seat belt height at front; includes electric adjustment of the front head restraint and belt height

**Audi exclusive folding table²**

with fine wood inlay, on the back of the driver's and/or front-passenger seat backrest. Operated manually

**230V/115V/100V socket**

for direct operation of electrical consumers such as power adapters for laptops, mobile phones, games consoles or other AC equipment with a power output of up to 150 watts. Works when the ignition is switched on. Replaces the 12V socket/cigarette lighter in rear

Audi exclusive personalisation of the folding table²

customisation of the fine wood folding table with lettering, a logo or a coat of arms. The feature is visible when the table is closed and folded away.

Audi exclusive storage compartment²

additional lockable storage compartment. Integrated into the full-length centre console

Footrests, rear

for comfortable travel in the rear. Available in pairs

Audi exclusive rear foot rests²

colour-coordinated with the Audi exclusive carpet

Audi exclusive floor mats²

individual choice of colour for the floor mats, the leather piping and the stitching from the range of Audi exclusive colours

Audi exclusive carpet and floor mats²

individual choice of colour for the floor mats, the leather piping, the stitching and the carpet from the range of Audi exclusive colours

Cigarette lighter and ashtray

illuminated, front and rear

Non-smoker package

12V socket in the centre console, front and rear, to replace the cigarette lighter

ISOFIX child seat mounting and Top Tether for the outer rear seats

standard bracket for the practical fastening of ISOFIX child seats. Including additional attachment point (Top Tether). Recommended child seats can be obtained from your Audi partner.

| Comfort

**Rear seat system**

3 seats, with fold-out centre armrest including 2 cup holders and one storage compartment. (The image shows rear seat system in conjunction with comfort seats, front.)

Rear seat package in sport seat look¹

electrically adjustable rear bench seat combined with comfort sport seat look

**Individual seat package, rear with full-length leather-covered centre console**

2 individual seats in rear, electrically adjustable; includes the following features in addition to the contents of the individual seat package, rear:

- full length leather-covered centre console with armrest, wood trim, controls and 230 V socket, leather package and ambient lighting
- seat ventilation and massage function, front and rear
- additional storage possibilities in the centre console

(The image shows individual seat package, rear with full length leather-covered centre console in conjunction with comfort sport seats, front and Audi exclusive leather upholstery and trim (see page 62 onwards) as well as the optional Rear Seat Entertainment)

**Additional reading lights in the rear**

2 additional LED reading lights integrated into the vehicle headlining

**Audi exclusive cardan reading lights in the rear¹**

2 additional swivelling reading lights with LED technology, integrated into the vehicle headlining. Cone of light from reading lamps can be manually adjusted

**3-zone deluxe automatic air conditioning**

Same as deluxe automatic air conditioning but with the following additional features: air conditioning controls for rear compartment climate control in the rear centre armrest with separately adjustable temperature and blower settings and air distribution. Functions for rear compartment can also be controlled from the front air conditioning controls

**Auxiliary heating/ventilation**

The auxiliary heating warms up the interior and removes ice from the windows without starting the engine. The auxiliary ventilation system supplies fresh air and reduces the temperature of the interior. Intelligent control function with timer and departure time programming for time- and energy-efficient calculation of heating duration. Separate radio-operated remote control with illuminated display

**Individual seat package, rear**

- 3-seater rear seat system with 2 electrically adjustable individual seats
 - adjustment of fore/aft position, seat and upper backrest angle
 - pneumatic lumbar support
 - memory function for the individual seats
 - comfort head restraints, rear
 - 4-zone deluxe automatic air conditioning²
 - comfort centre armrest, rear, with wood or carbon trim and controls
 - electric sunblinds for the rear window and rear door windows
 - fore/aft position of front-passenger seat electrically adjustable from the rear
- (The image shows individual seat package, rear in conjunction with comfort seats, front.)

The model-specific standard and optional equipment can be found in the index from page 100 onwards.

**Relaxation seat package, rear with full-length leather-covered centre console**

2 individual seats in rear, electrically adjustable; Same as the individual seat package, rear with full-length leather-covered centre console but with the following additional features:

- luxurious relaxation seat behind the front-passenger seat with footrest on the back of the front-passenger seat backrest
- pneumatic massage as well as seat ventilation and seat heating front and rear
- extending table in the centre console
- Rear Seat Entertainment

(The image shows the relaxation seat package, rear with full-length leather-covered centre console in conjunction with comfort seats, front.)

Please note: front-passenger seat available only with restricted functions: without adjustable upper backrest, head restraint height, lumbar support, seat and backrest side bolsters; seat ventilation only for the seat cushion, massage function not available

**Vanity mirrors and additional reading lights in the rear**

2 additional LED reading lights integrated into the vehicle headlining and 2 illuminated vanity mirrors

**Deluxe automatic air conditioning**

separate temperature and air flow control for head area and footwell for both driver and front passenger, with indirect ventilation and sunlight-dependent control. Air intake control and recirculation mode, residual heat utilisation, combined/fine particulate filter, air quality and humidity sensor and key-coded setting. Choice of 3 climates: gentle, medium and intensive

**4-zone deluxe automatic air conditioning**

greater comfort for the rear passengers and enhanced heating and cooling performance through the use of a 2nd air-conditioning unit. Same as deluxe automatic air conditioning but with the following additional features: air conditioning controls for rear compartment climate control in the rear centre armrest with separately adjustable temperature and blower settings and air distribution for the right- and left-hand sides

Ioniser

can help to improve wellbeing and attentiveness. Ionisation reduces harmful particles and germs in the air, thus improving the air quality in the vehicle interior. Activation by means of a button on the right-hand B-pillar

¹From quattro GmbH. ²3-zone deluxe automatic air conditioning on A8 hybrid and A8 L hybrid.

| Comfort



Audi exclusive bar compartment¹
additional storage compartment for 2 glasses.
Integrated into the full-length centre console



Audi exclusive coolbox¹
storage compartment for two 1 litre bottles lying down.
Additional storage compartment for cans and glasses.
With compressor cooling technology and 2 possible
temperature settings: -6°C freeze, +6°C cool. Interior
LED lighting

| Transport



A8 hybrid luggage set
customised for the A8 hybrid and A8 L hybrid luggage
compartment. Set comprises 2 suitcase trolleys
(each 63 l) and 2 cabin trolleys (each 40 l) featuring
polycarbonate shells with nylon fabric and telescopic
handles, smooth running wheels, and handle application
made of cowhide; 1 shoe bag (20 l) made from grey
nylon fabric for holding up to 2 pairs of shoes

Trailer towing hitch

electrically swivelling, ball head and ball bar made
from special steel. Operated via button in luggage
compartment. Trailer stabilisation system via
Electronic Stabilisation Control (ESC). The integrated
swivelling system socket enables continuous operation
of electrical equipment in the trailer or caravan during
a journey.

Luggage compartment package

for flexibility when transporting objects and comfort
on journeys. Comprises a luggage net for securing
to the lashing points in the luggage compartment,
2 fold-out bag hooks integrated into the top of the
luggage compartment, a 12V socket on the side wall
and an umbrella holder on the inside of the luggage
compartment lid



Through-loading facility
enables extended loading possibility for the practical
transportation of long objects

**Through-loading facility with removable ski/snowboard bag**

for the practical transportation of long objects,
e. g. up to 2 pairs of skis or 1 snowboard

Technology Lights Design Operation Comfort Transport Safety Assistance systems Infotainment Audi Extended Warranty

| Safety

Audi exclusive seat belts¹
available in all Audi exclusive colours. To match the
Audi exclusive leather range of colours

Anti-theft alarm

monitors doors, bonnet and luggage compartment lid
as well as the interior. Automatically activated by the
vehicle key. Includes electronic immobiliser, ultrasonic
interior monitoring (can be deactivated) and signal
horn independent of the vehicle electrical system.
With tow-away protection via a vehicle angle of
inclination sensor (can be deactivated)

| Assistance systems

Cruise control
maintains any set speed between around 30 km/h and
250 km/h, provided that engine power and engine
braking effect permit it. Automatic braking intervention,
e.g. when driving downhill. Operated via separate
steering column stalk. Set speed displayed in the
driver information system

Secondary collision brake assist

Following an accident, uncontrolled continued vehicle
motion is prevented in certain situations. In these
cases secondary collisions can be avoided.

Audi pre sense basic

initiates preventive passenger protection measures
when required. These include: belt tensioning,
activation of the hazard warning lights and closing of
sunroof and windows. Categorises different driving
situations through the networking of the various
vehicle systems

**adaptive cruise control with Stop&Go function including Audi pre sense front²**

detects vehicles ahead with the aid of radar sensors.
The distance from the vehicle ahead is kept more or
less constant by braking or accelerating (control range
0-250 km/h). Braking to a stop and automatic restart
at driver's request are possible. 4 distance levels/
driving modes (efficiency, comfort, dynamic and auto)
can be selected.



Audi side assist including Audi pre sense rear²
emits a warning in the form of a display in the
respective exterior mirror if a situation arises which
the system deems will compromise a lane change.
2 radar sensors record the vehicle approaching from
behind and measure the distance and the difference
in speed. The lane change assistant provides support
in the speed range from 30 to 250 km/h. To detect a
possible rear-end collision, Audi pre sense rear also
uses the rear sensors of Audi side assist, in addition to
Audi pre sense basic.

**Audi active lane assist²**

helps to keep you in lane by applying gentle corrective
steering movements. Working within system limits,
Audi lane assist is activated if the car starts to cross
detected road markings and the driver has not
operated an indicator. The system provides assistance
between speeds of 60 and 250 km/h. Steering wheel
vibration can be adjusted to the driver's wishes.

¹ From quattro GmbH. ² Please note: the systems only work within system limits. They assist the driver with driving tasks. However, the driver remains responsible for driving the vehicle and is required to be attentive.

| Assistance systems

**Head-up display**

Information relevant to the driver from assistance systems, navigation instructions and warnings is projected as required onto the windscreen in the driver's direct field of vision. The height-adjustable head-up display provides a multicoloured display with good contrast and minimal distraction from the road.

**Camera-based speed limit display**

recognition and display of speed limits, including temporary speed limit displays. A situational evaluation is carried out when driving in the wet, when there are speed limits for certain times of the day, or when towing a trailer. If a sign has not been recognised by the camera, the speed limit taken from the current navigation data is displayed via Audi connect

**Park assist with display of surroundings**

helps you move into and out of parking spaces by performing autonomous steering manoeuvres. Calculates the ideal parking path for bay parking spaces and the ideal parking and exiting paths for kerb-side parking spaces. The driver has to accelerate, apply the brakes and monitor the parking process. The display of the surroundings warns the driver of any obstacles at the side of the vehicle, depending on the steering angle. Also additionally available with reversing camera or 360 degree cameras

**360 degree cameras**

safe pulling out of narrow parking spaces. Various display options for the area around the vehicle, including a virtual top view, can be selected on the MMI display. The driver can select between different image views in the MMI display: reversing image, front camera image, front and rear side view as well as bird's eye view. Includes the features of the reversing camera

| Infotainment

**Driver information system with colour display**

displays a host of information on a high-resolution 7-inch colour display in the instrument cluster. Attention assist warns the driver, in the form of an acoustic signal and a visual warning, if it has evaluated that the driver's attention is lapsing. Includes integrated efficiency program. A8 hybrid and A8 L hybrid models have an additional display of the flow of energy

**MMI® navigation plus with MMI touch**

hard disc navigation with topographical map display and display of sightseeing information and city models in 3D². Dynamic route guidance with TMCpro, vehicle support based on navigation data and speed limit display. Intuitive operation via MMI touch with handwriting recognition for entry of letters and numbers; can be controlled without the need for drivers to divert their eyes from the road. Voice control system enables operation by means of whole-word entry of address in one sentence. Includes Bluetooth interface, 20 GB music storage and Audi music interface. In conjunction with Audi connect including car phone, it is possible to use various services supported by Audi connect³. The display in A8 hybrid and A8 L hybrid models features an additional display of the energy flow and the consumption diagram

**Audi connect including car phone**

use of Audi connect and convenient telephone operation thanks to integrated car phone. Vehicle is connected to the internet via an integrated data module. Requires a Bluetooth-capable mobile phone⁴ (with SIM Access Profile) to be connected or a SIM card to be inserted. Possible to transfer phone book entries and manage call lists

**Night vision assistant¹**

assists the driver when driving at night by displaying a thermal image of the surroundings. Persons and larger wild animals are highlighted in yellow in the driver information system. If they move or if the system determines from their position that there is a potential risk, the marking changes to red, a warning triangle appears and a warning tone is emitted.

**Parking system plus**

acoustic and visual parking system for the front and rear shown on the MMI display. Measurement by ultrasonic sensors concealed in the bumpers

**Reversing camera**

image of area behind the vehicle shown on the MMI display, with dynamic display modes showing the calculated path (steering angle dependent). Auxiliary lines and guidelines and identification of the point at which to apply opposite lock when parallel parking. Reversing camera integrated discreetly in the luggage compartment lid handle strip

Assistance package including Audi pre sense plus¹

The assistance package combines the functions of adaptive cruise control with Stop&Go function, Audi side assist, Audi active lane assist, parking system plus, Audi pre sense front and Audi pre sense rear. Also includes a maximum deceleration function provided by Audi pre sense plus. The systems in the assistance package complement each other and provide mutual assistance.

MMI®

integrated operating concept consisting of MMI terminal as the control unit and MMI display for showing various menus. The high-resolution 8-inch colour display in high-quality piano finish look is retractable. 6 freely programmable radio station presets enable fast retrieval

MMI® touch

context-related entry of letters, characters and numbers on touch-sensitive control panel with handwriting recognition for intuitive operation of the MMI. Selection from address book and entry of navigation destinations or phone numbers with acoustic acknowledgement allow drivers to keep their eyes on the road. Simple movement of navigation map

¹ Please note: the systems only work within system limits. They assist the driver with driving tasks. The driver remains responsible for driving the vehicle and is required to be attentive. ² The navigation data for several countries is stored on the hard disc. ³ Requires the optional Audi connect including car phone. ⁴ For information on adapters and compatible mobile phones, please contact your Audi partner or visit www.audi.com/bluetooth.

| Infotainment



MMI® radio plus

can be operated via MMI and the multifunction leather steering wheel. Equipped with triple tuner with phase diversity for improved sound and reception. Dynamic station list and TP memo function whilst driving. Music and videos can be played via the single DVD drive, the 2 SDHC memory card readers and the jukebox with 20 GB storage capacity

Digital Audio Broadcasting

programmes from digitally broadcast radio stations² can be received for better sound quality to DAB standards; includes DAB+ and DMB audio. Display of additional information accompanying the programme (e.g. artist, track and cover) in the form of a slide show and other programme-independent data services (e.g. weather, traffic and news)

Digital TV reception

reception of digitally broadcast (DVB-T), uncoded television stations² (MPEG-2 or MPEG-4 standard), DVB-T audio stations, teletext and Electronic Programme Guide (EPG). External AV-IN connection via adapter cable (available through Audi Genuine Accessories). No picture possible when the vehicle is moving

Audi music interface

enables the use of portable media players³, such as an Apple iPod, Apple iPhone (music functionality) and USB storage media and MP3 players, by means of special adapter cables from Audi Genuine Accessories. Located in the centre console. Operated via MMI or a multifunction leather steering wheel. Part of MMI navigation plus with MMI touch

Preparation for mobile phone (Bluetooth)

connection of compatible mobile phones to the external aerial via the base plate and adapter. Operation via MMI, multifunction leather steering wheel or voice control system. Comprises a hands-free facility with voice control for telephone functions and a preparation for a mobile phone-specific charger from Audi Genuine Accessories

The model-specific standard and optional equipment can be found in the index from page 100 onwards.



Audi sound system

6-channel amplifier with a total output of 180 watts and 10 loudspeakers, including centre speaker in the dashboard and subwoofer in the rear parcel shelf



Bose surround sound

impressive surround sound reproduction thanks to 12-channel amplifier with total output of over 600 watts and 14 loudspeakers, including centre speaker and subwoofer. AudioPilot® for noise-dependent volume adjustment. 5.1 surround sound reproduction. Powerful and accurate bass reproduction thanks to Acoustic Wave loudspeaker technology



Bang & Olufsen Advanced Sound System

captivating surround sound reproduction with 19 loudspeakers, including subwoofer, each with its own amplifier channel. The highly efficient all-digital 5-channel ICE Power amplifier for woofer and subwoofer and the 14-channel DSP all-digital amplifier have a total output of over 1,400 watts and are capable of reproducing 5.1 Surround Sound. Polished loudspeaker covers in aluminium and automatically extending acoustic lenses for excellent sound performance and perspective in any seat. Noise-dependent volume adjustment. Privacy function provided by encapsulated loudspeaker casings which minimise the escape of sound to the outside of the vehicle and provide privacy, for example when making telephone calls.

DVD/CD changer

supports e.g. audio CDs, video DVDs, MP3, WMA, AAC, MPEG-4 and playlists as well as up to 4,000 tracks per medium. 6 DVDs or CDs can be changed individually. Files with digital rights management (DRM) cannot be played. Shock-resistant location in glove compartment. Can be operated via MMI or multifunction leather steering wheel



Rear Seat Entertainment

superb entertainment facility for the rear passengers, with 2 high-resolution adjustable-angle 10.2-inch LCD displays. Access to numerous audio and video sources. Use of navigation functions. Shared or separate video and audio playback for each seat. Sound output via the vehicle sound system or separate headphones. Includes Audi music interface and MMI control panel in rear

| Audi Extended Warranty

Audi Extended Warranty

The Audi Extended Warranty provides extended risk cover and cost control beyond the first 2 years of the manufacturer's warranty for a variety of claims. It can be ordered directly and only on purchase of a new car. 9 combinations of service life and mileage can be selected. For more information, please contact your Audi partner.

¹Please contact your Audi partner or visit www.audi.com/bluetooth for information on adapters and compatible mobile phones. ²Reception depends on local digital network availability.

³Please contact your Audi partner or visit www.audi.com/mp3 for information on compatible media players.

Audi Genuine Accessories. As individual as the life you lead.

An Audi is an expression of your personality. And Audi Genuine Accessories build on this concept in the truest sense of the word, with a range of high-quality products that are coordinated with your Audi. Noted for their perfect fit, safety credentials and functionality, they serve to add even more individuality to your car and to tailor it to your own personal requirements. So that your Audi becomes your own personal Audi. These two pages contain just a small selection from the extensive range of Audi Genuine Accessories on offer.



Detailed information can be obtained from the Audi A8 accessories catalogue, at www.audi.com, and from your Audi partner.

Cast aluminium wheels in 5-arm parabola design

Exceptional design, perfectly matched to your Audi A8. With arms in a gloss turned finish, size 9 J x 20. For 265/40 R 20 tyres*.



Carrier unit with ski and luggage box (480 l)

Carrier unit for various roof rack modules such as the ski and luggage box. The profile section of the carrier unit is made from anodised aluminium. The carrier unit is easy to install and is lockable. The ski and luggage box for winter sports equipment and other luggage is also lockable, can be opened from both sides and has a volume of 480 litres. Easy to clean thanks to smooth surface.

Navigation update

Map data containing upgraded contents, e.g. new roads, points of interest and restaurants. For added convenience and a more relaxed driving experience. We recommend that you combine the update with your next vehicle service. For more detailed information, please contact your Audi partner.

Audi child seat youngster plus.

Offers superior comfort thanks to intelligent belt guidance. The backrest is adjustable in height and width. Adaptations can be made via a viewing window for size adjustment. Cloth cover can be removed and washed, is breathable and gentle on the skin, certified in accordance with Oeko-Tex® standard 100, in the colours Misano red/black and titanium grey/black. Suitable for children from 15 to 36 kg (approximately 4 to 12 years).



Universal mobile telephone holder

Allows low-radiation phone calls through connection to the external aerial and stores the mobile phone safely while driving. The mobile phone is placed conveniently into the universal holder and wirelessly connects with the external aerial of the vehicle. Works with popular mobile phone models, so there is no need to change adapters when you switch mobile phones. Required: preparation for mobile phone (Bluetooth). The USB charging adapters, available separately for many popular mobile phone models, enable easy charging of your mobile phone's battery.

Audi Tracking Assistant plus

Enables a stolen vehicle to be located and tracked via GPS/GSM technology in 27 European countries. With automatic driver recognition and intelligent restart inhibitor. For more detailed information, please contact your Audi partner.

*You will find specifications on the technical characteristics of tyres on page 97.

The fuel consumption and CO₂ emission figures as well as the efficiency classes can be found from page 94 onwards.

Model	A8 3.0 TFSI quattro (228 kW)		A8 4.0 TFSI quattro (320 kW)		A8 3.0 TDI clean diesel quattro (190 kW) ¹¹		A8 4.2 TDI clean diesel quattro (283 kW) ¹¹		
Engine type	V6 petrol engine with direct fuel injection and mechanical supercharger module		V8 bi-turbo petrol engine with direct fuel injection, Audi valvelift system and Audi cylinder on demand		V6 diesel engine with common rail injection system and turbocharging		V8 diesel engine with common rail injection system and turbocharging		
Displacement in cc (valves per cylinder)	2,995 (4)		3,993 (4)		2,967 (4)		4,134 (4)		
Max. output ¹ in kW at rpm	228/5,200–6,500		320/5,100–6,000		190/4,000–4,250		283/3,750		
Max. torque in Nm at rpm	440/2,900–4,750		600/1,500–5,000		580/1,750–2,500		850/2,000–2,750		
Power transmission/wheels									
Drive type	quattro® permanent all-wheel drive		quattro® permanent all-wheel drive		quattro® permanent all-wheel drive		quattro® permanent all-wheel drive		
Transmission type	8-speed tiptronic		8-speed tiptronic		8-speed tiptronic		8-speed tiptronic		
Wheels	Forged aluminium wheels, 8 J x 17		Cast aluminium wheels, 8 J x 18		Forged aluminium wheels, 8 J x 17		Cast aluminium wheels, 8 J x 18		
Tyres	235/60 R 17 ²		235/55 R 18 ²		235/60 R 17 ²		235/55 R 18 ²		
Weights/capacities									
	A8	A8 L	A8	A8 L	A8	A8 L	A8	A8 L	
Unladen weight ³ in kg	1,905	1,955	1,995	2,050	1,955	2,010	2,115	2,170	
Gross vehicle weight in kg	2,520	2,530	2,570	2,625	2,570	2,585	2,705	2,720	
Roof load/trailer nose weight in kg	100/95	100/95	100/95	100/95	100/95	100/95	100/95	100/95	
Trailer load limit ⁴ in kg	unbraked	750	750	750	750	750	750	750	
	12 % gradient	2,300	2,300	2,300	2,300	2,200	2,300	2,300	
	8 % gradient	2,300	2,300	2,300	2,300	2,200	2,300	2,300	
Fuel tank capacity, approx. in l	82	82	82	82	82	82	82	82	
Performance/consumption⁵									
Top speed in km/h	250 ⁶	250 ⁶	250 ⁶	250 ⁶	250 ⁶	250 ⁶	250 ⁶	250 ⁶	
Acceleration 0–100 km/h in s	5.7	5.9	4.5	4.6	5.9	6.1	4.7	4.9	
Fuel grade	Sulphur-free super RON 95 ⁷		Sulphur-free super plus RON 98 ⁸		Sulphur-free diesel ⁹		Sulphur-free diesel ⁹		
Fuel consumption ¹⁰ in l/100 km	urban	10.5	10.6	12.6	12.8	7.3	7.5	9.4	9.5
	extra-urban	6.3	6.3	7.1	7.2	5.1	5.2	6.1	6.2
	combined	7.8	7.9	9.1	9.2	5.9	6.0	7.4	7.5
CO ₂ emissions ¹⁰ in g/km	urban	245	246	294	299	192	196	247	249
	extra-urban	147	148	166	169	134	136	161	163
	combined	183	184	213	216	155	158	194	197
Efficiency class/emission standard	C/EU6	C/EU6	D/EU6	D/EU6	B/EU6	B/EU6	C/EU6	C/EU6	

Model	A8 L W12 6.3 FSI quattro (368 kW)		S8 4.0 TFSI quattro (382 kW)	
Engine type	W12 petrol engine with direct fuel injection and Audi cylinder on demand		V8 bi-turbo petrol engine with direct fuel injection, Audi valvelift system and Audi cylinder on demand	
Displacement in cc (valves per cylinder)	6,299 (4)		3,993 (4)	
Max. output ¹ in kW at rpm	368/6,200		382/5,800	
Max. torque in Nm at rpm	625/4,750		650/1,700–5,500	
Power transmission/wheels				
Drive type	quattro® permanent all-wheel drive		quattro® permanent all-wheel drive	
Transmission type	8-speed tiptronic		8-speed tiptronic	
Wheels	Cast aluminium wheels, 9 J x 19		Cast aluminium wheels, 9 J x 20	
Tyres	255/45 R 19 ²		265/40 R 20 ²	
Weights/capacities				
Unladen weight ³ in kg	2,150		2,065	
Gross vehicle weight in kg	2,675		2,590	
Roof load/trailer nose weight in kg	100/95		100/95	
Trailer load limit ⁴ in kg	unbraked	750	750	
	12 % gradient	2,300	2,300	
	8 % gradient	2,300	2,300	
Fuel tank capacity, approx. in l	82		82	
Performance/consumption⁵				
Top speed in km/h	250 ⁶		250 ⁶	
Acceleration 0–100 km/h in s	4.6		4.1	
Fuel grade	Sulphur-free super RON 95 ⁷		Sulphur-free super plus RON 98 ⁸	
Fuel consumption ¹⁰ in l/100 km	urban	15.7	13.6	
	extra-urban	8.7	7.3	
	combined	11.3	9.6	
CO ₂ emissions ¹⁰ in g/km	urban	365	318	
	extra-urban	204	171	
	combined	264	225	
Efficiency class/emission standard	F/EU6		E/EU6	

Model	A8 hybrid/A8 L hybrid (155 kW)	
Engine type	4-cylinder inline petrol engine with direct fuel injection, turbocharging and Audi valvelift system	
Displacement in cc (valves per cylinder)	1,984 (4)	
Max. output ¹ in kW at rpm	155/4,200–6,000	
Max. torque in Nm at rpm	350/1,500–4,200	
Hybrid drive		
Electrical output in kW	40 ¹²	
System output in kW	180 ¹²	
Overall torque in Nm	480 ¹²	
Battery type	Lithium-ion battery system	
Battery energy content in kWh	1.25	
Power transmission/wheels		
Drive type	Front-wheel drive	
Transmission type	8-speed tiptronic with integrated electric motor	
Wheels	Cast aluminium wheels, 8 J x 18	
Tyres	235/55 R 18 ²	
Weights/capacities		
Unladen weight ³ in kg	1,945	1,995
Gross vehicle weight in kg	2,510	2,520
Roof load/trailer nose weight in kg	100/–	100/–
Trailer load limit ⁴ in kg	unbraked 12 % gradient	– –
	8 % gradient	– –
Fuel tank capacity, approx. in l	78	78

Model	A8 hybrid/A8 L hybrid (155 kW)	
Performance/consumption ⁵		
Top speed in km/h	235	228
Acceleration 0–100 km/h in s	7.7	7.9
Fuel grade	Sulphur-free super RON 95 ⁷	
Fuel consumption ¹⁰ in l/100 km	urban extra-urban combined	6.1 6.2 6.2
CO ₂ emissions ¹⁰ in g/km	urban extra-urban combined	141 146 144
Efficiency class/emission standard	A/EU6+	A/EU6+

Explanatory notes

¹ The figure given was calculated using the specified measuring procedure (current version of Directive 80/1269/EEC).

² You will find specifications on the technical characteristics of tyres in the adjacent table.

³ Unladen weight includes driver (68 kg), luggage (7 kg) and fuel tank 90% full, calculated in accordance with the current version of Directive 92/21/EEC. Optional equipment may increase the car’s unladen weight and drag coefficient, whereupon the possible payload limit and the top speed will be reduced accordingly.

⁴ The engine’s power output always decreases with increasing altitude. At 1,000 m above sea level, and for every additional 1,000 m, deduct 10 % from the weight of the outfit (trailer load limit + gross weight of the towing vehicle). Figure for trailer load limit applies to factory-fitted trailer towing hitch. If using the vehicle with a trailer towing hitch for commercial purposes, a digital tachograph may be required under certain conditions.

⁵ A vehicle’s fuel consumption and CO₂ emissions do not just depend on how efficiently the vehicle uses the fuel, but are also influenced by driving behaviour and other non-technical factors. CO₂ is the greenhouse gas primarily responsible for global warming.

⁶ Regulated.

⁷ We recommend using sulphur-free super unleaded RON 95 complying with DIN EN 228. If this is not available, use sulphur-free regular unleaded RON 91 complying with DIN EN 228; power output will be slightly reduced. Unleaded RON 95 fuel with a maximum ethanol content of 10 % (E10) can generally be used. Fuel consumption details refer to operation with RON 95 fuel complying with 692/2008/EC.

⁸ We recommend using sulphur-free super plus unleaded RON 98 complying with DIN EN 228. If this is not available, use sulphur-free super unleaded RON 95 complying with DIN EN 228; power output will be slightly reduced. Unleaded RON 95 fuel with a maximum ethanol content of 10 % (E10) can generally be used. Fuel consumption details refer to operation with RON 95 fuel complying with 692/2008/EC.

⁹ We recommend using sulphur-free diesel complying with DIN EN 590. If this is not available, use diesel complying with DIN EN 590.

¹⁰ The figures given were calculated using the specified measuring procedures. The figures do not refer to one individual vehicle and do not form part of any offer, but rather should be used purely for purposes of comparison between the different vehicle models.

¹¹ Refill the separate AdBlue* tank as indicated by the information in the display of the instrument cluster. We recommend having the AdBlue tank refilled by your Audi partner.















¹² Briefly.

Important note

Inspections are due as shown by the service display.

Classifications of tyre parameters

The table shows the range of fuel efficiency, wet grip and exterior noise emission classes for the different tyre sizes of the Audi A8, A8 hybrid, A8 L, A8 L hybrid, A8 L W12 and Audi S8.

	Tyre size	Fuel efficiency class	Wet grip class	Exterior noise emission class	
Summer tyres	235/60 R 17	F–E	B	71	
	235/55 R 18	E–C	C–B	72–68	 – 
	255/45 R 19	E	C–B	73–68	 – 
	265/40 R 20	E–C	B	74–71	 – 
	265/35 R 21	E	B	73	
Winter tyres	275/35 R 21	F–E	B	73–71	
	235/60 R 17	F–E	E	73–72	 – 
	235/55 R 18	E–C	C–B	72–70	
	235/50 R 19	E	C	69–68	
	265/40 R 20	E	C	70	

It is not possible to order a specific tyre.

Ask your Audi partner about the range of tyres available in your country.

^{*}Registered trademark of the Verband der Automobilindustrie e. V. (VDA).

Audi A8/A8 hybrid

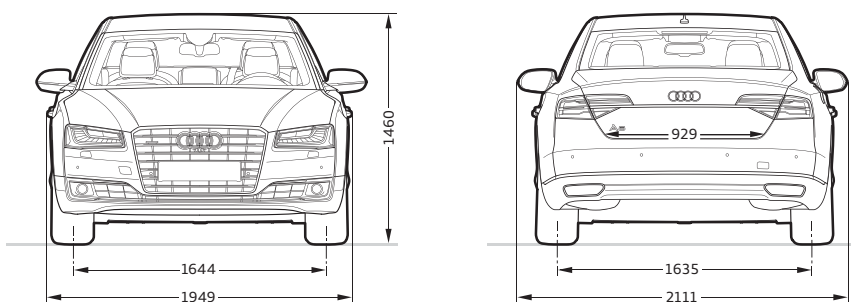
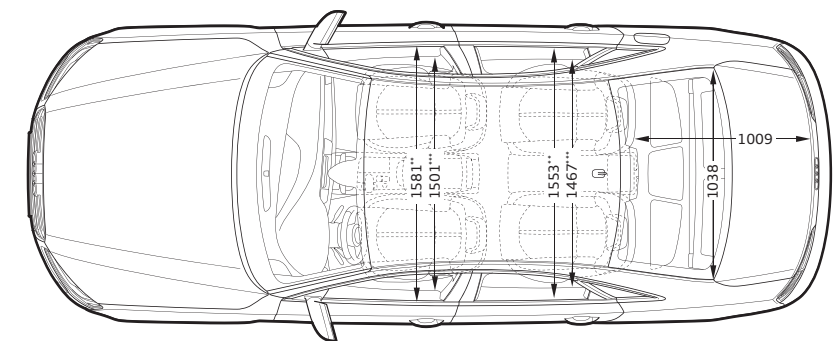
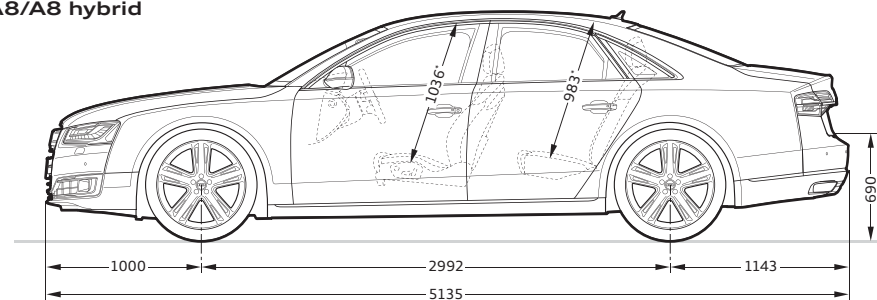
**Dimensions in millimetres.**

Dimensions were measured with vehicle at unladen weight, ground clearance measured with vehicle carrying its maximum load. Luggage compartment volume for the A8 520 l and for the A8 hybrid 335 l. Usable luggage space may be reduced by optional features.

Diesel models with AdBlue¹ tank have 30 l less luggage space.

(Measured by the VDA method using 200 x 100 x 50 mm blocks). Turning circle approx. 12.3 m.

*Maximum headroom, depending on equipment. **Elbow room width. ***Shoulder room width.

Audi A8 L/A8 L hybrid/A8 L W12

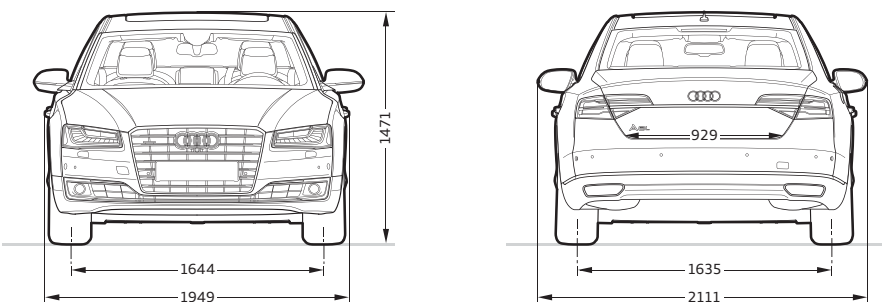
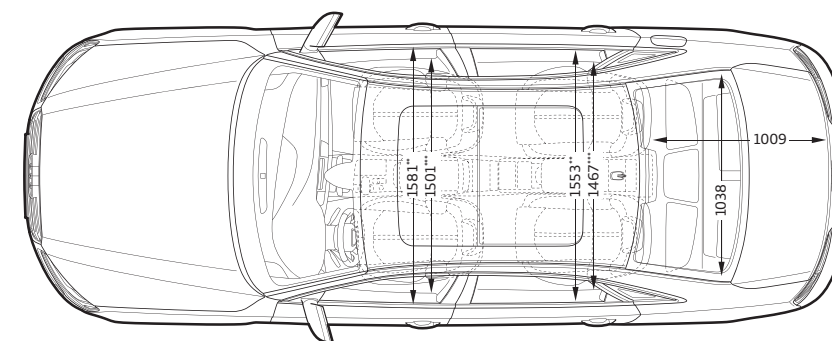
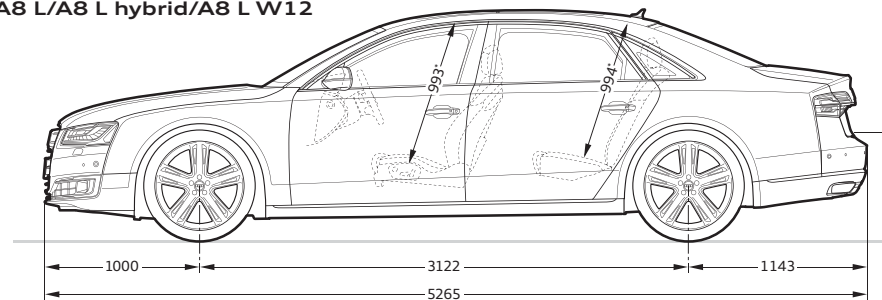
**Dimensions in millimetres.**

Dimensions were measured with vehicle at unladen weight, ground clearance measured with vehicle carrying its maximum load. Luggage compartment volume for the A8 L/A8 L W12 520 l and for the A8 L hybrid 335 l. Usable luggage space may be reduced by optional features.

Diesel models with AdBlue¹ tank have 30 l less luggage space.

(Measured by the VDA method using 200 x 100 x 50 mm blocks). Turning circle approx. 12.7 m.

*Maximum headroom, depending on equipment. **Elbow room width. ***Shoulder room width.



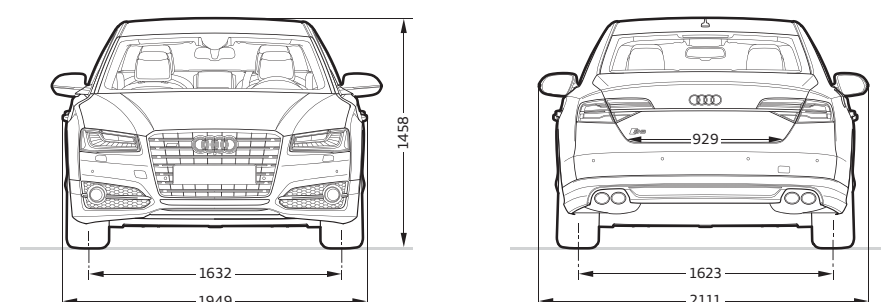
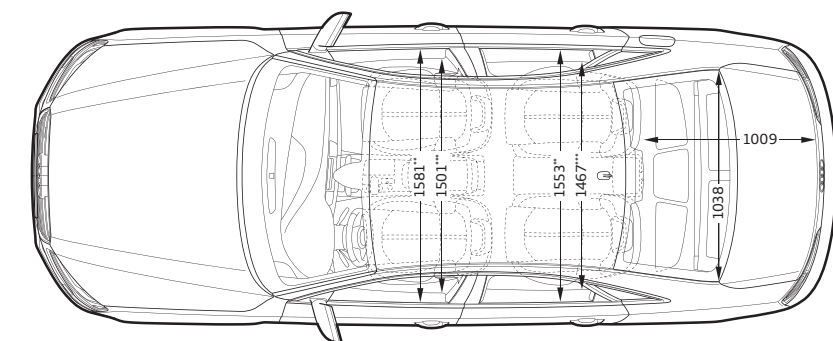
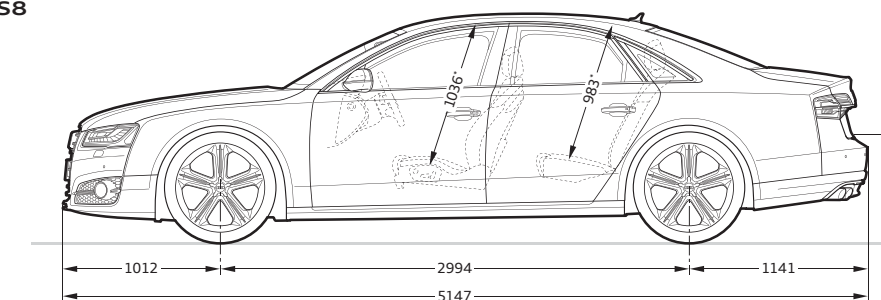











Audi S8









**Dimensions in millimetres.**

Dimensions were measured with vehicle at unladen weight, ground clearance measured with vehicle carrying its maximum load. Luggage compartment volume 520 l. Usable luggage space may be reduced by optional features. (Measured by the VDA method using 200 x 100 x 50 mm blocks). Turning circle approx. 12.7 m.







*Maximum headroom, depending on equipment. **Elbow room width. ***Shoulder room width.

¹Registered trademark of the Verband der Automobilindustrie e. V. (VDA).

	Page	A8	A8 hybrid	S8	A8 L	A8 L hybrid	A8 L W12
Solid paint finishes	66						
 Ibis white		<input type="checkbox"/>	<input type="checkbox"/>	<input type="checkbox"/>	<input type="checkbox"/>	<input type="checkbox"/>	<input type="checkbox"/>
 Brilliant black		<input type="checkbox"/>	<input type="checkbox"/>	<input type="checkbox"/>	<input type="checkbox"/>	<input type="checkbox"/>	<input type="checkbox"/>
Metallic paint finishes	67						
 Havana black, metallic		<input checked="" type="checkbox"/>	<input type="checkbox"/>	<input checked="" type="checkbox"/>	<input checked="" type="checkbox"/>	<input type="checkbox"/>	<input type="checkbox"/>
 Argus brown, metallic		<input checked="" type="checkbox"/>	<input type="checkbox"/>	<input checked="" type="checkbox"/>	<input checked="" type="checkbox"/>	<input type="checkbox"/>	<input type="checkbox"/>
 Moonlight blue, metallic		<input checked="" type="checkbox"/>	<input type="checkbox"/>	<input checked="" type="checkbox"/>	<input checked="" type="checkbox"/>	<input type="checkbox"/>	<input type="checkbox"/>
 Oolong grey, metallic		<input checked="" type="checkbox"/>	<input type="checkbox"/>	<input checked="" type="checkbox"/>	<input checked="" type="checkbox"/>	<input type="checkbox"/>	<input type="checkbox"/>
 Monsoon grey, metallic		<input checked="" type="checkbox"/>	<input type="checkbox"/>	<input checked="" type="checkbox"/>	<input checked="" type="checkbox"/>	<input type="checkbox"/>	<input type="checkbox"/>
 Cuvée silver, metallic		<input checked="" type="checkbox"/>	<input type="checkbox"/>	<input checked="" type="checkbox"/>	<input checked="" type="checkbox"/>	<input type="checkbox"/>	<input type="checkbox"/>
 Floret silver, metallic		<input checked="" type="checkbox"/>	<input type="checkbox"/>	<input checked="" type="checkbox"/>	<input checked="" type="checkbox"/>	<input type="checkbox"/>	<input type="checkbox"/>
 Glacier white, metallic		<input checked="" type="checkbox"/>	<input type="checkbox"/>	<input checked="" type="checkbox"/>	<input checked="" type="checkbox"/>	<input type="checkbox"/>	<input type="checkbox"/>
Pearl effect paint finishes	67						
 Phantom black, pearl effect		<input checked="" type="checkbox"/>	<input type="checkbox"/>	<input checked="" type="checkbox"/>	<input checked="" type="checkbox"/>	<input type="checkbox"/>	<input type="checkbox"/>
 Daytona grey, pearl effect		<input type="checkbox"/>	<input type="checkbox"/>	<input checked="" type="checkbox"/>	<input type="checkbox"/>	<input type="checkbox"/>	<input type="checkbox"/>
Customised paint finishes	64/67						
 Audi exclusive customised paint finishes		<input checked="" type="checkbox"/>	<input checked="" type="checkbox"/>	<input checked="" type="checkbox"/>	<input checked="" type="checkbox"/>	<input checked="" type="checkbox"/>	<input checked="" type="checkbox"/>
Wheels/tyres	68						
 17" forged aluminium wheels in 6-arm design		<input type="checkbox"/> ¹	<input type="checkbox"/>	<input type="checkbox"/>	<input type="checkbox"/> ¹	<input type="checkbox"/>	<input type="checkbox"/>
 18" cast aluminium wheels in 10-spoke V design		<input type="checkbox"/> ²	<input type="checkbox"/>	<input type="checkbox"/>	<input type="checkbox"/> ²	<input type="checkbox"/>	<input type="checkbox"/>

	A8	A8 hybrid	S8	A8 L	A8 L hybrid	A8 L W12
 18" cast aluminium wheels in 10-arm turbine design (hybrid design)	<input type="checkbox"/>	<input type="checkbox"/>	<input type="checkbox"/>	<input type="checkbox"/>	<input type="checkbox"/>	<input type="checkbox"/>
 19" cast aluminium wheels in 5-arm design	<input checked="" type="checkbox"/>	<input checked="" type="checkbox"/>	<input type="checkbox"/>	<input checked="" type="checkbox"/>	<input checked="" type="checkbox"/>	<input type="checkbox"/>
 19" cast aluminium wheels in 10-spoke Y design, partly polished	<input checked="" type="checkbox"/>	<input type="checkbox"/>	<input type="checkbox"/>	<input checked="" type="checkbox"/>	<input type="checkbox"/>	<input checked="" type="checkbox"/>
 19" cast aluminium wheels in 10-arm turbine design (hybrid design), contrasting grey, partly polished	<input type="checkbox"/>	<input checked="" type="checkbox"/>	<input type="checkbox"/>	<input type="checkbox"/>	<input checked="" type="checkbox"/>	<input type="checkbox"/>
 19" cast aluminium wheels in 15-spoke design, partly polished	<input checked="" type="checkbox"/>	<input type="checkbox"/>	<input type="checkbox"/>	<input checked="" type="checkbox"/>	<input type="checkbox"/>	<input checked="" type="checkbox"/>
 20" aluminium technology wheels in 10-arm design, iridium/contrasting grey	<input checked="" type="checkbox"/>	<input checked="" type="checkbox"/>	<input type="checkbox"/>	<input checked="" type="checkbox"/>	<input checked="" type="checkbox"/>	<input checked="" type="checkbox"/>
 20" forged aluminium wheels in 10-parallel-spoke design, partly polished	<input checked="" type="checkbox"/>	<input checked="" type="checkbox"/>	<input type="checkbox"/>	<input checked="" type="checkbox"/>	<input checked="" type="checkbox"/>	<input checked="" type="checkbox"/>
 20" cast aluminium wheels in 5-parallel-spoke design (S design)	<input type="checkbox"/>	<input type="checkbox"/>	<input type="checkbox"/>	<input type="checkbox"/>	<input type="checkbox"/>	<input type="checkbox"/>

	A8	A8 hybrid	S8	A8 L	A8 L hybrid	A8 L W12
 20" forged aluminium wheels in 15-spoke structured design, partly polished	<input checked="" type="checkbox"/>	<input checked="" type="checkbox"/>	<input checked="" type="checkbox"/>	<input checked="" type="checkbox"/>	<input checked="" type="checkbox"/>	<input checked="" type="checkbox"/>
 21" cast aluminium wheels in 5-triple-spoke design (S design)	<input type="checkbox"/>	<input type="checkbox"/>	<input checked="" type="checkbox"/>	<input type="checkbox"/>	<input type="checkbox"/>	<input type="checkbox"/>
 19" Audi exclusive cast aluminium wheels in 5-twin-spoke design	<input checked="" type="checkbox"/>	<input type="checkbox"/>	<input type="checkbox"/>	<input checked="" type="checkbox"/>	<input type="checkbox"/>	<input checked="" type="checkbox"/>
 19" Audi exclusive cast aluminium wheels in 7-twin-spoke design	<input checked="" type="checkbox"/>	<input type="checkbox"/>	<input type="checkbox"/>	<input checked="" type="checkbox"/>	<input type="checkbox"/>	<input checked="" type="checkbox"/>
 20" Audi exclusive cast aluminium wheels in 5-segment-spoke design	<input checked="" type="checkbox"/>	<input type="checkbox"/>	<input checked="" type="checkbox"/>	<input checked="" type="checkbox"/>	<input type="checkbox"/>	<input checked="" type="checkbox"/>
 20" Audi exclusive forged aluminium wheels in 7-twin-spoke design, polished, 2-tone	<input checked="" type="checkbox"/>	<input type="checkbox"/>	<input checked="" type="checkbox"/>	<input checked="" type="checkbox"/>	<input type="checkbox"/>	<input checked="" type="checkbox"/>
 20" Audi exclusive forged aluminium wheels in 7-twin-spoke design, high-gloss polished finish, single colour	<input checked="" type="checkbox"/>	<input type="checkbox"/>	<input checked="" type="checkbox"/>	<input checked="" type="checkbox"/>	<input type="checkbox"/>	<input checked="" type="checkbox"/>
 20" Audi exclusive cast aluminium wheels in 10-Y-spoke design	<input checked="" type="checkbox"/>	<input type="checkbox"/>	<input checked="" type="checkbox"/>	<input checked="" type="checkbox"/>	<input type="checkbox"/>	<input checked="" type="checkbox"/>
 21" Audi exclusive cast aluminium wheels in 5-arm structured design	<input checked="" type="checkbox"/>	<input type="checkbox"/>	<input checked="" type="checkbox"/>	<input checked="" type="checkbox"/>	<input type="checkbox"/>	<input checked="" type="checkbox"/>

	A8	A8 hybrid	S8	A8 L	A8 L hybrid	A8 L W12
 21" Audi exclusive cast aluminium wheels in 5-arm rotor design	<input checked="" type="checkbox"/>	<input type="checkbox"/>	<input checked="" type="checkbox"/>	<input checked="" type="checkbox"/>	<input type="checkbox"/>	<input checked="" type="checkbox"/>
 21" Audi exclusive cast aluminium wheels in 5-arm rotor design, matt titanium look, gloss turned finish	<input checked="" type="checkbox"/>	<input type="checkbox"/>	<input checked="" type="checkbox"/>	<input checked="" type="checkbox"/>	<input type="checkbox"/>	<input checked="" type="checkbox"/>
 17" cast aluminium winter wheels in 6-arm design	<input checked="" type="checkbox"/>	<input type="checkbox"/>	<input type="checkbox"/>	<input checked="" type="checkbox"/>	<input type="checkbox"/>	<input type="checkbox"/>
 18" cast aluminium winter wheels in 7-arm design	<input checked="" type="checkbox"/>	<input checked="" type="checkbox"/>	<input type="checkbox"/>	<input checked="" type="checkbox"/>	<input checked="" type="checkbox"/>	<input type="checkbox"/>
 19" cast aluminium winter wheels in 5-arm design	<input checked="" type="checkbox"/>	<input type="checkbox"/>	<input checked="" type="checkbox"/>	<input checked="" type="checkbox"/>	<input type="checkbox"/>	<input checked="" type="checkbox"/>
 20" cast aluminium winter wheels in 5-parallel-spoke design (S design)	<input type="checkbox"/>	<input type="checkbox"/>	<input checked="" type="checkbox"/>	<input type="checkbox"/>	<input type="checkbox"/>	<input type="checkbox"/>
 20" forged aluminium winter wheels in 10-parallel-spoke design	<input checked="" type="checkbox"/>	<input type="checkbox"/>	<input type="checkbox"/>	<input checked="" type="checkbox"/>	<input type="checkbox"/>	<input checked="" type="checkbox"/>
Run-flat tyres	<input checked="" type="checkbox"/>	<input type="checkbox"/>	<input type="checkbox"/>	<input checked="" type="checkbox"/>	<input type="checkbox"/>	<input checked="" type="checkbox"/>
Anti-theft wheel bolts	<input type="checkbox"/>	<input type="checkbox"/>	<input type="checkbox"/>	<input type="checkbox"/>	<input type="checkbox"/>	<input type="checkbox"/>
Tyre repair kit	<input type="checkbox"/>	<input type="checkbox"/>	<input type="checkbox"/>	<input type="checkbox"/>	<input type="checkbox"/>	<input type="checkbox"/>
Spare wheel, space-saving	<input checked="" type="checkbox"/>	<input type="checkbox"/>	<input checked="" type="checkbox"/>	<input checked="" type="checkbox"/>	<input type="checkbox"/>	<input checked="" type="checkbox"/>
Tyre pressure loss indicator	<input type="checkbox"/>	<input type="checkbox"/>	<input type="checkbox"/>	<input type="checkbox"/>	<input type="checkbox"/>	<input type="checkbox"/>
Vehicle tool kit	<input type="checkbox"/>	<input type="checkbox"/>	<input type="checkbox"/>	<input type="checkbox"/>	<input type="checkbox"/>	<input type="checkbox"/>
Vehicle jack	<input checked="" type="checkbox"/>	<input type="checkbox"/>	<input checked="" type="checkbox"/>	<input checked="" type="checkbox"/>	<input type="checkbox"/>	<input checked="" type="checkbox"/>

Standard equipment Optional equipment Standard/optional equipment varies by model Not available

Country-specific variations possible. Please find out from your local Audi partner which equipment is standard and what optional equipment is available in your country.

More detailed descriptions of a selection of items from the equipment range can be found on page 52 onwards.

¹Standard for 6-cylinder models. ²Standard for 8-cylinder models.

	Page	A8	A8 hybrid	S8	A8 L	A8 L hybrid	A8 L W12
Seats for driver and front passenger	70						
Standard seats, front		□	□	—	□	□	—
Comfort seats, front		■	■	■	■	■	□
Comfort seats, front with seat ventilation		■	■	■	■	■	■
Comfort sport seats, front		■	■	□	■	■	■
Comfort sport seats, front with seat ventilation		■	■	■	■	■	■
Seat upholstery for standard seats, front	72						
Verdi cloth		□	□	—	□	□	—
Valcona leather, black		■	■	—	■	■	—
Valcona leather, velvet beige		■	■	—	■	■	—
Seat upholstery for comfort seats, front	72						
Valcona leather, black		■	■	■	■	■	□
Valcona leather, nougat brown		■	■	■	■	■	□
Valcona leather, nutmeg		■	■	■	■	■	□
Valcona leather, titanium grey		■	■	■	■	■	□
Valcona leather, velvet beige		■	■	■	■	■	□
Valcona leather, Atlas beige		■	■	■	■	■	□
Audi exclusive leather upholstery and trim		■	■	■	■	■	■
Seat upholstery for comfort seats, front with seat ventilation	72						
Valcona leather, black		■	■	■	■	■	■
Valcona leather, nougat brown		■	■	■	■	■	■
Valcona leather, nutmeg		■	■	■	■	■	■
Valcona leather, titanium grey		■	■	■	■	■	■
Valcona leather, velvet beige		■	■	■	■	■	■
Valcona leather, Atlas beige		■	■	■	■	■	■
Valcona leather, Balao brown/snow white		■ ¹	■ ¹	■ ¹	■ ¹	■ ¹	■ ¹

	Page	A8	A8 hybrid	S8	A8 L	A8 L hybrid	A8 L W12
Valcona leather, sycamore grey/brass gold		■ ¹	■ ¹	■ ¹	■ ¹	■ ¹	■ ¹
Natural leather, black		■	■	■	■	■	■
Natural leather, nougat brown		■	■	■	■	■	■
Natural leather, velvet beige		■	■	■	■	■	■
Audi exclusive leather upholstery and trim		■	■	■	■	■	■
Seat upholstery for comfort sport seats, front with and without seat ventilation	72						
Valcona leather, black		■	■	□	■	■	■
Valcona leather, nougat brown		■	■	□	■	■	■
Valcona leather, titanium grey		■	■	□	■	■	■
Valcona leather, lunar silver/steel grey		—	—	□	—	—	—
Valcona leather, velvet beige		■	■	□	■	■	■
Valcona leather, Vermont brown/granite grey		—	—	■ ¹	—	—	—
Unicum leather, nutmeg ²		■	■	■	■	■	■
Audi exclusive leather upholstery and trim		■	■	■	■	■	■
Leather packages	74						
Leather package		■	■	□	■	■	—
Extended leather package		■	■	■	■	■	□
Full-leather package		■	■	■	■	■	■
Audi exclusive leather upholstery and trim (package 1)		■	■	■	■	■	■
Audi exclusive leather upholstery and trim (package 2)		■	■	■	■	■	■
Audi exclusive leather upholstery and trim (package 3)		■	■	■	■	■	■
Audi exclusive leather upholstery and trim (package 4)		■	■	■	■	■	■
Headlining	74						
Headlining in cloth		□	□	□	□	□	—
Headlining in black cloth		■	■	■	■	■	—

	Page	A8	A8 hybrid	S8	A8 L	A8 L hybrid	A8 L W12
Headlining and rear parcel shelf in Alcantara		■	■	■	■	■	□
Headlining and rear parcel shelf in Alcantara, black		■	■	■	■	■	■
Audi exclusive headlining in Alcantara		■	■	■	■	■	■
Audi exclusive rear shelf in Alcantara		■	■	■	■	■	■
Audi design selection	75						
Audi design selection sycamore grey		■	■	■	■	■	■
Audi design selection Balao brown		■	■	■	■	■	■
Audi design selection Vermont brown		—	—	■	—	—	—
Upper/lower inlays	76						
Walnut, dark brown/high-gloss black		□	□	■	□	□	■
Vavona, Assam grey/high-gloss black		■	■	■	■	■	■
Poplar, brown silver/high-gloss black		■	■	■	■	■	■
Fine grain ash, natural gold brown/high-gloss black		■	■	■	■	■	■
Piano finish black/high-gloss black		■	■	■	■	■	■
Carbon Atlas/high-gloss black		—	—	■	—	—	—
Fine grain birch, pearl beige/high-gloss black		■ ³	■ ³	■ ³	■ ³	■ ³	■ ³
Fine grain ash, velvet brown/high-gloss black		■ ³	■ ³	■ ³	■ ³	■ ³	■ ³
Walnut, dark brown/brushed aluminium, silver		■	■	■	■	■	■
Vavona, Assam grey/brushed aluminium, silver		■	■	■	■	■	■

	Page	A8	A8 hybrid	S8	A8 L	A8 L hybrid	A8 L W12
Poplar, brown silver/brushed aluminium, silver		■	■	■	■	■	■
Fine grain ash, natural gold brown/brushed aluminium, silver		■	■	■	■	■	■
Piano finish, black/brushed aluminium, silver		■	■	■	■	■	□
Carbon Atlas/brushed aluminium, silver		—	—	□	—	—	—
Carbon twill, copper/brushed aluminium, silver		—	—	■ ¹	—	—	—
Fine grain ash, natural balsamic brown/brushed aluminium, silver		■ ¹	■ ¹	■ ¹	■ ¹	■ ¹	■ ¹
Fine grain ash, natural pearl grey/brushed aluminium, silver		■ ¹	■ ¹	■ ¹	■ ¹	■ ¹	■ ¹
Fine grain birch, pearl beige/brushed aluminium, silver		■ ³	■ ³	■ ³	■ ³	■ ³	■ ³
Fine grain ash, velvet brown/brushed aluminium, silver		■ ³	■ ³	■ ³	■ ³	■ ³	■ ³
Audi exclusive inlays		■	■	■	■	■	■
Grab handles with wooden segments		■	■	■	■	■	□
Audi exclusive grab handles with wooden segments		■	■	■	■	■	■
Aluminium look in the interior		□	□	—	□	□	—
Extended aluminium look in the interior		■	■	□	■	■	□
Technology	78						
tiptronic		□	□	□	□	□	□
quattro®		□	—	—	□	—	□
quattro® with sport differential		□ ⁴	—	□	□ ⁴	—	■
adaptive air suspension.		□	□	—	□	□	□
adaptive air suspension sport		■	■	□	—	—	—

□ Standard equipment ■ Optional equipment □■ Standard/optional equipment varies by model — Not available

Country-specific variations possible. Please find out from your local Audi partner which equipment is standard and what optional equipment is available in your country.

More detailed descriptions of a selection of items from the equipment range can be found on page 52 onwards.

¹ Can only be ordered in conjunction with an Audi design selection. ² For information on when this feature will be available, please contact your Audi partner. ³ From quattro GmbH. ⁴ Standard on 4.2 TDI clean diesel quattro.

	Page	A8	A8 hybrid	S8	A8 L	A8 L hybrid	A8 L W12
Technology (continued)	78						
Audi drive select		☐	☐	☐	☐	☐	☐
Electromechanical parking brake		☐	☐	☐	☐	☐	☐
Electromechanical power steering		☐	☐	–	☐	☐	☐
Dynamic steering		■	–	☐	■	–	■
Brake system		☐	☐	☐	☐	☐	☐
Ceramic brake		■ ¹	–	■	■ ¹	–	■
Start-stop system		☐	☐ ²	☐	☐	☐ ²	☐
Audi TDI clean diesel		☐ ³	–	–	☐ ³	–	–
Recuperation		☐	☐ ²	☐	☐	☐ ²	☐
Misfuelling protection		☐ ³	–	–	☐ ³	–	–
Audi cylinder on demand		☐ ⁴	–	☐	☐ ⁴	–	☐
Active Noise Cancellation		☐ ⁵	☐	☐	☐ ⁵	☐	☐
Audi Space Frame (ASF®) body		☐	☐	☐	☐	☐	☐
Antilock Brake System (ABS)		☐	☐	☐	☐	☐	☐
Anti-Slip Regulation (ASR)		☐	☐	☐	☐	☐	☐
Electronic Differential Lock (EDL)		☐	☐	☐	☐	☐	☐
Electronic Stabilisation Control (ESC)		☐	☐	☐	☐	☐	☐
Lights	79						
Xenon plus		☐	–	–	☐	–	–
LED headlights		■	☐	☐	■	☐	☐
Audi Matrix LED headlights		■	■	■	■	■	☐
Light/rain sensor		☐	☐	☐	☐	☐	☐
LED rear lights		☐	☐	☐	☐	☐	☐
LED rear lights with dynamic indicators		■ ⁶	■ ⁶	■ ⁶	■ ⁶	■ ⁶	■ ⁶

☐ Standard equipment ■ Optional equipment ☐ Standard/optional equipment varies by model – Not available

Country-specific variations possible. Please find out from your local Audi partner which equipment is standard and what optional equipment is available in your country.

More detailed descriptions of a selection of items from the equipment range can be found on page 52 onwards.

	Page	A8	A8 hybrid	S8	A8 L	A8 L hybrid	A8 L W12
Adaptive brake light		☐	☐	☐	☐	☐	☐
Interior and exterior lighting package		☐	☐	☐	☐	☐	☐
Ambient lighting		■	☐	☐	■	☐	☐
Design	80						
Exhaust tailpipes, dual-branch design with trapezoidal chrome surrounds integrated into the bumper		☐	☐	–	☐	☐	☐
Exhaust tailpipes, dual-branch design, 2 oval chrome surrounds on both left and right		–	–	☐	–	–	–
Door sill trims with aluminium inlays		☐	–	–	☐	–	–
Door sill trims with aluminium inlays with model-specific illuminated logo		–	☐	☐	–	☐	☐
Audi exclusive personalised door sill trims, front		■	■	■	■	■	■
Audi exclusive personalised door sill trims, front and rear		■	■	■	■	■	■
Operation	80						
Remote control key		☐	☐	–	☐	☐	–
Convenience key including sensor-controlled release of the luggage compartment lid		■	■	☐	■	■	☐
Power-assisted closing for the doors		■	■	■	■	■	☐
Power-assisted closing for the luggage compartment lid		☐	☐	☐	☐	☐	☐
Luggage compartment lid, automatically opening		☐	☐	☐	☐	☐	☐
Luggage compartment lid, electric opening and closing		■	■	■	■	■	☐
Garage door opener (HomeLink)		■	■	■	■	■	■
Engine start-stop button		☐	☐	☐	☐	☐	☐
Multifunction leather steering wheel in 4-spoke design with shift paddles		☐	☐	■	☐	☐	☐
Multifunction leather steering wheel in 4-spoke design with shift paddles, heated		■	■	■	■	■	■

	Page	A8	A8 hybrid	S8	A8 L	A8 L hybrid	A8 L W12
Multifunction sport leather steering wheel in 3-spoke design with shift paddles		■	■	☐	■	■	■
Multifunction sport leather steering wheel in 3-spoke design with shift paddles, heated		■	■	■	■	■	■
Electric steering wheel adjustment		☐	☐	☐	☐	☐	☐
Steering wheel rim with wooden segments		■	■	■	■	■	■
Audi exclusive steering wheel rim with wooden segments		■	■	■	■	■	■
Audi exclusive leather steering wheel		■	■	■	■	■	■
Selector lever in leather		☐	☐	■	☐	☐	☐
Selector lever in wood		■ ⁷	■ ⁷	■ ⁷	■ ⁷	■ ⁷	■ ⁷
Audi exclusive selector lever in wood		■	■	■	■	■	■
Selector lever in carbon Atlas		–	–	☐	–	–	–
Selector lever in piano finish, black		–	–	–	–	–	☐
Audi exclusive leather controls		■	■	■	■	■	■
Comfort	82						
Slide-and-tilt glass sunroof		■	■	■	☐	☐	☐
Solar slide-and-tilt sunroof		■	■	■	■	■	■
Panoramic glass sunroof		–	–	–	■	■	■
Heat-insulating glass		☐	☐	–	☐	☐	–
Double/acoustic glazing		■	■	☐	■	■	■
Insulating/acoustic glass		■	■	■	■	■	☐
Insulating/acoustic glass with windscreen heater		■	–	■	■	–	■
Dark-tinted windows (privacy glazing)		■	■	■	■	■	■
Sunblind, electric for the rear window		■	■	■	–	–	–
Sunblinds, electric, for the rear window and rear door windows		■	■	■	☐	☐	☐
Seat heating, front		■	■	☐	■	■	–
Seat heating, front and rear		■	■	■	■	■	☐

¹ Only available for 8-cylinder models. ² Hybrid technology. ³ Only available for diesel models. ⁴ Only available for 4.0 TFSI quattro. ⁵ Standard for 4.0 TFSI quattro. ⁶ Only available in conjunction with Audi Matrix LED headlights.

⁷ Cannot be ordered in conjunction with inlays specified as natural. ⁸ Only available in conjunction with comfort sport seats, front.

	A8	A8 hybrid	S8	A8 L	A8 L hybrid	A8 L W12
Seat ventilation, front	■	■	■	■	■	■
Seat ventilation, front and rear	■	–	■	■	■	■
Massage function, front	■	■	■	■	■	■
Massage function, front and rear	■	–	■	■	■	■
Centre armrest, front	☐	☐	–	☐	☐	–
Comfort centre armrest, front	■	■	☐	■	■	☐
Centre armrest, rear	☐	☐	☐	☐	☐	☐
Comfort head restraints, rear	■	■	■	■	■	☐
Memory function for standard seats, front	■	■	–	■	■	–
Rear seat system	☐	☐	☐	☐	☐	■
ISOFIX child seat mounting and Top Tether for the outer rear seats	☐	☐	☐	☐	☐	☐
Individual seat package, rear	■	■	■	■	■	☐
Individual seat package, rear with full-length leather-covered centre console	–	–	–	■	■	■
Relaxation seat package, rear with full-length leather-covered centre console	–	–	–	■	■	■
Rear seat package in sport seat look	■ ⁸	■ ⁸	■	■ ⁸	■ ⁸	■ ⁸
Audi exclusive folding table	■	■	■	■	■	■
Audi exclusive personalisation of the folding table	■	■	■	■	■	■
230V/115V/100V socket	■	■	■	■	■	■
Additional reading lights in the rear	■	■	■	■	■	☐
Vanity mirrors in the rear	–	–	–	■	■	☐
Audi exclusive cardan reading lights in the rear	■	■	■	■	■	■
Deluxe automatic air conditioning	☐	–	☐	☐	–	–
3-zone deluxe automatic air conditioning	–	☐	–	–	☐	–
4-zone deluxe automatic air conditioning	■	–	■	■	–	☐

	Page	A8	A8 hybrid	S8	A8 L	A8 L hybrid	A8 L W12
Comfort (continued)	82						
Auxiliary heating/ventilation		■	—	■	■	—	■
Ioniser		■	■	■	■	■	■
Audi exclusive storage compartment		—	—	—	■	—	■
Audi exclusive bar compartment		—	—	—	■	—	■
Audi exclusive coolbox		■	—	■	■	—	■
Footrests, rear		—	—	—	■	■	■
Audi exclusive rear footrests		—	—	—	■	■	■
Floor mats, front and rear		□	□	□	□	□	□
Audi exclusive floor mats		■	■	■	■	■	■
Audi exclusive carpet and floor mats		■	■	■	■	■	■
Cigarette lighter and ashtray		□	□	□	□	□	□
Non-smoker package		■	■	■	■	■	■
Transport	86						
A8 hybrid luggage set		—	□	—	—	□	—
Provision for trailer towing hitch ¹		■	—	■	■	—	■
Trailer towing hitch, electrically swivelling		■	—	■	■	—	■
Luggage compartment package		■	■ ²	■	■	■ ²	■
Storage compartments		□	□	□	□	□	□
Cup holder		□	□	□	□	□	□
Through-loading facility		■	—	■	■	—	■
Through-loading facility with removable ski/snowboard bag		■	—	■	■	—	■
Safety	87						
Exterior mirrors with integrated LED indicator, electrically adjustable, heated and folding, including automatic kerb-side function for the exterior mirror on the passenger side		□	□	□	□	□	□
Exterior mirrors additionally automatically dimming on both sides		■	■	—	■	■	—

□ Standard equipment ■ Optional equipment □ Standard/optional equipment varies by model — Not available

Country-specific variations possible. Please find out from your local Audi partner which equipment is standard and what optional equipment is available in your country.

More detailed descriptions of a selection of items from the equipment range can be found on page 52 onwards.

	Page	A8	A8 hybrid	S8	A8 L	A8 L hybrid	A8 L W12
Exterior mirrors additionally automatically dimming on both sides with memory function		■	■	□	■	■	□
Interior mirror, automatically dimming		□	□	□	□	□	□
Side impact protection		□	□	□	□	□	□
Airbags		□	□	□	□	□	□
Deactivation switch for front-passenger airbag		■	■	■	■	■	■
Integrated head restraint system		□	□	□	□	□	□
Seat belts		□	□	□	□	□	□
Audi exclusive seat belts		■	■	■	■	■	■
Anti-theft alarm		□	□	□	□	□	□
Preparation for tracking system		■	■	■	■	■	■
Warning and control lights		□	□	□	□	□	□
Warning triangle		□	□	□	□	□	□
First-aid kit		□	□	□	□	□	□
Assistance systems	87						
Cruise control		□	□	□	□	□	□
Secondary collision brake assist		□	□	□	□	□	□
Audi pre sense basic		□	□	□	□	□	□
adaptive cruise control with Stop&Go function including Audi pre sense front		■	■	■	■	■	■
Audi side assist including Audi pre sense rear		■	■	■	■	■	■
Audi active lane assist		■	■	■	■	■	■
Head-up display		■	■	■	■	■	■
Night vision assistant		■	■	■	■	■	■
Camera-based speed limit display		■	■	■	■	■	■
Parking system plus		■	■	□	■	■	□
Park assist with display of surroundings		■	■	■	■	■	■

	Page	A8	A8 hybrid	S8	A8 L	A8 L hybrid	A8 L W12
Reversing camera		■	■	■	■	■	□
360 degree cameras		■	■	■	■	■	■
Assistance package including Audi pre sense plus		■	■	■	■	■	■
Hold assist		□	□	□	□	□	□
Infotainment	89						
Powermeter in the instrument cluster		—	□	—	—	□	—
Instrument cluster		□	—	□	□	—	□
Driver information system with colour display		□	□	□	□	□	□
Attention assist		□	□	□	□	□	□
MMI®		□	□	□	□	□	—
MMI® touch		■	■	■	■	■	—
MMI® navigation plus with MMI touch		■	■	■	■	■	□
Audi music interface		■	■	■	■	■	□
Navigation data (hard drive)		■	■	■	■	■	□
Bluetooth interface		■	■	■	■	■	□
Preparation for mobile phone (Bluetooth)		■	■	■	■	■	■
Audi connect including car phone		■	■	■	■	■	□
Handset in the front for car phone		■	■	■	■	■	□
Handsets in the front and rear for car phone		■	■	■	■	■	■
Mobile phone holder		—	—	—	—	—	□
MMI® radio plus		□	□	□	□	□	□
Digital Audio Broadcasting		■	■	■	■	■	■
Digital TV reception		■	■	■	■	■	■
Audi sound system		□	—	□	□	—	—
Bose surround sound		■	□	■	■	□	□
Bang & Olufsen Advanced Sound System		■	■	■	■	■	■

	Page	A8	A8 hybrid	S8	A8 L	A8 L hybrid	A8 L W12
DVD/CD changer		■	■	□	■	■	□
Rear Seat Entertainment		■	—	■	■	■	■
Audi Extended Warranty	91						
Audi Extended Warranty		■	■	■	■	■	■

Equipment for the Audi A8 illustrated (p. 4–13):

Paint finish: floret silver, metallic

Wheels: aluminium technology wheels in 10-arm design, iridium/contrasting grey

Seat upholstery: Valcona leather, Atlas beige

Inlays: upper inlay in poplar, brown silver;
lower inlay in high-gloss black; extended aluminium look in the interior

Equipment for the Audi A8 L illustrated (p. 14–17):

Paint finish: Oolong grey, metallic

Wheels: forged aluminium wheels in 10-parallel-spoke design, partly polished

Seat upholstery: Unicum leather, nutmeg

Inlays: upper inlay in walnut, dark brown;
lower inlay in brushed aluminium, silver

Equipment for the Audi A8 L W12 illustrated (p. 18–23):

Paint finish: phantom black, pearl effect

Wheels: forged aluminium wheels in 15-spoke structured design

Seat upholstery: Valcona leather, velvet beige

Inlays: upper inlay in fine grain ash, natural gold brown;
lower inlay in brushed aluminium, silver; extended aluminium look in the interior

Equipment for the Audi S8 illustrated (p. 24–31):

Paint finish: Daytona grey, pearl effect

Wheels: cast aluminium wheels in 5-triple-spoke design (S design)

Seat upholstery: Valcona leather, Vermont brown/granite grey (Audi design selection)

Inlays: upper inlay in carbon twill, copper;
lower inlay in brushed aluminium, silver; extended aluminium look in the interior;
headlining and rear parcel shelf in Alcantara, black

¹The trailer towing hitch for retrofitting is available from Audi Genuine Accessories. ²Not available in conjunction with A8 hybrid luggage set.



Responsibility

Living up to our responsibilities is a principle that is firmly anchored in Audi strategy. Alongside commercial success and international competitiveness, our responsibility toward company employees and society as a whole is a key consideration, as is protecting the environment and conserving resources. And what is true in the details – our catalogues are printed on FSC-certified paper – also holds in general: Audi develops cars that are not only sporty and emotive but also ever more efficient. In the long run, Audi wants its products

to allow CO₂-neutral mobility. Seeing to it that production in Audi plants gradually becomes CO₂-neutral is another aspect of our comprehensive approach. Audi is also committed to society – particularly in the fields of education, technology and social projects. At Audi, sustainability is closely linked with how we see the future: the Audi Urban Future Initiative sees Audi working with international experts to get to the root of future urban challenges and trends in mobility.

Discover the world of Audi.



Choosing an Audi means choosing a brand that offers more. More individuality. More exclusivity. More fascination.

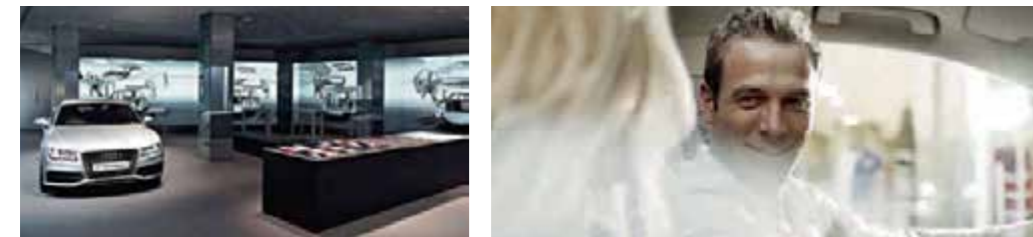

The Audi experience

The fascination of Audi can be experienced in many different ways. Audi City in London, for example, gives you digital access to all models at their actual size and in real time. And of course it is always worth visiting one of the major motor shows. This is where Audi always presents its new models and invites you to take a look at how the future is being shaped with “Vorsprung durch Technik”. Anyone interested in seeing how Audi is already putting this into practice will find fascinating insight in the “Vorsprung durch Technik” online special at www.audi.com. But a look back can also be rewarding:

at the Audi mobile museum in Ingolstadt, history and high-tech go hand in hand. A total of 130 historic exhibits and state-of-the-art forms of presentation make for a thrilling symbiosis. Plus, Audi driving experience allows you to live the excitement and countless possibilities of current Audi models. Here, pure driving enjoyment is combined with valuable learning effects. This is ensured by a team of specially trained and highly qualified instructors who provide practical tips to help you optimise your driving skills.



Team spirit

Motorsport is a driving force behind the brand. For years Audi has been among the champions in various racing series, for instance the 24 Hours of Le Mans or the DTM German Touring Car Masters. The values that are crucial in many different areas of sports are also central ones for Audi: precision, passion and technology. No coincidence then that Audi has been sponsoring sporting

events for many years. In the world of winter sports, for example, Audi has been the main sponsor of the German Ski Association (DSV) for almost three decades and has also partnered 14 other national alpine teams. In football, we support national and international teams. And Audi is also a partner for the German Olympic Sports Confederation.

www.audi.com

Information on all the topics mentioned above can be found on our website: www.audi.com.

- www.audi.com
- configurator.audi.com
- www.audi.com/vorsprung-durch-technik
- www.audi.com/driving
- www.audi.com/cr

Equipment Audi A8/A8 L/A8 L W12/S8			
230V/115V/100V socket	83	Audi side assist including Audi pre sense rear	87
360 degree cameras	88	Audi Singleframe	55
A8 hybrid luggage set	86	Audi sound system	90
Active Noise Cancellation	78	Audi Space Frame (ASF®) body	78
adaptive air suspension	78	Audi TDI clean diesel	78
adaptive air suspension sport	55, 78	Auxiliary heating/ventilation	85
Adaptive brake light	104	Bang & Olufsen Advanced Sound System	90
adaptive cruise control with Stop&Go function		Bluetooth interface	90
including Audi pre sense front	87	Bose surround sound	90
Additional reading lights in the rear	85	Brake callipers painted black, with S8 logo	55
Airbags	106	Brake system	104
Aluminium look in the interior	76	Bumpers	55
Ambient lighting	79	Camera-based speed limit display	88
Anti-Slip Regulation (ASR)	104	Centre armrests	105
Anti-theft alarm	87	Ceramic brake	78
Anti-theft wheel bolts	101	Cigarette lighter and ashtray	83
Antilock Brake System (ABS)	104	Cloth/leather upholstery and trim	72, 73
Assistance package including Audi pre sense plus	88	Comfort centre armrest, front	83
Attention assist	107	Comfort head restraints, rear	83
Audi active lane assist	87	Comfort seats, front	71
Audi connect including car phone	89	Comfort sport seats, front	71
Audi cylinder on demand	104	Convenience key with sensor-controlled release of the luggage compartment lid	80
Audi design selection Balao brown	60, 75	Cruise control system	87
Audi design selection sycamore grey	59, 75	Cup holders	106
Audi design selection Vermont brown	61, 75	Dark-tinted windows (privacy glazing)	82
Audi drive select	78	Deactivation switch for front passenger airbag	106
Audi exclusive	62-65	Deluxe automatic air conditioning systems	85
Audi exclusive bar compartment	86	Digital Audio Broadcasting	90
Audi exclusive cardan reading lights in rear	85	Digital TV reception	90
Audi exclusive carpet and floor mats	83	Door sill trims with aluminium inlays	55, 80
Audi exclusive cool box	86	Double/acoustic glazing	82
Audi exclusive fold-away table	83	Driver information system with colour display	89
Audi exclusive leather controls	81	DVD/CD changer	90
Audi exclusive leather upholstery and trim	74	Dynamic steering	55, 78
Audi exclusive personalisation of the fold-away table	83	Electric steering wheel adjustment	105
Audi exclusive personalised door sill trims, front and rear	80	Electromechanical parking brake	104
Audi exclusive rear parcel shelf in Alcantara	74	Electromechanical power steering	78
Audi exclusive seat belts	87	Electronic Differential Lock (EDL)	104
Audi exclusive storage compartment	83	Electronic Stabilisation Control (ESC)	104
Audi extended warranty	91	Engine start/stop button, S-specific	55
Audi Genuine Accessories	92, 93	Exhaust tailpipes	55, 104
Audi Matrix LED headlights	79	Extended aluminium look in the interior	76
Audi music interface	90	Exterior mirror housings	55
Audi pre sense basic	87	Exterior mirrors	106

Equipment Audi A8/A8 L/A8 L W12/S8

First-aid kit	106	Power-assisted closing for the doors	80
Floor mats	83, 106	Power-assisted closing for the luggage compartment lid	104
Footrests, rear	83	Powermeter in the instrument cluster	107
Garage door opener (HomeLink)	80	Preparation for mobile phone (Bluetooth)	90
Grab handles with wooden segments	76	Preparation for tracking system	106
Handset in the front and rear for car phone	90	Provision for trailer towing hitch	106
Handset in the front for car phone	90	quattro®/quattro® with sport differential	55, 78
Head-up display	88	Rear Seat Entertainment	91
Headlining	74, 102	Rear seat packages	84
Heat-insulating glass	105	Rear seat system	84
Hold assist	107	Recuperation	104
Inlays	55, 76, 77	Remote control key	80
Instrument cluster, S-specific	55	Reversing camera	88
Insulating/acoustic glass	82	Run-flat tyres	101
Integrated head restraint system	106	S8-specific analogue clock with grey dial	55
Interior and exterior lighting package	79	Seat belts	106
Interior mirror, automatically dimming	106	Seat heating systems	83
Ioniser	85	Seat ventilation systems	83
ISOFIX child seat mounting and Top Tether for the outer rear seats	83	Secondary collision brake assist	87
Leather packages	74	Selector levers	55, 81, 105
LED headlights	79	Side impact protection	106
LED rear lights	79	Slide-and-tilt glass sunroof	82
LED rear lights with dynamic indicators	79	Solar slide-and-tilt sunroof	82
Light/rain sensor	104	Spare wheel, space-saving	101
Luggage compartment lid, automatically opening	104	Standard seats, front	70
Luggage compartment lid with electric opening and closing function	80	Start-stop system	78
Luggage compartment package	86	Steering wheel rims with wooden segments	81
Massage functions	83	Steering wheels	55, 80, 81
Memory function for standard seats, front	83	Storage compartments	106
Misfuelling protection	104	Sunblinds	82
MMI®	89	Through-loading facility	87
MMI® navigation plus with MMI touch	89	Through-loading facility with removable ski/snowboard bag	87
MMI® radio plus	90	tiptronic	78
MMI® touch	89	Trailer towing hitch	86
Mobile phone holder	107	Tyre pressure loss indicator	101
Model name/logo	55	Tyre repair kit	101
Navigation data (hard drive)	107	Vanity mirrors and additional reading lights in the rear	85
Night vision assistant	88	Vehicle jack	101
Non-smoker package	83	Vehicle tool kit	101
Paint finishes	55, 66, 67	Warning and control lights	106
Panoramic glass sunroof	82	Warning triangle	106
Park assist with display of surroundings	88	Wheels/tyres	55, 68, 69
Parking system plus	88	Xenon plus	79
Pedals and footrest in stainless steel	55		

AUDI AG
85045 Ingolstadt
www.audi.com
Valid from November 2013

Printed in Germany
333/1330.82.18

The models and equipment versions illustrated and described in this brochure and some of the services listed are not available in all countries. Some of the cars illustrated are equipped with optional features for which an extra charge is made. Details concerning the delivery specifications, appearance, performance, dimensions and weights, fuel consumption and running costs of the vehicle were correct to the best of our knowledge at the time of going to press. Deviations from the colours and shapes shown in the illustrations may occur. No liability is accepted for errors and printing errors. The right to introduce modifications is reserved. Not to be reproduced, including in part, without the written approval of AUDI AG.

This brochure is printed on paper made from pulp bleached without the use of chlorine.

