



A3

Audi A3 | A3 Sportback
Audi S3

Vorsprung durch Technik 



Fascination

- 4 Audi A3/A3 Sportback
30 Audi S3

Technology

- 44 Audi connect
46 MMI® – Multi Media Interface
48 Audi efficiency
50 Audi ultra
52 TFSI®
54 TDI®
- 56 S tronic®
58 quattro®
60 Suspensions
62 Audi drive select
64 Assistance systems
66 LED headlights

Equipment

- 70 Equipment lines
74 Audi exclusive
76 S line
80 Audi design selection
84 Style guides
88 Paint finishes
90 Wheels/tyres
92 Seats/seat upholstery
98 Headlinings
- 99 Inlays
100 Lights and mirrors
101 Exterior equipment
103 Interior equipment
107 Infotainment
110 Assistance systems
111 Technology
113 Audi Extended Warranty

Other

- 114 Audi Genuine Accessories
118 Technical data
120 Dimensions
- 122 Index
128 The fascination of Audi

Dialogue: Audi QR codes

Experience Audi even more directly:
download a QR app to your smartphone
and then scan the QR code or follow
the given link in your browser.



The equipment for the vehicles illustrated in the Fascination section can be found on page 127.
The fuel consumption and CO₂ emission figures can be found from page 118 onwards.

Way ahead.

What would it be like if technology could be operated intuitively?
If purist design were to encounter innovative functionality?
If sportiness and progress were to become one?

We have found the answer: with the new Audi A3 and the new Audi A3 Sportback. The design speaks a unique language, the dynamism is impressive on every trip. And the interior combines aesthetics with intuitive functionality. Experience our lead in vehicles that are way ahead.

The fuel consumption and CO₂ emission figures can be found from page 118 onwards.

A3

Audi A3 | A3 Sportback







More attractively ahead.

The new Audi A3 and A3 Sportback are flatter, more masculine and more dynamic. The slim side is defined by the striking tornado line along the edge of the window and the dynamic line above the sills. Taut, sculptural areas where light and shadows meet give the vehicles a compact and muscular look.

The fuel consumption and CO₂ emission figures can be found from page 118 onwards.





The narrow headlights give the Audi A3 a determined, concentrated look. They are optionally available as xenon plus headlights with LED daytime running light strip and with a choice of adaptive light with variable headlight range control. The exterior mirrors are set on the door rails like on a sports car. The slim, divided rear lights, which are available in LED technology in combination with xenon plus, give the vehicle a sporty low and wide appearance. The integrated roof edge spoiler creates additional dynamism and sportiness at the rear.

The fuel consumption and CO₂ emission figures can be found from page 118 onwards.





More intuitively ahead.

Unmistakeably an Audi – and yet it feels different. Lighter. Clearer. More forward-looking. The cockpit is captivating at first sight thanks to its clear layout and ergonomics.

The central control unit: the optional MMI navigation plus with MMI touch – a touch-sensitive control panel integrated in the rotary/push-button control for intuitive operation. Amongst other things, it offers you a new and intelligent way of controlling the navigation and telephone functions by “writing” letters or numbers on the control panel with your finger. You can also operate the functions supported by Audi connect via your MMI touch. The slim 7-inch colour display, which pops up electrically, presents all the information in a new look and impressive clarity.

The optional Audi phone box is extremely practical. It connects your mobile phone with the vehicle’s roof aerial so that you can make phone calls without a mobile phone cradle.

The fuel consumption and CO₂ emission figures can be found from page 118 onwards.



If you want to experience the Audi A3 in action, scan this QR code using your smartphone. Or follow this link in your browser: www.audi.com/a3film







High quality and innovative design can be found in every detail. The horizontal architecture of the instrument panel emphasises the size of the interior, 3D inlays seem to embrace the driver.

The air vents with their jet design further accentuate the stylish interior. Their air flow can be adjusted to provide a concentrated stream of air or to distribute air evenly, all with variable levels of intensity. The optional deluxe automatic air conditioning in black panel look connects the floating cockpit to the centre console. Fine leather sport seats are available on request, and further emphasise the high-quality appearance of the interior.

The optional Bang & Olufsen Sound System is a special highlight: enjoy brilliant surround sound from a total of 14 loudspeakers. The exclusive loudspeaker covers with aluminium applications and LED lighting accentuating the front woofers convey a sense of perfect design.

The fuel consumption and CO₂ emission figures can be found from page 118 onwards.

The dynamic roof contour of the A3 Sportback design emphasises its sporty character, and the powerful rear gives it a confident stance despite its lightness. The combination of a longer wheelbase and short overhangs makes the A3 Sportback look longer and conveys a sense of elegant sportiness.

The fuel consumption and CO₂ emission figures can be found from page 118 onwards.



If you want to experience the Audi A3 Sportback in action, scan this QR code using your smartphone. Or follow this link in your browser: www.audi.com/a3sbfilm









More connectedly ahead.

The world on board: thanks to Audi connect your A3 or A3 Sportback keep in constant contact. All you need is the MMI navigation plus with MMI touch and Audi connect.

Experience a new and individual way of enjoying mobility with Audi connect. You can plan your journey at home using myAudi – the data are transmitted to your vehicle and are available to you there. Traffic flow information is updated about every three minutes, so that you can always keep an eye on how clear your route is. On the road, you can comfortably use highly detailed Google Earth images* and Google Maps Street View* for navigation – making your journey through a new city easier than ever before. And you can use the Facebook service integrated in the infotainment system to for instance let your friends know exactly where you are right now.

Navigation, entertainment, connectivity. Or, put another way, stay up to date and up to the minute – in a way tailored flexibly to you.

* Google and the Google logo are registered trademarks of Google Inc.

The fuel consumption and CO₂ emission figures can be found from page 118 onwards.



Comfortable seats and a generous amount of space characterise the rear. The rear bench seat can be split-folded 40:60 to increase the luggage space. With the rear bench seat folded down completely you have 1,100 litres of space available in the A3 or even 1,220 litres in the A3 Sportback. The height-adjustable loading floor, under which you can create a further storage compartment, provides even more functionality. And the almost flush loading sill area makes loading very easy.

The fuel consumption and CO₂ emission figures can be found from page 118 onwards.









More efficiently ahead.

The A3 and the A3 Sportback have been built using Audi ultra lightweight technology. The intelligent combination of different materials reduces vehicle weight despite increased requirements for comfort and vehicle electronics. In addition, all the engines feature as standard a start-stop system and a recuperation function to convert kinetic energy into usable electrical energy during braking. This allows a fuel saving of up to 3 %.

Other optional intelligent helpers to make the vehicles even more efficient: the deluxe automatic air conditioning with eco mode, the onboard computer with efficiency program and the efficiency mode included in Audi drive select. The innovative thermal management also contributes to increasing efficiency. This networked system distributes heat between the engine, transmission and passenger cell as necessary.

The fuel consumption and CO₂ emission figures can be found from page 118 onwards.



More powerfully ahead.

The A3 and A3 Sportback have a choice of TFSI and TDI engines which take you dynamically and efficiently to your destination. Great emphasis is also placed on comfort and convenience. The optional dual-clutch transmission S tronic allows gear changes with virtually no perceptible interruption in power flow. As an alternative to front-wheel drive, the vehicles are also optionally available with quattro* permanent all-wheel drive. This guarantees better traction and even more superior handling.

* For information on when this feature will be available for the A3 Sportback, please contact your Audi partner.

The fuel consumption and CO₂ emission figures can be found from page 118 onwards.





More intelligently ahead.

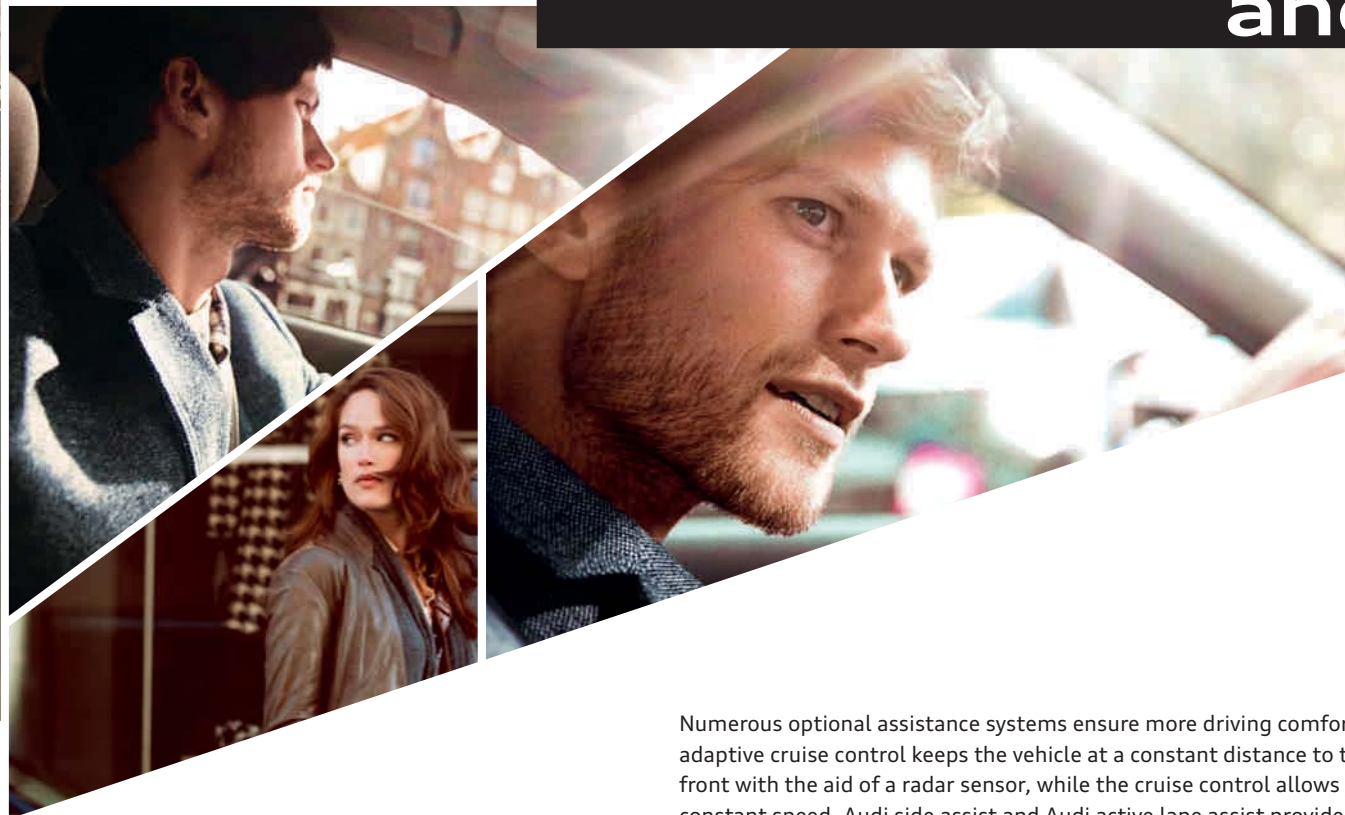

Numerous optional assistance systems ensure more driving comfort and safety. adaptive cruise control keeps the vehicle at a constant distance to the vehicle in front with the aid of a radar sensor, while the cruise control allows you to keep a constant speed. Audi side assist and Audi active lane assist provide support with lane changing or keeping to the lane. Various optional parking systems improve your field of vision and make it easier for you to park.

With Audi drive select, which is standard in the Ambition equipment line, you can set your vehicle to be either sporty or comfortable – you have up to five modes to choose from. The optional Audi magnetic ride allows the suspension tuning to be influenced as well.

The fuel consumption and CO₂ emission figures can be found from page 118 onwards.



How to turn an exclusive vehicle into a customised one: the three equipment lines Attraction, Ambition and Ambiente give your A3 or A3 Sportback a special character before they even leave the factory. Attraction emphasises the functionality of the vehicle, Ambition its sportiness, while Ambiente focuses on comfort. Also available on request: the large panoramic glass sunroof that can be both tilted and fully opened, allowing the interior to be flooded with light.

The fuel consumption and CO₂ emission figures can be found from page 118 onwards.







More flexibly ahead.

The Audi A3 and the A3 Sportback are so many things: intuitive, efficient, dynamic, networked. But they are one thing above all: way ahead. Enjoy your lead.

The fuel consumption and CO₂ emission figures can be found from page 118 onwards.

More dynamically ahead.

The new Audi S3: more power, more sportiness, more driving enjoyment. Get in and discover a whole new world.

The fuel consumption and CO₂ emission figures can be found from page 118 onwards.

S3

Audi S3







D IN S 3003

The Audi ultra lightweight design keeps the weight of the Audi S3 to an impressively low level. And thanks to its combination with the powerful 2.0 TFSI engine with Audi valvelift system you can enjoy an outstandingly agile yet highly efficient ride. In conjunction with the dual-clutch transmission S tronic and quattro permanent all-wheel drive, 221 kW of power lets the S3 sprint from 0 to 100 km/h in only 5.1 seconds; the torque of 380 Nm ensures spontaneous power delivery.

Dynamics at the press of a button: you can adapt the character of your S3 to your individual wishes using the standard Audi drive select. The quattro drive distributes the power of the S3 to all four wheels, providing you with excellent directional stability and improved traction. And the optional Audi magnetic ride automatically adjusts to the prevailing driving situation – for even more dynamics or a sporty yet comfortable ride.

The fuel consumption and CO₂ emission figures can be found from page 118 onwards.







More fascinatedly ahead.

The exterior mirrors shine in aluminium look, the S badge gleams between the chrome-plated dual struts in the Singleframe in S geometry. The optional full-LED headlights*, the S design of the side air intakes as well as the effective black painted brake callipers of the ventilated 17-inch brakes underline the pure sportiness of the Audi S3.

*For information on when this feature will be available, please contact your Audi partner.

The fuel consumption and CO₂ emission figures can be found from page 118 onwards.





Powerful sportiness defines the interior, too: the optional flat-bottomed leather-covered multifunction sport steering wheel with S badge and contrasting stitching, the S gear lever knob, the S-specific start-stop button and the pedals made of brushed stainless steel. The instrument cluster with grey dials integrates the turbocharger's charging pressure display, which allows you to access maximum engine power, particularly in conjunction with the aluminium shift paddles of the S tronic version. The optional S sport seats made of sumptuous fine Nappa leather with shoulder inserts in diamond-patterned stitching and integrated head restraints provide outstanding lateral support.

The fuel consumption and CO₂ emission figures can be found from page 118 onwards.





The side sills follow the design of the front apron and add even more sporty promise to the vehicle; the rear diffuser with the S-specific dual-branch exhaust system with two oval tailpipe trims help accentuate its impressive width. The striking roof edge spoiler makes the vehicle hug the road and puts the finishing touch to the striking rear.

The fuel consumption and CO₂ emission figures can be found from page 118 onwards.







More assuredly ahead.

Fascinating dynamics, impressive design – and always in touch with the rest of the world at the same time. A new definition of customised, networked sportiness. The new Audi S3.

The fuel consumption and CO₂ emission figures can be found from page 118 onwards.



If you want to experience the Audi S3 in action, scan this QR code using your smartphone. Or follow this link in your browser: www.audi.com/s3film



Way ahead.

Be permanently connected – via a mobile device using the vehicle's own Wi-Fi hotspot at a standstill or in the rear during driving. All the highlights at your current location or at any other destination at a glance – thanks to the city event service supported by Audi connect. Never miss any news ever again – access to Facebook and Twitter in conjunction with the text-to-speech function means you can always keep up to date, even while driving. Want to head for your favourite place again? This is now even easier thanks to picture book navigation. Find out more about the fascinating functions provided by the optional services supported by Audi connect on the following pages.



Networked mobility with Audi connect – in the Audi A3, A3 Sportback and S3. For car driving like you have never experienced before.

The fuel consumption and CO₂ emission figures can be found from page 118 onwards.



Audi connect:

The intelligent connection between the internet, the vehicle and you.

The world is a network – and your Audi is part of it. Audi connect not only brings the internet into your vehicle, it also exploits the possibilities that your smartphone, tablet or laptop provide.

In future, Audi connect will also make it possible to exchange data between vehicles as well as between vehicle and infrastructure. For even more driving pleasure and comfort.

With Audi connect you can use the optional MMI navigation plus with MMI touch to easily search the internet for special destinations, as well as get the current weather forecast for your intended navigation destination or the latest

news. Data is transferred via the UMTS module of Audi connect, which can be ordered in addition to the MMI navigation plus with MMI touch.

Audi connect also offers you wireless internet access via a Wi-Fi hotspot. During the ride, passengers can retrieve information and e-mails or surf the internet using their mobile device. There is an application for Audi music stream available for some smartphones.

The password-protected section of the myAudi platform offers you a range of personalised services and is your “control centre” for Audi

connect. Following once-only registration, you can use it to manage, clear and even partly configure the services supported by Audi connect conveniently, quickly and easily.

Further detailed notes about availability and legal information about Audi connect, the technical requirements (mobile phone contract, registration), any costs which may be incurred and the respective conditions of use can be found on page 109 of this catalogue and at www.audi.com/myAudi. Please contact your Audi partner for information about availability and scope of the services supported by Audi connect.



If you want to experience the full diversity of Audi connect, scan this QR code using your smartphone. Or follow this link in your browser: www.audi.com/audiconnecta3



Audi music stream
Access to global radio stations via smartphone app and Wi-Fi connection



Point-of-interest search
including voice control



Navigation with Google Earth images* and Google Maps Street View*



Exploration with Google Maps Street View*



myAudi – your personal “control centre” for Audi connect
Manage, clear and even partly configure services; and enter navigation destinations via myAudi



E-mails
can be read out from your mobile phone by voice output



News online
Text and images about current world events, can be configured individually



City events
Information about current events



Flight and train information
Convenient inquiry of departure times



Fuel stop
The cheapest service stations in the vicinity



Picture book navigation
Your pictures' GPS data guide you to the destination



Access to Facebook and Twitter
with text-to-speech function



Traffic information online
Detailed information on traffic flows, e.g. for individual stretches of road; faster information on the occurrence and clearing of traffic jams



Travel information
The latest travel tips and diagrams from the internet for the route chosen



Wi-Fi hotspot



Weather
Forecasts and maps for the required destination

* Google and the Google logo are registered trademarks of Google Inc.



MMI touch: You can “write” with your finger on the optional MMI touch. The system recognises letters and numbers. It can be used for navigation and for your phone; additionally you can browse through the albums in your music collection on the jukebox with a brief flick of the finger.



Car: This function allows the direct control of driver assistance systems, vehicle settings, climate control and service functions from MMI radio upwards.



Audi connect: Access to Facebook and Twitter

The social media services Facebook and Twitter are integrated into the infotainment. A text-to-speech function is particularly convenient. In addition, you can also use a practical text function with prepared text modules combined with vehicle data such as the current position.



Follow your intuition.

And you'll get there.

We try to match up to our claim of “Vorsprung durch Technik” in every aspect of an Audi – for example with the advanced optional MMI – Multi Media Interface. The MMI is used to control a wide variety of media in the vehicle, as well as the navigation system and other convenience functions. In addition, you can use it to control the optional services supported by Audi connect.

It used to be simple to operate the MMI – now it's even simpler. A reduced number of buttons brings greater clarity. Two innovative toggle

switches for radio and media as well as telephone and navigation or vehicle and sound allow you to change quickly between the different MMI functions from MMI radio upwards, and the four control soft keys are logically arranged near the central rotary/push-button control – for intuitive operation.

The volume control and its integrated skip function lets you switch more quickly between radio stations, for example. Another new feature is the carousel layout in the MMI display. The slim

5.8 or 7-inch colour display, which pops up electrically, presents all the information in a new look and with impressive clarity.

The special thing about the optional MMI navigation plus with 7-inch display is the MMI touch – a touch-sensitive control panel in the rotary/push-button control for intuitive operation of the MMI. It offers you, among other things, a new and intelligent way of controlling the navigation functions – by “writing” letters or numbers on the control panel with your finger.

The system acknowledges your input after each character by means of audible feedback. You can also browse through the albums in your music collection on the jukebox – a flick of the finger is all it takes.



Audi connect: Audi music stream

Using the Audi music stream app (not available for all smartphones) you can connect your mobile with the optional MMI navigation plus with MMI touch via Wi-Fi to access a comprehensive range of global radio stations. The stations can also be selected according to music taste or free text search and quickly retrieved once stored as favourites on your smartphone. Operation is convenient thanks to integration into MMI navigation plus with MMI touch. In addition, you have wireless access to the music stored locally on your smartphone via the MMI.



Audi connect: News online (customised)

Thanks to Audi connect you can keep up to date with the news even when on the road – with text and images about current world events from renowned national and international editorial teams. The news sources (RSS feeds) can be configured conveniently via www.audi.com/myAudi and played using the text-to-speech function during the journey. This allows you to tailor the news received to your individual interests. As an option, the extensive text can be displayed in the MMI when the vehicle is at a standstill.



Audi connect: Traffic information online

You not only get the right route to your destination but the quickest one too. In addition to traffic flow information, traffic information online provides faster information on the occurrence and clearing of traffic jams for dynamic route guidance as well as greater coverage of the road network (e.g. including trunk roads and rural routes).

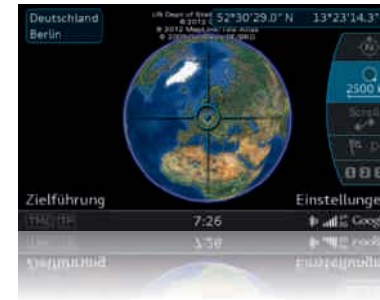

Audi connect: Navigation with Google Earth images* and Google Maps Street View* enables navigation with high-resolution aerial and satellite images, photographs, topographical features, roads and their designations, and business entries. Google Maps Street View* gives you a true-to-life picture of your destination even before you get there. You can access detailed information on places to visit using the **point-of-interest (POI) search function** with voice control. **Destination input by means of myAudi or Google Maps*** enables you to plan your route on your home computer with individual navigation destinations, and then send it to the vehicle. When you start your journey, the route plan is loaded into the optional MMI navigation plus with MMI touch.

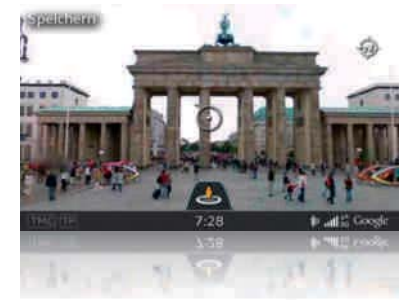

* Google and the Google logo are registered trademarks of Google Inc.

Your Audi also bears our mark of special efficiency.

Our vehicles embody not only sportiness, progress and technical innovations, but also the intelligent use of resources.

One example: the TDI engines with common rail technology. Their combination of direct injection and turbocharging guarantees highly efficient diesel fuel combustion. The TFSI engines work according to the same principle and are equally impressive thanks to increased power and torque coupled with reduced consumption. Audi engines have been subject to an ongoing development

process for years. This means that today, they are more powerful than ever before – despite reduced overall weight and thus reduced consumption. Impressive proof of our strategy of obtaining more power from less engine displacement. The start-stop system and recuperation also guarantee more efficiency.

The dual-clutch transmission S tronic makes ideal use of the high-torque Audi engines: its large transmission-ratio spread allows it to accelerate strongly even at low engine speeds;

this reduces fuel consumption. The Audi drive select efficiency mode and the Audi ultra lightweight design help you to tap additional savings potential.

You see, the Audi A3 models feature a whole range of technologies that will make your journey not only more comfortable and dynamic, but more efficient, too. Find out more on the next few pages.

The fuel consumption and CO₂ emission figures can be found from page 118 onwards.





Audi ultra on the podium: the Audi R18 ultra

Audi ultra:

Every gram less extends the lead.

Audi ultra, the pioneering lightweight technology from Audi, is more than just the sum of its individual components. It combines innovative materials, intelligent design principles and production processes that use resources sparingly into an overall concept. Many Audi ultra lightweight measures have already been implemented in the A3 models.

That starts with the body. The steel shell design of the vehicle combines low weight with high rigidity. Which type of material is used in which place on the vehicle is determined by the desired

characteristics. The resulting material mix of hot- and cold-formed metal panels and profiles in the vehicle body create an ultra-modern lightweight structure. But not only ultra high-strength steels are employed, light aluminium is also used to reduce the weight of attachment parts such as the bonnet and wings. The aluminium components on the front axle and the aluminium alloy wheels not only reduce the overall weight but also the unsprung masses, which in turn leads to a further increase in agility and driving comfort.

Drive technologies such as direct fuel injection and turbocharging have always made Audi engines more powerful. Modern TDI and TFSI engines produce more power with a smaller engine size, making them lighter than the corresponding engines used in earlier model series.

Each lightweight component has an effect on other components, allowing their dimensions to be reduced as well. Here, the lightweight body and lighter engines lead to secondary effects throughout the vehicle. The weight of many parts

of the exhaust system, suspension and interior has been able to be reduced. This complete package of measures for the A3 models saved up to 90 kg compared with the predecessor models.

The result of the Audi ultra measures is a continuous development process towards less and less weight and more and more efficiency.

The demands placed on modern vehicles are **contradictory**. On the one hand, they must offer enhanced performance and comfort, on the other they need to be more economical and efficient. Audi ultra resolves this conflict by examining each and every component. We demand the highest functionality combined with the lowest possible weight. The result is an intelligent mix of materials that even allows a reduction in engine size: lighter vehicles no longer need a large engine to be agile. In 2012, for instance, the two Audi R18 e-tron quattros and the Audi R18 ultra that drove to podium finishes at Le Mans had V6 engines, whereas their victorious predecessor in 2010, the Audi R15 TDI, had featured a V10 engine.

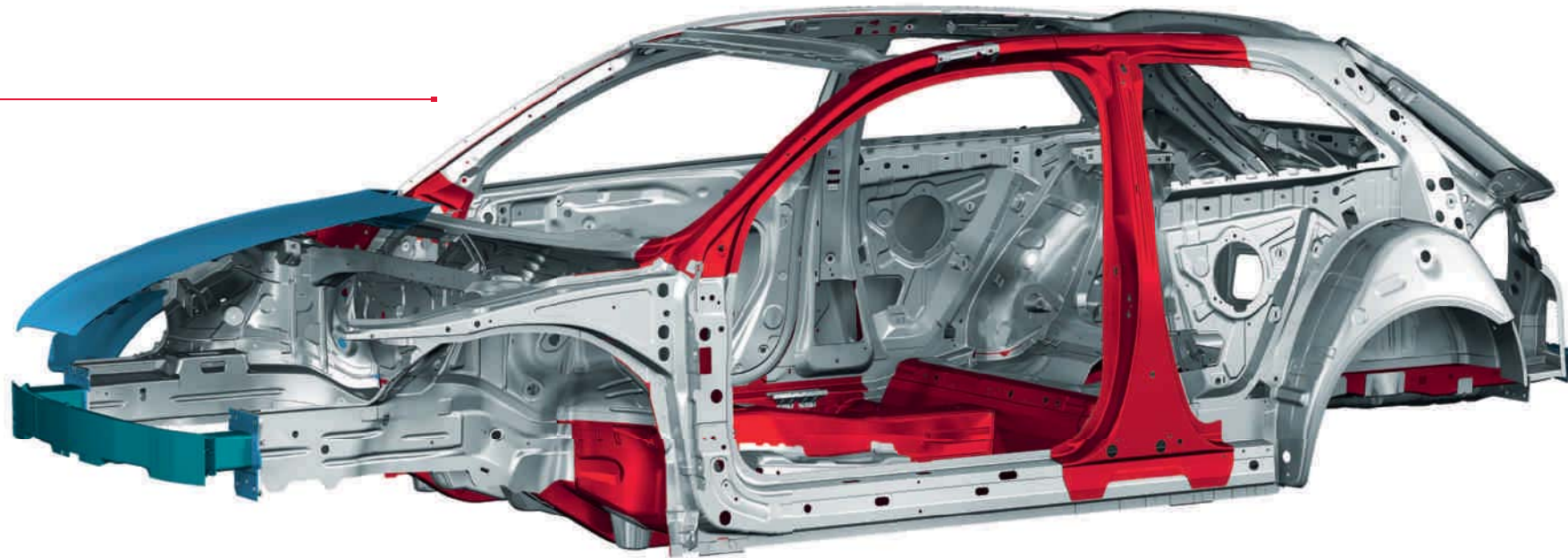

The image shows the Audi A3.

- Aluminium sheet
- Aluminium profile
- Hot-formed steel
- Cold-formed steel



- friction-reduced engine
- cast steel turbocharger
- cylinder head with integrated exhaust-gas cooling
- Audi valvelift system

Many hours of development time.
Thousands of miles of testing.
And for what reason?

1.8 TFSI engine (132 kW)

Engine power curve 2.0 TFSI quattro (221 kW) in the Audi S3

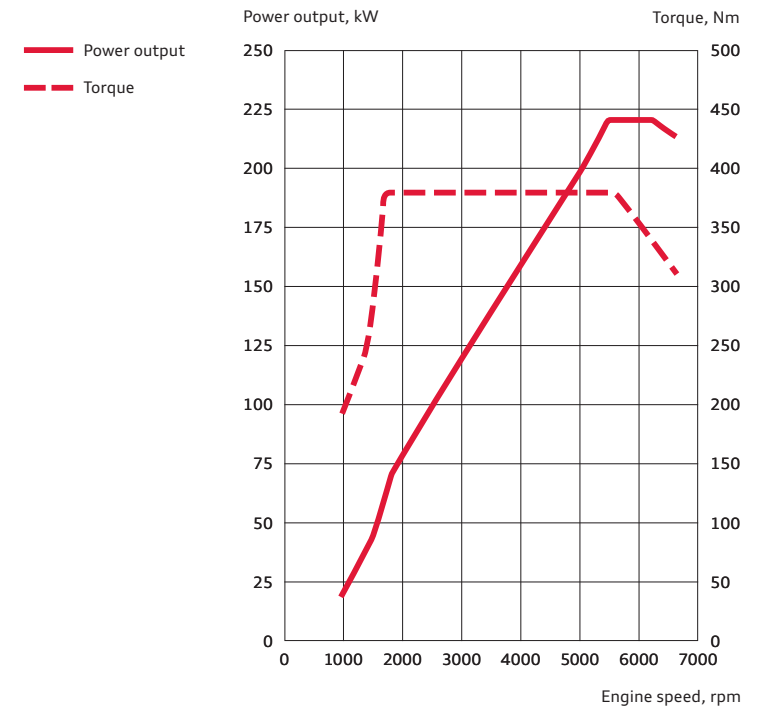

In just a few seconds you will understand why.

In FSI® technology, the fuel is injected directly into the combustion chamber and atomised into a fine spray. This way, the fuel – metered to almost droplet precision – can be called upon the millisecond that the engine requires it. This can contribute to better use of the fuel and thus to reduced fuel consumption.

The A3 models employ TFSI technology. This combines the advantages of FSI – efficiency and dynamism – with a turbocharger, which ensures even better power delivery. The 1.4 TFSI engine with 90 kW in the A3 and A3 Sportback will get

you economically yet powerfully to your destination. Its lightweight aluminium engine block saves weight and allows you to reduce fuel consumption.

The 1.8 TFSI engine with 132 kW in the A3 and A3 Sportback works with the Audi valvelift system and intelligent thermal management. More torque is generated at low engine speed by switching between two exhaust cam contours. You feel the effect directly: the engine reacts more quickly and accelerates with S tronic from 0 to 100 km/h in 7.2 seconds in the A3 and in

7.3 seconds in the A3 Sportback. The Audi valvelift system also helps you to save fuel and reduce CO₂ emissions. In addition to direct fuel injection, the 1.8 TFSI (132 kW) uses indirect injection, which makes the part load range even more efficient.

The turbochargers of both engines have an electric wastegate actuator which regulates the charging pressure particularly quickly and precisely. In addition, the exhaust manifold has been integrated in the water-cooled cylinder head, shortening the engine warm-up period and reducing the exhaust gas temperature. All these

measures help to reduce consumption, particularly with a sporty driving style. It goes without saying that both engines comply with the EU5 emission standard.

The 2.0 TFSI engine in the Audi S3 even meets the stringent requirements of the EU6 emission standard. Its 221 kW power it with S tronic from 0 to 100 km/h in 5.1 seconds. This engine also works with the Audi valvelift system, as you will notice through the direct, agile response. And the integrated exhaust manifold saves space and also helps reduce consumption.



The injectors open and close in fractions of a millisecond and inject fuel several times into the combustion chamber at pressures of up to 1,800 bar. In some cases, an injection process can involve the injection of the tiniest of amounts weighing less than a thousandth of a gramme.



Pre-injection results in a “gentle” combustion process and consequently excellent combustion acoustics and agreeable engine running characteristics.

TDI®

In other words: Where is the tank?

Almost one in every two Audi cars sold today is a diesel. What sounds perfectly normal now was cause for huge excitement a good 20 years ago, when Audi revolutionised the market with the first 2.5 litre TDI engine. Developments in technology such as common rail technology have since made TDI more and more efficient. The injectors ensure the fuel is finely and precisely distributed. Consequently, since the first TDI, the engines have become more economical, whilst specific output has increased. That's why it was only logical for a diesel to enter the world of

motorsport. And successfully too: in 2006, Audi was the first car maker to win the Le Mans 24 Hours with a diesel-powered race car, the Audi R10 TDI – and then went on to repeat this victory several times over, most recently in 2012.

The diesel engines in the A3 and A3 Sportback will leave you enthralled not only by their engine power but by their efficiency as well. Their common rail injection system has four injectors and is characterised by an excellent balance of performance, driving comfort and engine acoustics.

The 1.6 TDI with 77 kW produces 250 Nm of torque and lets you accelerate the Audi A3 with manual transmission from 0 to 100 km/h in 10.7 seconds. Yet it only consumes an impressive average of 3.8 l of fuel over 100 km and has a combined emission of only 99 g CO₂/km.

The 2.0 TDI with 110 kW and manual transmission produces 0 to 100 km/h times of 8.6 seconds for the A3 and 8.7 seconds for the A3 Sportback. It also has a highly efficient thermal management system. Its two balancer

shafts are now directly integrated in the crankcase, improving the running smoothness even further. It reaches its maximum torque of 320 Nm at 1,750 rpm. The engine with manual transmission consumes an average of 4.1 l/100 km in the A3 and 4.2 l/100 km in the A3 Sportback, and emits only 106 g CO₂/km in the A3 and 108 g CO₂/km in the A3 Sportback (combined values).

The fuel consumption and CO₂ emission figures can be found from page 118 onwards.

turbocharger with adjustable turbine geometry

friction-reduced engine

1,800 bar high-pressure injection system



balancer shafts

2.0 TDI engine (110 kW)

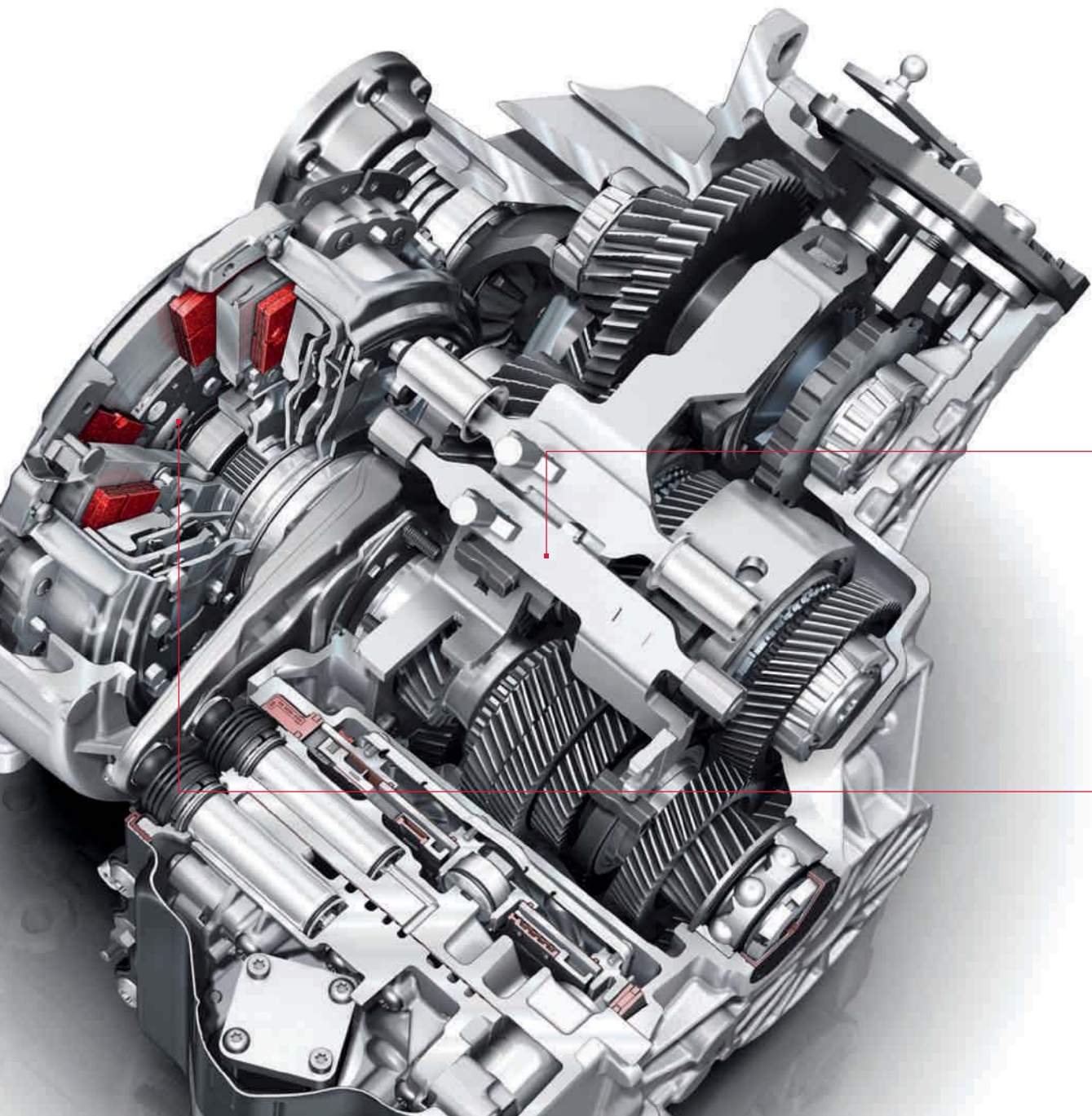

S tronic: 2 single-plate clutches provide for a sporty dynamism and high efficiency.

What is the benefit of two clutches?

A double saving: time and energy.

The dual-clutch transmission S tronic enables quick gear changes with hardly any perceptible break in propulsive power and is therefore particularly efficient.

As long ago as 1985, Walter Röhrl tested this technology in the Sport quattro S1 – and was suitably impressed. Audi drivers share his enthusiasm to this day, because the modern S tronic changes gear in a flash. To do this, two single-plate clutches serve the different gears. One clutch transfers the torque via a solid drive shaft to the gearwheels of the odd-numbered gears. A second clutch serves the even-numbered gears

via a hollow shaft. Both parts of the transmission are permanently active, but there is only ever one actively connected to the engine via the closed clutch. For example, if the vehicle is accelerating in third gear, then the second part of the transmission is already engaged in fourth gear. The gear change happens very quickly through the change of clutches – the first clutch opens, whilst the second one closes. This takes only a few hundredths of a second and is completed with virtually no interruption in the power flow. It runs so smoothly and comfortably that the driver barely notices it.

It doesn't matter whether the driver chooses the fully automatic modes with the program D (Drive) or S (Sport) or changes gear manually with the selector lever or the optional shift paddles on the steering wheel – the gear change feels precise and extremely sporty. Even with all of this dynamic technology, the S tronic still remains efficient. Its high level of efficiency helps to reduce both fuel consumption and emissions.

The fuel consumption and CO₂ emission figures can be found from page 118 onwards.



Why only use two wheels when a car has four?

The quattro® permanent all-wheel drive.

Those who know Audi know quattro*. And once you have driven with quattro, you do not want to drive with anything else. Why? Because this drive brings engine power to the road in such a convincing way.

quattro is a permanent all-wheel drive. If the wheels on one axle of the vehicle lose grip on the road and threaten to spin, the wheel-selective torque distribution transfers the drive force

through the transfer gear box and the Haldex clutch to the axle or individual wheel with the better grip. The benefit is better traction and thus improved acceleration as well as more safety thanks to more balanced lateral guide forces.

But what makes quattro special is really the driving feel. "As if you're stuck to the road," some customers say. We put it like this: quattro gives you a better feel for the road and thus more safety.

* For information on when this feature will be available for the A3 Sportback, please contact your Audi partner.

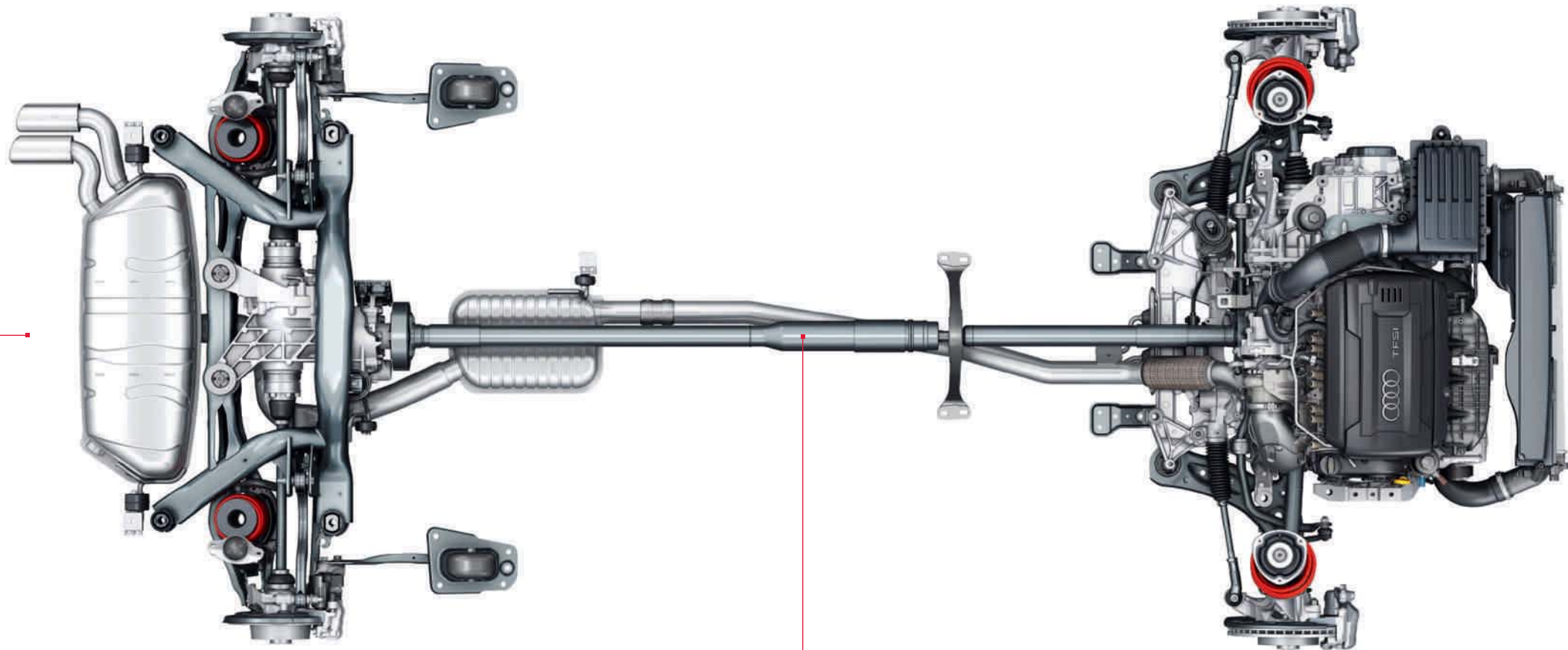

The quattro drivetrain

Dynamic. Comfortable. Superior.

Your suspension shows plenty of character.

The dynamic suspension in the Audi A3 and A3 Sportback unites sporty agility and outstanding tracking stability with a high level of comfort when driving. The springs and dampers of the McPherson front axle react immediately to the requirements of the road. The direct steering ratio provides a spontaneous response to movements of the steering wheel and the electromechanical power steering ensures the steering assistance is matched to your driving speed.

With the sport suspension, which is standard for the Ambition equipment line, the vehicle is

lowered by about 15 mm, providing even more sportiness combined with a high level of driving comfort. The S sport suspension, standard in the S3, and the S line sport suspension, optionally available for the A3 and A3 Sportback, have more dynamic spring/damper tuning and put you another 10 mm closer to the road. The progressive steering standard in the S3 further increases driving dynamics through a direct and progressive steering ratio.

The adaptive damper system Audi magnetic ride, which is available on request, is a very special way of moving both sportily and in comfort. The

system quickly adjusts the stiffness of the dampers to the road conditions. Instead of a conventional damper oil, Audi magnetic ride uses a special fluid whose flow behaviour can be changed by an electromagnetic field. The driver can select one of three basic settings. In the comfort mode, the Audi magnetic ride is a comfortable suspension which enables relaxed driving even on long journeys. In the sport mode, the suspension transmits direct feedback from the road; the vehicle reacts with even more agility. And in automatic mode, the vehicle adapts to the respective driving situation.



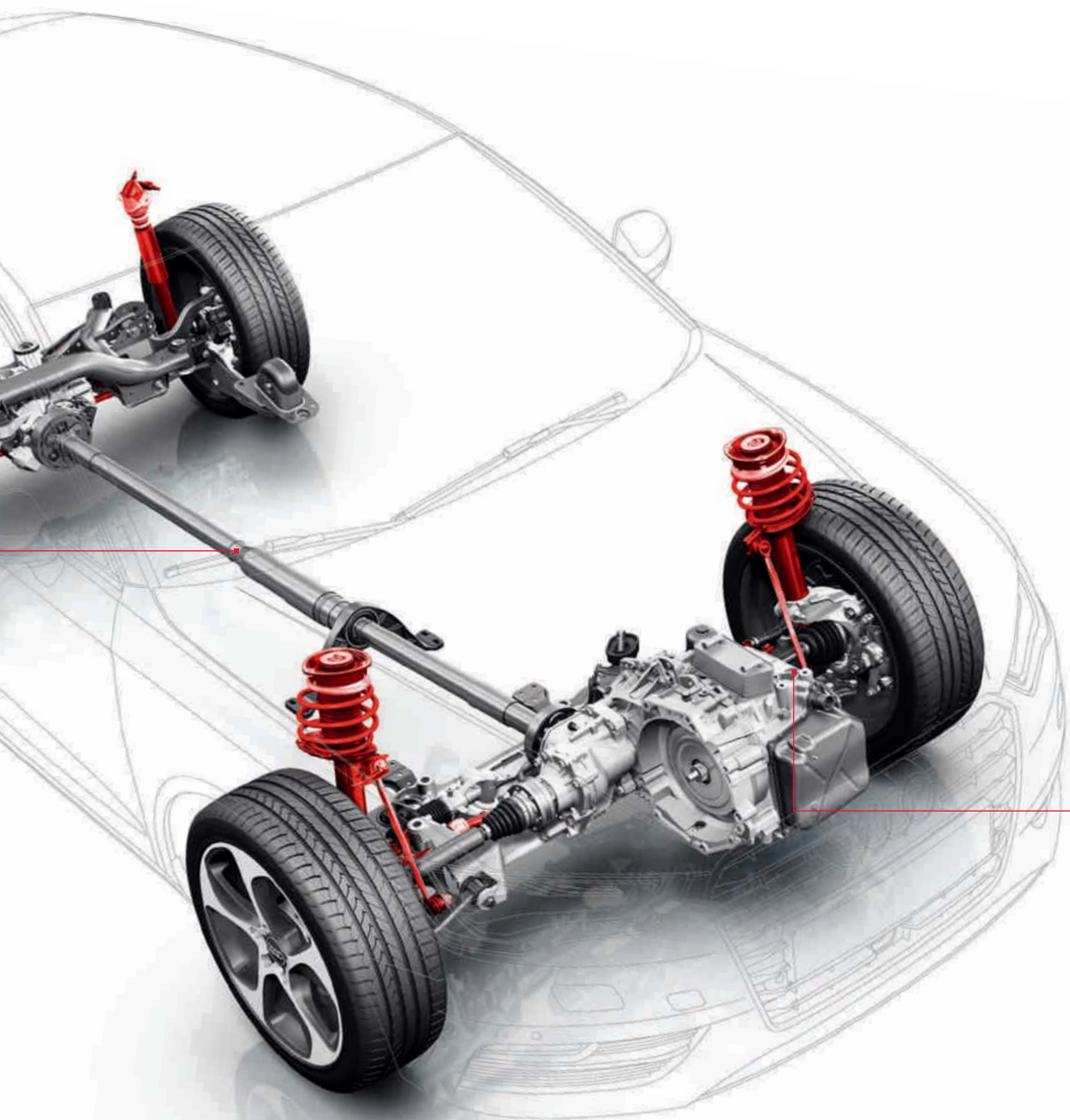

The sport suspension, with body lowered by 15 mm, stiffer springs and damper tuning for more direct contact with the road and sporty handling, in combination with the optional adaptive damper system Audi magnetic ride with individual selection of suspension tuning

Why do the Audi A3 models suit you so well?
Because they adapt themselves to you so well.

Audi drive select.



comfort



dynamic



auto



efficiency



individual

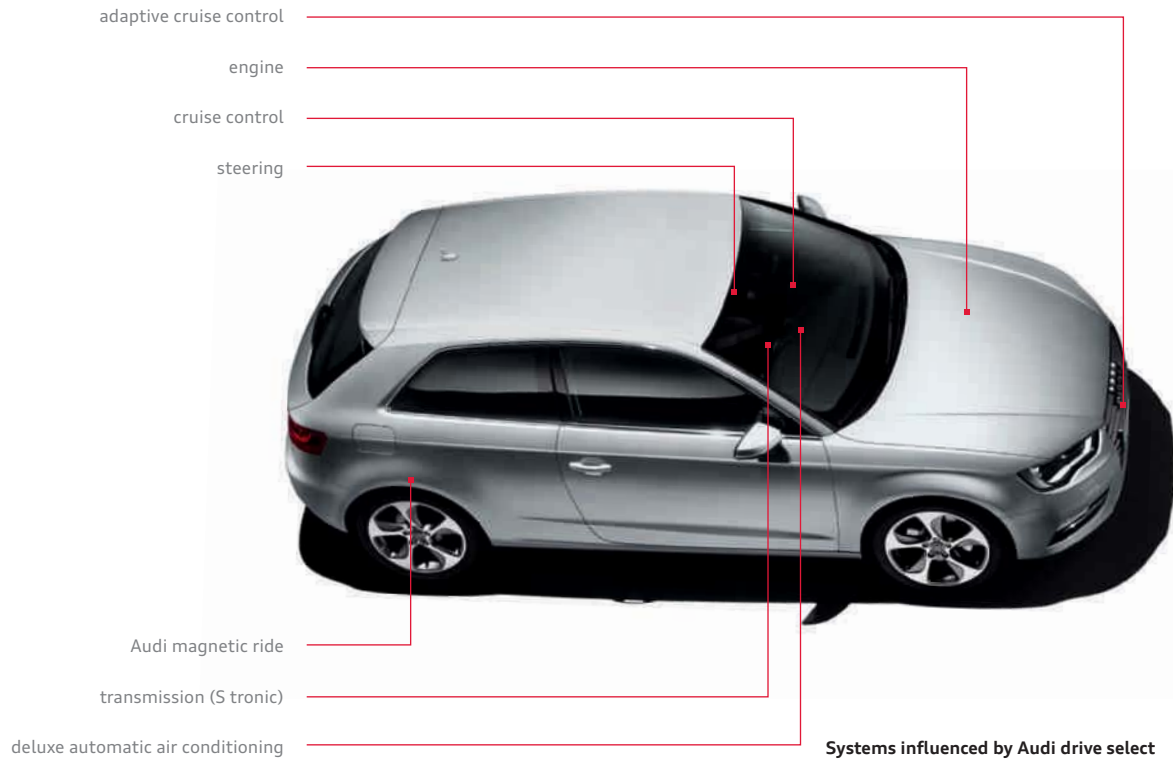

Everybody defines driving dynamics differently. We define it like this: drive exactly how you feel.

With Audi drive select, which is standard in the Audi S3 and the Ambition equipment line, you can influence individual vehicle components at the push of a button or via the car menu in the optional MMI and so change the character of your Audi. You have up to five modes to choose from: efficiency, comfort, dynamic, auto and – in conjunction with MMI radio or MMI navigation

plus with MMI touch – individual. In this mode, you determine the behaviour of the connected vehicle components yourself.

The comfort mode is especially suitable for providing the most relaxed driving possible on long journeys. The auto mode offers a generally comfortable yet sporty driving experience. For particularly sporty driving, for example on winding roads, there is the dynamic mode. The efficiency mode helps to improve consumption values. As

an integral part of Audi drive select, it is characterised with S tronic by a changed gear change program and more energy-efficient basic setting. When you take your foot off the accelerator, the vehicle automatically goes into coasting mode when set to efficiency, which means the vehicle continues idling without engine brake losses. In every mode, the vehicle adjustments depend on the equipment selected.

The fuel consumption and CO₂ emission figures can be found from page 118 onwards.

You sit at the wheel.

Others are working in the background.

Most road accidents are caused by human error. Modern assistance systems can help to reduce their severity. Audi puts various different technologies to work to help you reach your destination safely. The assistance systems are closely networked, which increases their versatility and performance. With the help of these systems, your journey will be safer and more relaxed.

On request, the A3 models can be equipped with something quite special, a sort of sixth sense – or Audi pre sense. A vehicle sensor categorises driving situations and initiates any necessary preventive passenger protection measures at critical moments, even as far as collision avoidance. The optional Audi pre sense basic includes various preventive passenger protection systems that are ac-

tivated in the event of a critical driving situation. These include tensioning of the front seat belts as well as closing of the windows and – if fitted – the panoramic glass sunroof. Audi pre sense front additionally monitors the traffic ahead via the radar sensor of the optional adaptive cruise control. The driver is warned of critical situations and the brake force is increased or, if the driver does not react, a braking action is initiated by the system.

To avoid critical situations to start with, the optional attention assist evaluates the driver's steering movements and pedal actuation, for example, at speeds of between 65 and 200 km/h. If these indicate decreasing driver attentiveness, the system recommends a break through a display in the driver information system and an acoustic signal.

In the event of a collision, many safety features are coordinated in the Audi A3, A3 Sportback and S3. The engine and fuel supply are stopped, the door locking mechanism is opened and the hazard lights and interior lighting are activated. What is more, the secondary collision brake assist prevents many instances of uncontrolled continued vehicle motion. Further safety functions include the high-strength passenger cell and the load-reducing design of the interior near the occupants.



adaptive cruise control including automatic full braking action:* The automatic distance control detects vehicles ahead by means of a radar sensor. Within system limits, the vehicle brakes and accelerates automatically, keeping a constant distance to the traffic ahead. If a collision threatens – for example in stop-and-go traffic or there is a danger of a traffic jam – adaptive cruise control can even bring your A3 model to a complete standstill at speeds under 30 km/h.

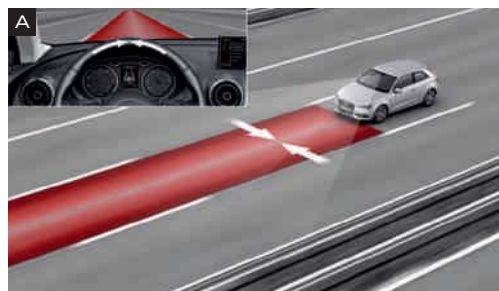

Audi active lane assist* with lane centre guide supports you when travelling at speeds of around 60 km/h or above up to a maximum speed of 250 km/h by a gentle corrective steering movement and warns you through steering wheel vibration if you leave your chosen lane unintentionally. In the MMI, you have the choice between 2 system settings (steering time if you leave [A] or late [B]). The **camera-based traffic sign recognition** is an optional additional function. This displays traffic signs showing a speed limit or overtaking ban clearly via the driver information system with colour display.

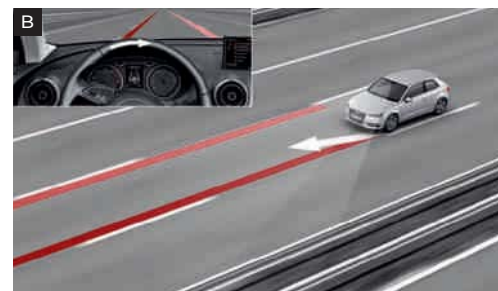



Audi side assist*: The lane change assistant helps you to change lanes more safely. From a speed of 30 km/h, it monitors the area alongside and behind the vehicle. Radar sensors detect other vehicles and warn you through an LED display in the exterior mirror if there is a vehicle in your blind spot.

The fuel consumption and CO₂ emission figures can be found from page 118 onwards.

Please note: The systems can only work within system limits. They can be of assistance, but drivers are still required to be attentive at all times.

*Optional equipment.

< 300 °C

Conventional light bulbs reach temperatures of up to 300 °C. LED lights, with their sophisticated technology, are somewhat more sensitive and should not get hotter than 150 °C. Because of the engine, the temperature of the area around the headlights is already around 120 °C. In theory, then, LED headlights would need an additional cooling system to be able to work. However, the Audi engineers did not want to spoil the good low-energy credentials of the LED headlights, so they developed a fan which directs heat away from the LED chips. The special feature of this fan is its additional benefit. The high operating temperature of standard bulbs means that they can defrost the headlights, which LEDs cannot. The newly developed fan, however, directs warm air from the LED chips directly to the headlight lens and thus defrosts them and prevents them from misting up.

Subject: Light

LED headlights



Daytime running light



Dipped beam



Indicator

Less energy, more light:

the Audi S3 with full-LED headlights.

Full-LED headlights* are available as an option for the Audi S3. The LED technology allows near daylight illumination of the road and stands out in comparison with conventional lighting due to its lower energy consumption and longer service life.

For the first time in the S3, the LED headlights bring together dipped beam, high beam and the combined daytime running light, position light and indicator function in a single light guide unit. The striking Audi light pattern in daytime and

night-time design gives the headlight a characteristic look.

The right lights in every situation: the turning light supplements illumination alongside the vehicle in tight bends and when turning corners.

The headlight also has a motorway light that automatically more than doubles the range of the light cone at speeds above approx. 110 km/h.

The headlight functions are rounded off by the

all-weather light which does away with the need for conventional fog lights. The individual LED modules are skilfully controlled to redistribute the light, reducing glare from fog, rain or snow.

The different headlight light distribution patterns town light, motorway light and country light are activated according to speed and can also be controlled using the stored route data of the optional MMI navigation plus with MMI touch. The junction light with a broad spread of

light from the front lighting system completes the convenient lighting assistant functions. The combination of all these measures results in a balanced light pattern and more comfortable driving for you.

* For information on when this feature will be available, please contact your Audi partner. The fuel consumption and CO₂ emission figures can be found from page 118 onwards.

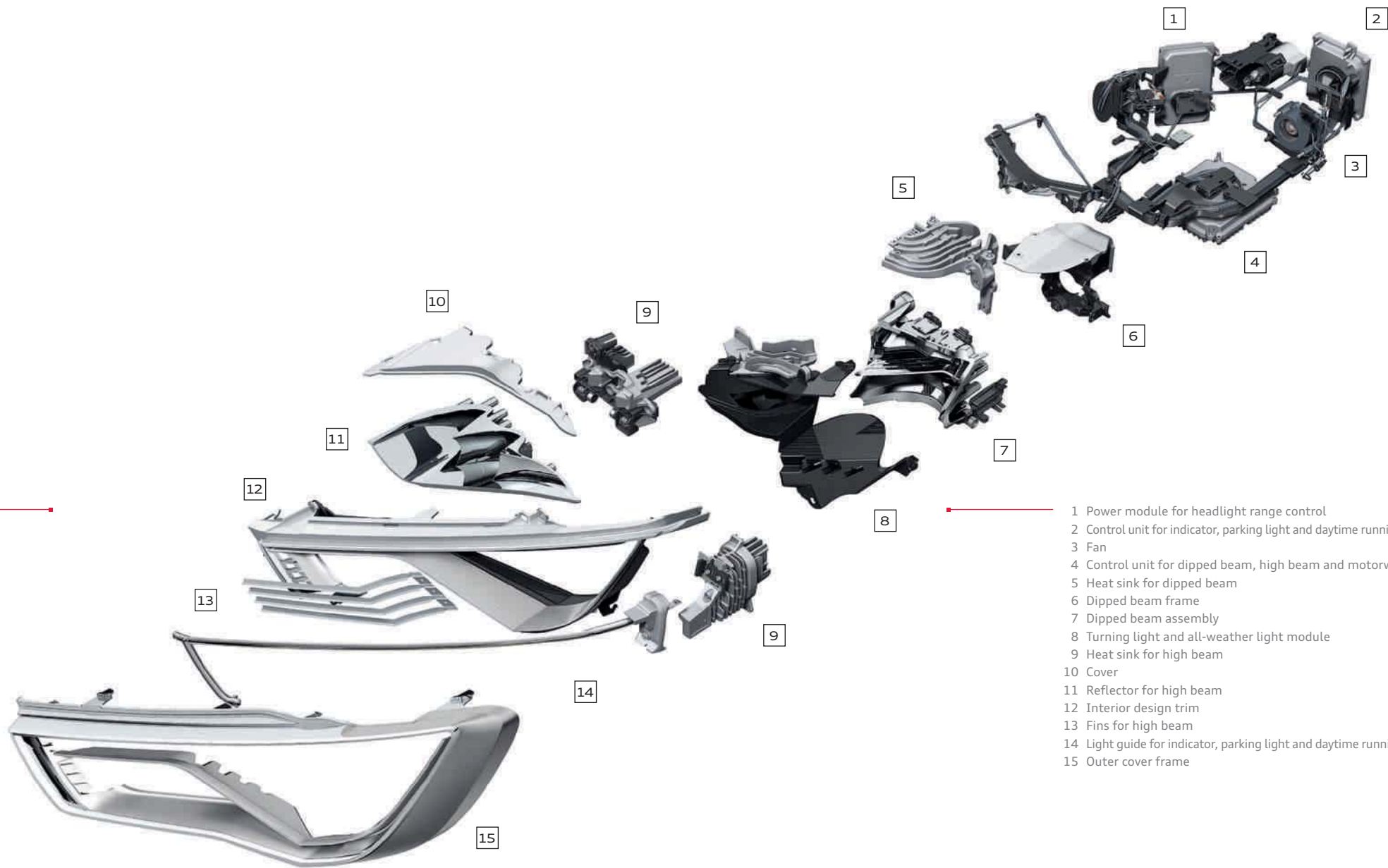

- 1 Power module for headlight range control
- 2 Control unit for indicator, parking light and daytime running light
- 3 Fan
- 4 Control unit for dipped beam, high beam and motorway light
- 5 Heat sink for dipped beam
- 6 Dipped beam frame
- 7 Dipped beam assembly
- 8 Turning light and all-weather light module
- 9 Heat sink for high beam
- 10 Cover
- 11 Reflector for high beam
- 12 Interior design trim
- 13 Fins for high beam
- 14 Light guide for indicator, parking light and daytime running light
- 15 Outer cover frame





It is the equipment that turns an Audi into your Audi.

Three equipment lines. One fascination.



Choose the Audi A3 or A3 Sportback that best suits your personality. There are three fascinating equipment lines available from the factory: Attraction, Ambition and Ambiente.

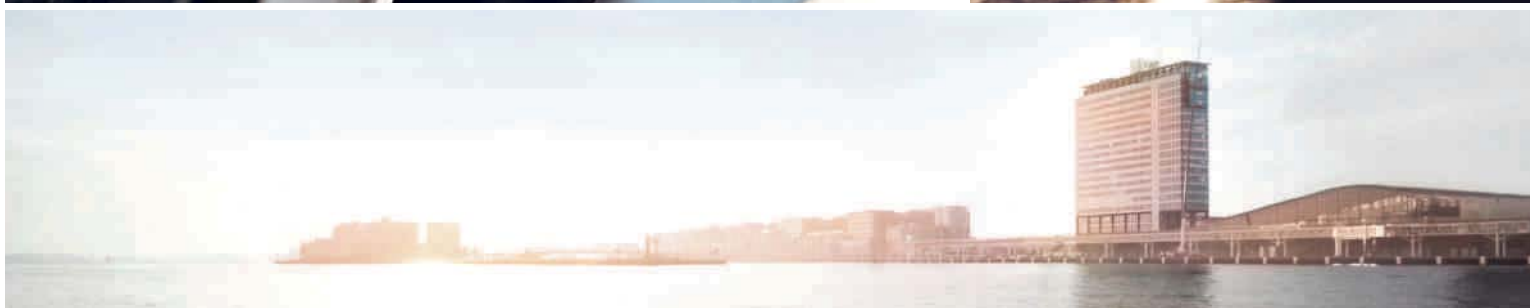

The fuel consumption and CO₂ emission figures can be found from page 118 onwards.

Attraction – character and emotions.



Attraction

Model-specific standard equipment

Interior distinguishing features:

inlays in micrometallic, silver, in the door trims and instrument panel

seat upholstery in marathon cloth

Exterior distinguishing features:

steel wheels with full wheel covers, size 6.5 J x 16 with 205/55 R 16 tyres

Functional distinguishing features:

steering wheel, padded, in 4-spoke design



The images show the Audi A3.

Ambition – sportiness and dynamics.

Ambition

Model-specific standard equipment

Interior distinguishing features:

inlays in micrometallic, silver, in the door trims and instrument panel

door sill trims with aluminium inlays on the door sills
seat upholstery in rallye cloth

Exterior distinguishing features:

cast aluminium wheels in 5-arm design, size 7.5 J x 17 with 225/45 R 17 tyres

chrome-plated trims for exhaust tailpipes, single or double tailpipe depending on engine variant

Functional distinguishing features:

sport seats, front

leather-covered sport steering wheel in 3-spoke design, includes gear or selector lever knob in leather

driver information system with colour display, including digital speed display and onboard computer with efficiency program

Audi drive select

front fog lights in halogen technology, integrated in the front apron

sport suspension, can also be ordered in conjunction with dynamic suspension



The fuel consumption and CO₂ emission figures can be found from page 118 onwards. The images show the Audi A3.

Ambiente – luxury and comfort.



Ambiente

Model-specific standard equipment

Interior distinguishing features:

inlays in 3D-design "Optic" in door trims and instrument panel

door sill trims in black

seat upholstery in regatta/mono.pur cloth

Exterior distinguishing features:

cast aluminium wheels in 15-spoke Y design, size 7 J x 16 with 205/55 R 16 tyres

High-gloss package

chrome-plated trims for exhaust tailpipes, single or double tailpipe depending on engine variant

Functional distinguishing features:

driver information system with colour display, including digital speed display and onboard computer with efficiency program

cruise control

leather-covered steering wheel in 4-spoke design, includes gear or selector lever knob in leather

centre armrest, front

lighting package

parking system, rear

The images show the Audi A3.

Audi exclusive

Exclusivity does not know the meaning of the word compromise. But it is familiar with endless variety.

Each year Audi sells hundreds of thousands of vehicles. Yet they only sell yours once. How is that possible? With a quattro GmbH service that makes your Audi unmistakable: Audi exclusive.

Combine selected woods, coloured leather and a customised paint finish from the large selection of colours available from Audi exclusive to suit your personal wishes. Your unique vehicle will be the result.

Your Audi partner and the Audi exclusive Studio of the Audi Forum Neckarsulm await your wishes.





Audi exclusive leather upholstery and trim in Alcantara/leather, alabaster white/powder beige with contrasting stitching in powder beige and Audi exclusive controls. From quattro GmbH. The image shows the Audi A3.

The fuel consumption and CO₂ emission figures can be found from page 118 onwards.

S line. Visibly more sportiness.

When you drive an Audi A3 or A3 Sportback, you are making a clear declaration of your belief in sporty motoring. The S line packages give you the opportunity to enhance the athletic presence of your Audi A3 or A3 Sportback: with a range of equipment that accentuates its dynamic lines, gives its interior a perceptibly sporty identity and further enhances its driving performance. Choose how to up the sportiness.



S line exterior package

Front and rear bumpers, side grilles and diffuser insert in a striking, sporty design

Radiator grille in high-gloss black

Diffuser insert painted in platinum grey

S line roof edge spoiler

Front fog lights

Front fog light surrounds in high-gloss black

Chrome-plated trims for exhaust tailpipes single or double tailpipe depending on engine variant

Door sill trims with aluminium insert and S line logo

S line logos on the front wings



Bumpers in a striking sporty design with accentuated side air inlets and radiator grille in high-gloss black



Diffuser insert painted in platinum grey with honeycomb design



Black interior with contrasting stitching, sport seats with seat upholstery in biathlon cloth/leather with S line embossing, inlays in matt brushed aluminium. The images show the Audi A3.



S line leather-covered sport steering wheel with contrasting stitching, steering wheel grips in perforated leather and S line emblem



Selector lever knob in perforated black leather



Cast aluminium wheels in 5-parallel-spoke design, partly polished

Seat upholstery

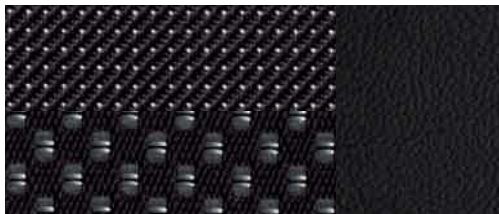

Biathlon cloth/leather, black



Perforated Alcantara/leather, black

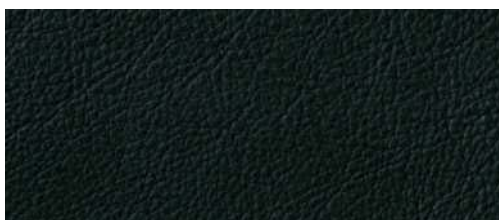

Fine Nappa leather, black

Inlays



Matt brushed aluminium

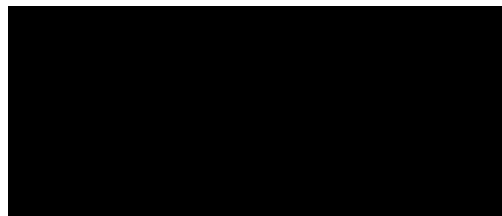

3D-design "Black"

S line sport package*

Cast aluminium wheels in 5-parallel-spoke design
partly polished, size 7.5 J x 18 with 225/40 R 18 tyres;
further wheels in 18 inch are available as an option.

S line sport suspension
with more dynamic spring/damper setting and vehicle
lowered by 10 mm compared with the sport suspension
or by 25 mm compared with the dynamic suspension;
optionally available: Audi magnetic ride

S line logos
on the front wings and door sill trims

Interior, dashboard and headlining
in black, contrasting stitching on seat upholstery,
leather-covered sport steering wheel and gear or
selector lever gaiter

S line inlays
matt brushed aluminium;
optional: 3D-design "Black"

Sport seats, front
optional: S sport seats, front

**S line leather-covered sport steering wheel
in 3-spoke design**
in black leather (steering wheel grips in perforated
leather) with contrasting stitching and S line emblem;
optional: S line leather-covered multifunction sport
steering wheel in 3-spoke design, flattened at the
bottom; models with S tronic optionally have shift
paddles behind the steering wheel – each in black
leather (steering wheel grips in perforated leather)
with S line emblem

Gear or selector lever knob
in perforated black leather

Storage and luggage compartment package

Illuminated vanity mirror

Seat upholstery in biathlon cloth/leather
in black, with S line embossing on the front-seat
backrests;
optional: S line seat upholstery in perforated Alcantara/
leather or fine Nappa leather (for front sport seats the
shoulder area is in velvet leather and for front S sport
seats in fine Nappa leather embroidered with contrast-
ing stitching), each in black with S line embossing in
the front-seat backrests

The following options are available for paint finishes:
all standard colours, additional colour option in the
special colour of Daytona grey, pearl effect available

Additional paint finish option



Daytona grey, pearl effect

Audi design selection Capri orange: stylish highlights.



The image shows the Audi A3.

The Audi design selection Capri orange*, available for the A3 and A3 Sportback, fulfils sophisticated expectations thanks to high-grade materials and exclusive equipment. The contrast between the colours black and Capri orange produces a sporty atmosphere. The front sport seats in Milano leather, black, and the steering wheel and gear or selector lever knob in leather convey both the look and feel of agility and dynamism. Velvet leather in Capri orange in the shoulder area of the sport seats and in the door mirrors is a striking eye-catcher. Specific details on the range of the equipment package can be found on page 98.

The fuel consumption and CO₂ emission figures can be found from page 118 onwards. * Only available for Ambition.



The images show the Audi A3.

Audi design selection parade red: perceptible athleticism.



The image shows the Audi S3.

High-quality dynamics that can be seen and felt in every detail define Audi design selection parade red, available exclusively for the Audi S3. The sport seats, front, are covered in sumptuous fine Nappa leather, black, with contrasting stitching in parade red, as are the kneepads and the door armrests. The door mirrors and the parade red shoulder inserts of the sport seats in velvet leather lend the vehicle a dynamic touch. Their striking colour is picked up by the contrasting stitching which can be found on the leather-covered sport steering wheel and on the gear or selector lever gaiter. Every single detail is impressive and is designed to enhance the sporty atmosphere inside the S3. Specific details on the range of the equipment package can be found on page 98.

The fuel consumption and CO₂ emission figures can be found from page 118 onwards.



The images show the Audi S3.



Audi A3 Ambition in scuba blue, metallic, with cast aluminium wheels in 5-arm kinetic design.
Equipment: sport seats in Milano leather, titanium grey, inlays in aluminium mistral,
Bang & Olufsen Sound System, aluminium look in the interior





Audi A3 Ambiente in glacier white, metallic, with cast aluminium wheels in 15-spoke design.
Equipment: standard seats in regatta cloth/mono.pur, chestnut brown, inlays in 3D-design "Optic",
Bang & Olufsen Sound System, aluminium look in the interior





Audi A3 Sportback Ambition in Misano red, pearl effect, with Audi exclusive cast aluminium wheels in 5-arm rotor design, black, and high-gloss turned finish.

Equipment: sport seats in rally cloth, black/silver, inlays in aluminium mistral





Audi A3 Sportback Ambiente in beluga brown, metallic, with cast aluminium wheels in 15-spoke Y design.
Equipment: standard seats in Milano leather, pashmina beige, inlays in 3D-design "Optic", extended interior elements in mono.pur





Beluga brown, metallic

Solid paint finishes

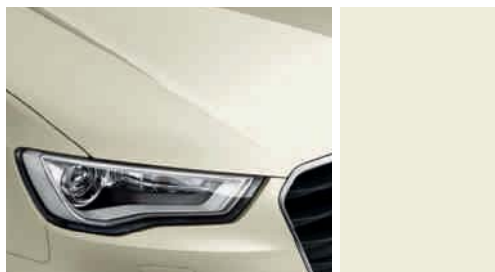

Amalfi white

Metallic paint finishes

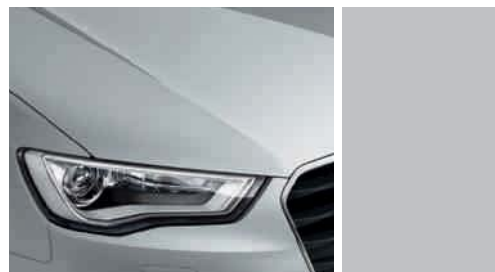

Ice silver, metallic



Brilliant red



Monsoon grey, metallic



Brilliant black

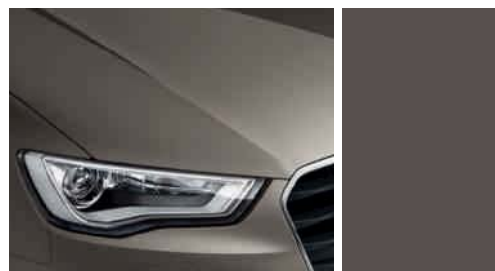

Dakota grey, metallic

Metallic paint finishes

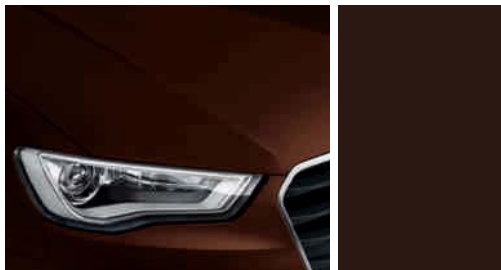

Beluga brown, metallic



Scuba blue, metallic

Pearl effect paint finishes



Misano red, pearl effect

Crystal effect paint finishes



Estoril blue, crystal effect

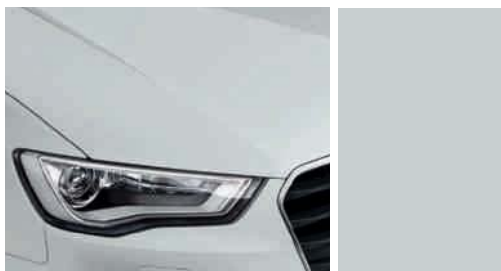

Glacier white, metallic



Phantom black, pearl effect



Panther black, crystal effect

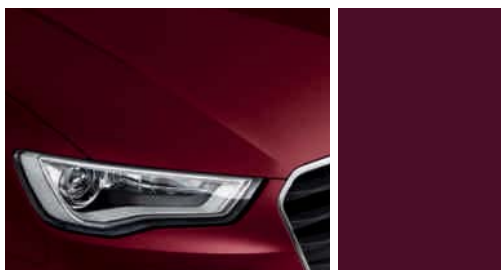

Shiraz red, metallic

Audi exclusive customised paint finishes



Audi exclusive customised paint finishes*
From quattro GmbH

*For information on when this feature will be available, please contact your Audi partner.

Wheels/tyres



Steel wheels, including full wheel covers
size 6.5 J x 16 with 205/55 R 16 tyres



Cast aluminium wheels in 5-arm design
size 7.5 J x 17 with 225/45 R 17 tyres
(optionally available with run-flat tyres)



Audi exclusive cast aluminium wheels in 5-twin-spoke design
size 7.5 J x 17 with 225/45 R 17 tyres.
From quattro GmbH



Cast aluminium wheels in 5-twin-spoke star design (S design)
anthracite, partly polished,
size 7.5 J x 18 with 225/40 R 18 tyres



Cast aluminium wheels in 10-spoke design
size 6.5 J x 16 with 205/55 R 16 tyres



Cast aluminium wheels in 5-arm kinetic design
size 7.5 J x 17 with 225/45 R 17 tyres
(optionally available with run-flat tyres)



Cast aluminium wheels in 5-arm dynamic design
anthracite, partly polished,
size 7.5 J x 18 with 225/40 R 18 tyres



Audi exclusive cast aluminium wheels in 5-arm rotor design in black, high-gloss turned finish
size 7.5 J x 18 with 225/40 R 18 tyres.
From quattro GmbH



Cast aluminium wheels in 15-spoke Y design
size 7 J x 16 with 205/55 R 16 tyres



Cast aluminium wheels in 15-spoke design
size 7.5 J x 17 with 225/45 R 17 tyres
(optionally available with run-flat tyres)



Cast aluminium wheels in 5-parallel-spoke design (S design)
partly polished,
size 7.5 J x 18 with 225/40 R 18 tyres



Audi exclusive cast aluminium wheels in 10-spoke design*
size 7.5 J x 18 with 225/40 R 18 tyres.
From quattro GmbH

Wheels/tyres



Steel winter wheels including full wheel covers
size 6 J x 16 with 205/55 R 16 tyres, permissible top speed 210 km/h, can be fitted with snow chains



Cast aluminium winter wheels in 5-arm dynamic design
size 7.5 J x 18 with 225/40 R 18 tyres, permissible top speed 240 km/h, cannot be fitted with snow chains



Cast aluminium winter wheels in 10-spoke design
size 6.5 J x 16 with 205/55 R 16 tyres, permissible top speed 210 km/h, cannot be fitted with snow chains



Cast aluminium winter wheels in 5-parallel-spoke design (S design)
size 7.5 J x 18 with 225/40 R 18 tyres, permissible top speed 240 km/h, cannot be fitted with snow chains



Cast aluminium winter wheels in 5-arm design
size 6 J x 17 with 205/50 R 17 tyres, permissible top speed 210 km/h, can be fitted with snow chains

Anti-theft wheel bolts

can only be loosened using adapter provided

Tyre repair kit

with 12V compressor and tyre sealant, top speed 80 km/h

Tyre pressure loss indicator

visual and acoustic warning if the pressure drops in one or more tyres

Vehicle tool kit

in the luggage compartment

Vehicle jack

in the luggage compartment

Spare wheel, space-saving

Run-flat tyres

Journey can be continued on a flat tyre at a speed of up to 80 km/h and for a maximum distance of 30 km, without having to change the wheel.

*For information on when this feature will be available, please contact your Audi partner.



Standard seats, front

with manual fore/aft and backrest angle adjustment; manual adjustment of the seat height (on the driver and front-seat passenger side) as well as head restraint and belt height. (The image shows standard seat, front, in Milano leather, pashmina beige.)

Cloth upholstery and trim



Marathon cloth, black



Regatta cloth/mono.pur, black

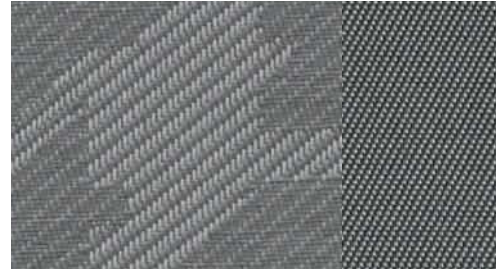

Marathon cloth, titanium grey

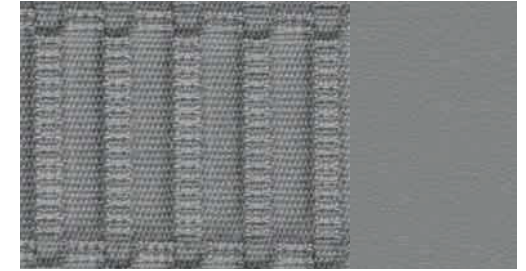

Regatta cloth/mono.pur, titanium grey

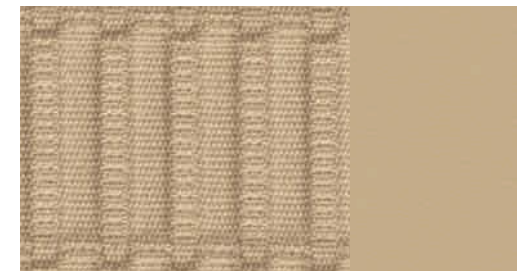

Regatta cloth/mono.pur, pashmina beige

Cloth upholstery and trim



Regatta cloth/mono.pur, chestnut brown

Leather upholstery and trim



Milano leather, black



Audi exclusive leather upholstery and trim*
From quattro GmbH



Milano leather, pashmina beige

*For information on when this feature will be available, please contact your Audi partner.



Sport seats, front

with shaped side bolsters for better lateral support when cornering, manual fore/aft and backrest angle adjustment, manual adjustment of the seat height (on the driver and front-passenger side), the head restraint and belt height as well as the seat cushion angle adjustment; with extendable thigh support; in S3 include S embossing on the front-seat backrests.

(The image shows sport seats, front, in rallye cloth, black/silver.)

Cloth upholstery and trim

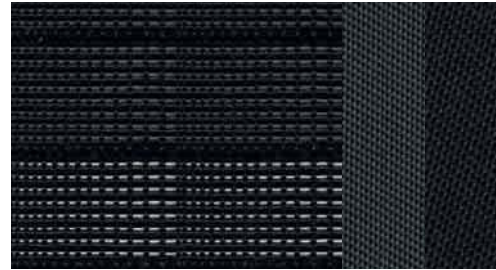

Rallye cloth, black/black

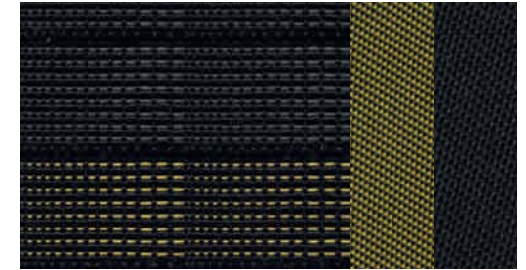

Rallye cloth, black/yellow

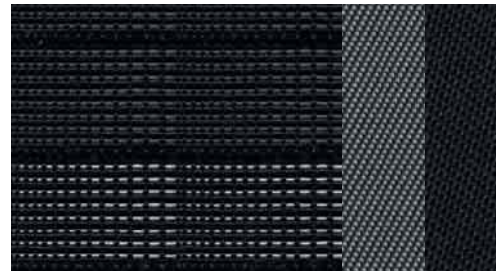

Rallye cloth, black/silver



Rallye cloth, black/blue

Cloth/leather upholstery and trim

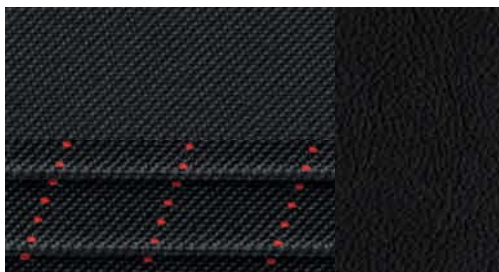

Trophy cloth/leather

Leather upholstery and trim



Milano leather, black

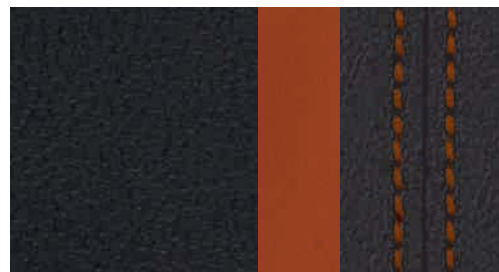

Audi design selection Capri orange

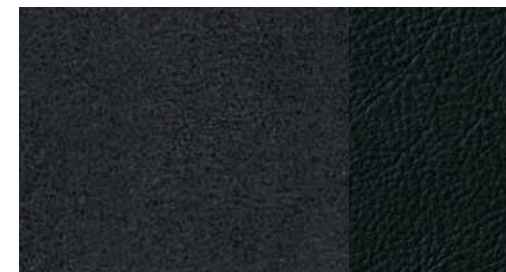

Alcantara/leather, black



Milano leather, titanium grey

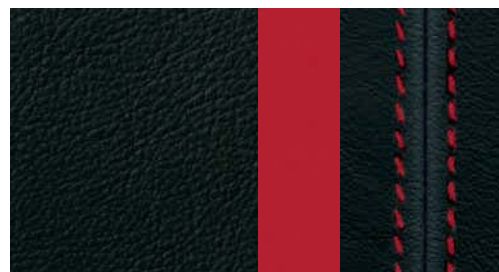

Audi design selection parade red



Alcantara/leather, titanium grey



Milano leather, chestnut brown



Alcantara/leather, black/lunar silver

Leather upholstery and trim



Fine Nappa leather, black



Audi exclusive leather upholstery and trim*
From quattro GmbH



Fine Nappa leather, lunar silver



S sport seats, front

with integrated head restraints, shaped side bolsters for better lateral support when cornering, manual seat adjustment including adjustment of the seat cushion angle and with extendable thigh support; in S3 include S embossing on the front-seat backrests.
(The image shows S sport seat, front, in fine Nappa leather, black.)

Leather upholstery and trim

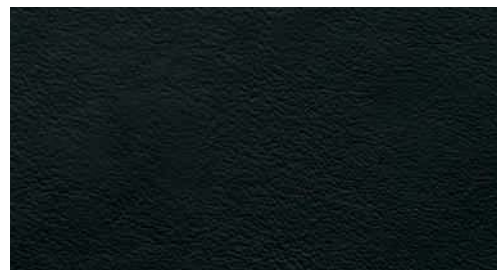

Fine Nappa leather, black

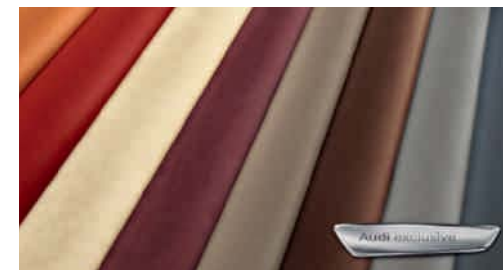

Audi exclusive leather upholstery and trim*
From quattro GmbH

*For information on when this feature will be available, please contact your Audi partner.

Cloth/leather upholstery and trim**Marathon cloth**

for standard seats, front, seat centre panels in marathon cloth, seat side bolsters, head restraints as well as door and rear side panel inserts in single-colour cloth

Regatta cloth/mono.pur

for standard seats, front, seat centre panels in regatta cloth, seat side bolsters, head restraints, front centre armrest (if ordered) as well as door and side trim inserts at the front and rear in matching colours in mono.pur

Rallye cloth

for sport seats, front, seat centre panels in rallye cloth, seat side bolsters, head restraints as well as door and rear side panel inserts in single-colour cloth

Trophy cloth/leather

for sport seats, front, seat side bolsters, head restraints, upper backrest area, gear lever knob or selector lever knob and gear lever or selector lever gaiter in black leather, front centre armrest (if ordered) in synthetic leather; seat centre panel in trophy cloth, black, shoulder area in trophy cloth, black/parade red, contrasting stitching on the seat side bolsters; with S embossing in the front-seat backrests

Alcantara/leather combination

for sport seats, front, head restraint centre panels, seat side bolsters, gear or selector lever knob, gear or selector lever gaiter in leather, front centre armrest (if ordered) in synthetic leather, seat centre panel and door trims in Alcantara; in S3 with S embossing on the front-seat backrests

Milano leather upholstery and trim

seat centre panel, seat side bolsters and head restraint centre panel in Milano leather, with sport seats shoulder area and door trim in matching colour in velvet leather, front centre armrest (if ordered) in synthetic leather

Fine Nappa leather

for sport seats, front, and S sport seats, front, seat upholstery, head restraints, door trim inserts and front centre armrest (if ordered) in fine Nappa leather, with front sport seats shoulder area in matching colour in velvet leather with contrasting stitching, with front S sport seats shoulder area in fine Nappa leather embroidered with contrasting stitching; in S3 each with S embossing on the front-seat backrests

Audi design selection Capri orange

for sport seats, front, seat centre panel, seat side bolsters and head restraint centre panel in Milano leather, black, with contrasting stitching in Capri orange; front centre armrest (if ordered), knee pad and armrest in the doors in fine Nappa leather, black with contrasting stitching in Capri orange; shoulder area and door mirrors in velvet leather, Capri orange; including leather-covered sport steering wheel in 3-spoke design in black with contrasting stitching in Capri orange, gear or selector lever knob and gear or selector lever gaiter in black leather with contrasting stitching in Capri orange; floor mats with piping in Capri orange

Audi design selection parade red

for sport seats, front, seat centre panel, seat side bolsters and head restraint centre panel, front centre armrest, knee pad and armrest in the doors in fine Nappa leather, black with contrasting stitching in parade red, shoulder area and door mirrors in velvet leather, parade red; with S embossing in the front-seat backrests and leather-covered sport steering wheel in 3-spoke design in black with contrasting stitching in parade red, gear or selector lever knob and gear or selector lever gaiter in black leather with contrasting stitching in parade red; floor mats with piping in parade red

Audi exclusive leather upholstery and trim in Alcantara/fine Nappa leather*

for sport seats, front, and S sport seats, front, seat side bolsters, head restraints and front centre armrest (if ordered) in fine Nappa leather, seat centre panel, door trim inserts and front shoulder area in Alcantara; optionally with coloured stitching; in S3 with S embossing in the front-seat backrests; package includes floor mats with leather piping. From quattro GmbH

Audi exclusive leather upholstery and trim in fine Nappa leather*

seat centre panel, seat side bolsters, head restraints and front centre armrest (if ordered) in fine Nappa leather for standard seats, front, and S sport seats, front. Door trim inserts in fine Nappa leather. Shoulder area of sport seats, front, in velvet leather or, for S sport seats, front, in fine Nappa leather; optionally with coloured stitching; in S3 with S embossing on the front-seat backrests; package includes floor mats with leather piping. From quattro GmbH

Audi exclusive extended leather upholstery and trim*

leather-covered armrests in the doors and knee pads in the centre console. From quattro GmbH

Extended interior elements mono.pur

visual accentuation of the knee pads and armrests in the doors, including stitching in the colour of the seat upholstery; the material of the interior elements underlines the high-grade character of the vehicle interior

Headlinings**Headlining in lunar silver cloth**
Attachments in lunar silver**Headlining in black cloth**
Attachments in black



Inlays
in door trims and instrument panel.
(The image shows the inlay in aluminium mistral.)

Inlays



Micrometallic, silver



Matt brushed aluminium

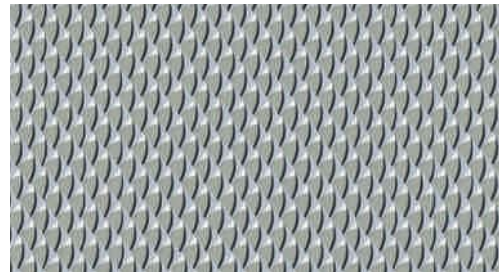

3D-design "Optic"



3D-design "Black"



Aluminium mistral

Lights



LED headlights*

with the following elements in LED technology: dipped beam, high beam, combined daytime running light, position light and indicator function in single light guide, static turning light as well as all-weather light and motorway light function; all-weather light function to reduce the risk of the driver being dazzled when visibility is poor (in fog, rain or snow), the turning light supplements illumination alongside the vehicle in tight bends and when turning corners, additional motorway light which automatically doubles headlight range from a speed of approximately 110 km/h; LED technology allows near daylight illumination of the road for increased safety and comfort; minimum energy requirements, long service life and excellent recognition by other road users thanks to the striking Audi lighting pattern with daytime and night-time design. The headlights also have 3 different light distribution patterns which are activated depending on the vehicle speed: town light, motorway light and country light. In addition, Audi connect enables these 3 light distribution patterns to be controlled by the vehicle support system based on navigation data, and with the aid of stored route data from the optional MMI navigation plus with MMI touch; in this configuration the convenient functions of the lighting assistant are supplemented by the junction light, which provides a broad spread of light from the front lighting system, and by the travel mode with GPS-assisted switching between right- and left-hand drive modes; including LED rear lights.



xenon plus including headlight cleaning system

The headlights with durable gas discharge technology for dipped and high beam enable an intensive illumination of the road with evenness and range, in a colour resembling daylight both close-up and in the distance. The automatic dynamic headlight range control prevents oncoming traffic from being dazzled; including LED daytime running light strip with low energy consumption and LED rear lights. The headlight cleaning system uses water and high pressure, for improved illumination and good visibility through reduced scatter.

Headlights

Halogen headlights using free-form technology with clear glass cover, electric headlight range control and parking light function, daytime running lights

Headlight cleaning system

uses water and high pressure, for excellent illumination and improved visibility

Front fog lights

halogen, new design, integrated harmoniously into the front apron



LED rear lights

Brake, indicator and rear lights in LED technology, new design language with three-dimensional floating effect for the light guide, with reversing lights and rear fog lights

Rear lights

with reversing lights in white and rear fog lights, including high-mounted third brake light and LED number plate light

adaptive light

consisting of dynamic cornering light and static turning light; the dynamic cornering light identifies the course of the road from the movement of the steering wheel and variably illuminates bends by pivoting the xenon headlights; operational between speeds of approx. 10 km/h and 110 km/h. The static turning light automatically switches on if the indicators have been engaged for a while at a low vehicle speed and illuminates the new direction in which the vehicle is travelling. The headlights also have 3 different light distribution patterns which are activated depending on the vehicle speed: town light, motorway light and country light. In addition, Audi connect enables these 3 light distribution patterns to be controlled by the vehicle support system based on navigation data, and with the aid of stored route data from the optional MMI navigation plus with MMI touch; in this configuration the convenient functions of the lighting assistant are supplemented by the junction light, which provides a broad spread of light from the front lighting system, and by the travel mode with GPS-assisted switching between right- and left-hand drive modes.

Variable headlight range control

The variable headlight range control system features a camera on the interior mirror which registers sources of light from other road users within system limits. The range and width of the headlight beam are continuously varied between dipped and high beam to suit ambient conditions, ensuring that the headlights provide good visibility without dazzling other road users.

Lights

High-beam assist

working within system limits, automatically detects the headlights of oncoming traffic, the rear lights of other road users and built-up areas. Depending on the traffic situation, the high beam is automatically switched on or off.

Adaptive brake light

Brake light flashes during an emergency stop to warn following traffic, and automatically activates the hazard warning light if the vehicle comes to a standstill

Interior lighting

front and rear, with delayed switch-off and contact switches on all doors; glove compartment and luggage compartment lighting

Lighting package

Anti-glare lighting for the passenger compartment comprising door sill and footwell lighting at the front (in A3 Sportback also at the rear) as well as illuminated door openers, vanity mirrors and illuminated cup holders, 2 reading lights each at the front and rear, reflected lighting for the centre console and inside of the door to help occupants better orient themselves, using energy-saving and long-life LED technology; active door reflectors

Light/rain sensor

includes windscreen with grey strip along the top; for controlling the automatic headlights, the windscreen wipers and the coming home/leaving home function: delayed off/automatic on for main headlights and – if ordered – front fog lights, rear and number plate lights and, in conjunction with xenon plus, the LED daytime running light when parking/opening the vehicle

Mirrors



Exterior mirrors with integrated LED indicator

electrically adjustable, aspherical mirror glass on the left, convex on the right. Housing painted in body colour in A3/A3 Sportback, in aluminium look in S3

also optionally:

heated

including heated windscreen washer jets

heated and electrically folding

including heated windscreen washer jets and automatic kerb-side function for the exterior mirror on the passenger side

heated, electrically folding and automatically dimming on the driver side

including heated windscreen washer jets and automatic kerb-side function for the exterior mirror on the passenger side

The automatic kerb-side function tilts the exterior mirror on the passenger side downwards when reverse gear is engaged, giving the driver a better view of the kerb.

Interior mirror, dimming

Interior mirror, automatically dimming with light/rain sensor and grey strip

Illuminated vanity mirror

in driver and passenger sun visor

Roof systems



Panoramic glass sunroof

electric activation to tilt and fully open the glass section, opens and closes automatically, tinted glass insert with manual, infinitely adjustable sun shield, convenience closing from outside via the remote control key; the extra-large glass area floods the interior with light to create a pleasant ambience, good acoustics whether the roof is tilted or fully open, integrated wind deflector reduces wind noise when the roof is open.

Roof rails, anodised

for transportation of items, strong and aerodynamically shaped, in aluminium

Roof rails, black

for transportation of items, strong and aerodynamically shaped, in aluminium

Closing systems

Remote control key

unlocks and locks doors, luggage compartment lid and tank flap; includes convenient closing/opening of the windows; in S3 with S3 emblem

Convenience key

with access and drive authorisation system; the key only needs to be carried with you; the engine is started and switched off via the engine start-stop button on the centre console, the vehicle is locked from outside via buttons on the driver and front-seat passenger door handles. The vehicle can also be opened from the tailgate.

Electronic immobiliser

integrated in the engine control unit, automatically activated by the car key

Anti-theft alarm

with tow-away protection via angle of inclination sensors (can be switched off), including interior monitoring system (can be switched off); signal horn (back-up horn) for monitoring doors, bonnet and luggage compartment lid independent of vehicle electrical system

Preparation for tracking system

Preparation for connecting a tracking system that enables a stolen vehicle to be located; available from Audi Genuine Accessories

Glazing

Acoustic windscreen

for improved windscreen insulation and a reduction of outside noise

Rear window

heated, with timer switch; additional heating of the rear window wiper in the lower end position

Dark-tinted windows (privacy glazing)

Dark-tinted rear window and rear side windows

Windscreen cleaning system

2 speeds, 4-speed adjustable intermittent wipe, flick-wipe function, automatic wash-wipe, with reversing wiper system and park setting to increase the service life of the wiper blades; when reverse gear is selected the rear window wiper is activated for the duration of the reversing manoeuvre (if front wipers are switched on)

Sun visors

can be folded and swivelled, on the driver and front passenger sides with covered vanity mirror

Further exterior equipment



S line roof edge spoiler

painted in body colour, with aerodynamic inserts at the side in high-gloss black, in a sporty, striking design

Roof edge spoiler

painted in body colour, with aerodynamic inserts at the side in high-gloss black

S3 roof edge spoiler

painted in body colour, with aerodynamic inserts at the side in high-gloss black, in a sporty, striking design

Model/technology name

in A3/A3 Sportback on the luggage compartment lid, quattro logo (on quattro models*) in the Singleframe and on the luggage compartment lid as well as on the passenger side of the dashboard; in S3 with S3 logo in the Singleframe and on the luggage compartment lid as well as on the leather-covered sport steering wheel and on the rev counter; quattro logo on the passenger side of the dashboard; on request all vehicles can be supplied without model name on the rear

Audi Singleframe

on A3/A3 Sportback chrome-plated trim frame around the radiator grille in stone grey with chrome-plated Audi rings in the centre; on S3 radiator grille in platinum grey with horizontal chrome struts, with chrome-plated Audi rings in the centre

Further exterior equipment

Exhaust tailpipes

single for the 1.6 TDI (77 kW), 2 tailpipes on the left for other petrol and diesel engines; chrome-plated with the equipment lines Ambition and Ambiente as well as in conjunction with the S line exterior package; for S3 dual-branch design, 2 oval chrome-plated tailpipes each on the left and right

Bumpers

plastic-coated, painted in body colour; on S3 with accentuated side air inlets, side sill trims and S rear diffuser in a sporty, striking design

High-gloss package

Decorative roof strips, side window surrounds and window slot trim in anodised aluminium

Provision for trailer towing hitch

includes the wiring to the spare wheel well, enhanced engine cooling. The trailer towing hitch for retrofitting is available from Audi Genuine Accessories.

Trailer towing hitch

removable and lockable; sphere bar and ball head made of forged steel, the 13-pin socket can be swivelled out of sight behind the bumper skirt. When removed, the trailer towing hitch can be stored in the spare wheel well.

Seats/seating comfort

Convenience entry

Enhanced front-seat folding function for easy access to the rear compartment

4-way lumbar support for the front seats

electric, for driver and front-passenger seats, with horizontal and vertical adjustment

Front-passenger seat with height adjustment

Driver seat, electrically adjustable

Electrical adjustment of seat height, fore/aft position, seat angle and backrest angle for the driver side, front-passenger seat manually adjustable

Front seats, electrically adjustable

Electrical adjustment of seat height, fore/aft position, seat angle and backrest angle

Rear seat backrest, folding

can be split and folded 40:60 or fully

Seat heating, front

heats the seat and backrest centre panel; in case of leather upholstery and trim and sport seats also heats the seat side bolsters; individually adjustable in several stages for driver and front-passenger side



Centre armrest, front

adjustable angle, can be adjusted lengthways

ISOFIX child seat mounting for the front-passenger seat

with deactivation switch for front-passenger airbag, on A3 Sportback including additional child-proof lock on the rear doors

ISOFIX child seat mounting and Top Tether for the outer rear seats

standard mounting for practical attachment of ISOFIX child seats. Including additional attachment point (Top Tether). Recommended child seats can be obtained from your Audi partner.

Steering wheels/gear levers/controls



Leather-covered steering wheel in 4-spoke design
with full-size airbag, adjustable for height and reach, includes gear or selector lever knob in leather

Steering wheel in 4-spoke design
with full-size airbag, adjustable for height and reach



Leather-covered sport steering wheel in 3-spoke design
with full-size airbag, adjustable for height and reach, including gear or selector lever knob in leather; for S3 with S3 emblem and decorative stitching in contrasting colour

Steering wheels/gear levers/controls

**Leather-covered multifunction steering wheel in 4-spoke design**

equipment as leather-covered steering wheel in 4-spoke design; with multifunction buttons for operating the radio and – if available – the driver information system, phone, audio sources and navigation, optionally available with shift paddles behind the steering wheel for changing gear with S tronic

**Leather-covered multifunction sport steering wheel in 3-spoke design, flattened at the bottom**

equipment as leather-covered sport steering wheel in 3-spoke design; with multifunction buttons for operating the radio and the driver information system, phone, audio sources and navigation, optionally available with shift paddles behind the steering wheel for changing gear with S tronic; in S3 with S3 emblem and decorative stitching in contrasting colour

**Leather-covered multifunction sport steering wheel in 3-spoke design**

equipment as leather-covered sport steering wheel in 3-spoke design; with multifunction buttons for operating the radio and the driver information system, phone, audio sources and navigation, optionally available with shift paddles behind the steering wheel for changing gear with S tronic

Audi exclusive leather steering wheel rim¹

available in all Audi exclusive colours. Individual choice of colour for stitching in various Audi exclusive colours with specific Audi exclusive seam detail. From quattro GmbH

Audi exclusive leather controls¹

leather-covered steering wheel rim, gear or selector lever and gear or selector lever gaiter available in all Audi exclusive colours. Individual choice of stitching in various Audi exclusive colours. Stitching on the steering wheel rim with specific Audi exclusive seam detail. From quattro GmbH

**Audi exclusive aluminium gear lever knob¹**

in S3 without S3 logo on the gear lever knob.

From quattro GmbH

Climate control

**Manual air conditioning**

cools and heats up the vehicle passenger compartment, includes 4 air vents in the dashboard, footwell vents front and rear and defroster vents for the windscreen and side windows; features manual recirculation mode, particulate filter, continuously variable blower and manual air distribution

**Auxiliary heating/ventilation¹**

The auxiliary heating warms up the interior and removes ice from the windows; the auxiliary ventilation system supplies fresh air and lowers the temperature on the interior; with timer and departure time programming (an intelligent control function for time and energy-efficient calculation of heating duration); separate radio-operated remote control with illuminated display

Climate control



Deluxe automatic air conditioning

with sunlight-dependent control, separate pre-selectable control for driver and front passenger, electronically regulates the air temperature, air flow rate and air distribution; automatic recirculation mode by means of air quality sensor, combined filter, rear vents, humidity regulation for more efficient climate control, indirect ventilation through defroster nozzle, key-coded settings



Ventilation system and heating

4 round vents in the dashboard that can be individually adjusted to provide directed or diffuse air flow, defroster nozzles for the windscreen and side windows, footwell vents at the front and rear

Luggage securing and storage systems



Storage and luggage compartment package

includes storage nets on the backs of the front-seat backrests, storage net in the front-passenger footwell, 12V socket in the rear centre console, storage compartment under the rear seat (including two high-visibility vests); additional multi-fastening point in the luggage compartment, net in the side trim, combined net, 12V socket

Storage compartments

Storage compartment in the door/side trims, in the centre console and under the front-passenger seat

Clothes hooks

on the B-pillar, on the left and right-hand sides, single



Luggage compartment cover removable

Reversible mat

for the luggage compartment, velour on one side and rubberised on the other, to cover the entire luggage compartment, even with folded rear seat backrest

Lashing points

4 in the luggage compartment, for attaching luggage and other objects, attachment points for the optional combined net

Loading floor

adjustable on 2 levels, practical for the transportation of large items. (Not with quattro² or trailer towing hitch in conjunction with Bang & Olufsen Sound System or Audi sound system)

¹For information on when this feature will be available, please contact your Audi partner.

²For information on when this feature will be available for the A3 Sportback, please contact your Audi partner.

Luggage securing and storage systems



Through-loading facility

enables extended loading possibility for the safe transportation of long objects, includes rear centre armrest with cup holders and storage compartment

Ski/snowboard bag

for the practical and safe transportation of long objects, e.g. up to 4 pairs of skis or 2 snowboards

Further interior equipment



Door sill trims

on the door sills; in S3 with aluminium insert and S3 logo

Floor mats, front

in velour, coordinated with the carpet colour

Floor mats, rear

in velour, coordinated with the carpet colour

Window controls

electric, with safety system to limit maximum closing force, convenience opening/closing via remote control key, one-touch opening/closing function



Aluminium look in the interior

on vents, glove compartment, mirror adjustment switches, window control switches, frame around the inside door handle, coin box, control buttons for the parking brake and – if ordered – the hold assist

Centre console

with storage compartment

Cigarette lighter and ashtrays

removable, chrome-plated cover with Audi rings, cigarette lighter replaces the standard 12V socket in the centre console

12V socket

in the front centre console

Mobile phone/key holder*

cup with chrome ring installed in the centre console, with a separate snug storage compartment each for mobile phone and keys

Grab handles

damped action, 4 hinged handles recessed into the roof

MMI® and navigation systems



MMI® navigation plus with MMI touch

with navigation data (flash memory), electrically extending, high-resolution 7-inch colour display, high-quality representation of the navigation map as 3D ground model with topographical map colouring, display of many sights and city models in 3D, choice of 3 alternative routes provided, split-screen mode for route information (manoeuvring points, points of interest on motorways, TMCpro on route), detailed junction map and lane recommendations, dynamic route guidance (where available), navigation-based speed limit display, voice control system (whole-word entry of address in one sentence), additional arrow display in the driver information system; incl. radio with triple tuner and phase diversity, flash memory for music (10 GB), MP3, WMA, AAC and MPEG4-capable DVD player can also be used for music and video DVDs, 2 SDXC card readers (for up to 2 TB), Audi music interface (connection of 4th generation and higher Apple iPods, music functionality of Apple iPhone as well as USB storage media and MP3 players), Bluetooth interface with Bluetooth audio streaming and 8 passive speakers with a total output of 80 watts. In addition, it is possible to have e-mails displayed by the mobile phone in selected languages and have them read out in high-quality speech output.¹ In combination with Audi connect² it is possible to use various services such as navigation using Google Earth images³ and Google Maps Street View³, weather and news as well as Audi traffic information online.

MMI touch: a touch-sensitive control panel on the rotary/push-button control for intuitive operation of the MMI without drivers taking their eyes off the road; context-related entry of letters and numbers via handwriting recognition with acoustic acknowledgement for navigation destination, selection from address book, entry of telephone numbers or search for media files; simple movement of navigation map and selection of points of interest

Navigation package

includes the connectivity package (Audi music interface, Bluetooth interface with Bluetooth audio streaming, preparation for navigation system, additional SDXC card reader up to 2 TB) and navigation data (SD card), maps shown on electrically extending 5.8-inch colour display, operation via MMI radio, leather-covered multifunction steering wheel or voice control system

Navigation data (SD card)

currently contains navigation data for the following countries (where digitised): Albania, Andorra, Austria, Belarus, Belgium, Bosnia-Herzegovina, Bulgaria, Croatia, Cyprus, Czech Republic, Denmark, Estonia, Finland, France, Germany, Gibraltar, Greece, Hungary, Iceland, Ireland, Italy, Kosovo, Latvia, Liechtenstein, Lithuania, Luxembourg, Macedonia, Malta, Moldova, Monaco, Montenegro, the Netherlands, Norway, Poland, Portugal, Romania, Russia, San Marino, Serbia, Slovakia, Slovenia, Spain (including the Canary Islands), Sweden, Switzerland, Turkey, the UK, Ukraine, Vatican City

Driver information system (monochrome display)

supplies the driver with lots of useful information on a 3.5-inch monochrome display; among other things it shows the current radio station or music title, speed, outdoor temperature, time and – if available – information from navigation and driver assistance systems. The onboard computer with short- and long-term memory provides information about average and current fuel consumption, average speed as well as driving time and distance covered, among other things. The integrated efficiency program assists the driver by providing consumption data summaries, a display of additional consumers, a larger gear display and tips for more fuel-efficient driving. In conjunction with a multifunction steering wheel radio and media lists and the telephone menu are displayed; incl. attention assist.

The integrated attention assist uses various sensors to analyse driving behaviour. If the evaluation indicates that the driver's attention is lapsing, the system recommends a break. Steering movements and pedal actuation, for example, are recorded and compared with the individual driving patterns of the respective driver. Attention assist warns the driver by means of a display in the driver information system and an acoustic signal. The system is active between 65 km/h and 200 km/h and can be deactivated at any time.

¹ Provided the mobile telephone has the Bluetooth profile MAP (Message Access Profile). Please contact your Audi partner or visit www.audi.com/bluetooth for information on compatible mobile phones. Available in German, English, French, Italian and Spanish. ² Further information about Audi connect can be found on pages 44 and 45 and on page 109. The availability of the services supported by Audi connect varies from country to country. For more information, please contact your Audi partner. ³ Google and the Google logo are registered trademarks of Google Inc.

MMI® and navigation systems

**Driver information system (colour display)**

Equipment as driver information system (monochrome display) but with high-resolution colour display for an even better overview and legibility; information related to adaptive cruise control and speed limit display – if available – can be displayed.

Radio systems

**Audi radio**

- Pop-up control panel with 2.5-inch display
- CD player (MP3- and WMA-capable) and AUX-IN connection
- 6 preset buttons for an overall 24-station memory, FM (VHF) and AM (MW) reception incl. phase diversity and speed-dependent volume control
- 4 speakers at the front, total output 40 watts

Digital radio reception

In addition to the range of analogue stations, programmes from digitally broadcast radio transmitters with better sound quality can be received according to DAB standard, including DAB+ and DMB audio. Display of additional information accompanying the programme (e.g. artist, title, cover) in the form of a slide show and other programme-independent data services (e.g. weather, traffic, news). In conjunction with MMI navigation plus with MMI touch, a 2nd DAB tuner permanently searches for alternative reception frequencies of the set radio station; at the same time the station list is updated. Please note: Reception depends on local digital network availability; contents and scope of the additional information depend on provision by the respective radio station.

**MMI® radio**

- Integrated MMI control concept, comprising an electrically extending 5.8-inch colour display, separate MMI control panel and car menu
- CD player and SDHC memory card reader (up to 32 GB), both MP3- and WMA-capable and AUX-IN connection
- 50-station memory with dynamic station list, FM (VHF) and AM (MW) reception incl. display of information about the current radio station (e.g. title and artist, if available); phase diversity and speed-dependent volume control
- 8 speakers at the front and rear, total output 80 watts

Audi sound system

10 speakers including centre speaker in the dashboard and subwoofer in the spare wheel well, 6-channel amplifier with a total output of 180 watts

**Bang & Olufsen Sound System**

Surround sound reproduction via 14 high-performance speakers including centre speaker in the dashboard and subwoofer in the spare wheel well; 15-channel amplifier with a total output of 705 watts; the exclusive speaker covers with aluminium applications and the LED lighting accentuating the front woofers are a perfect design experience. The sound is permanently adapted according to the driving and background noises determined by microphone. 5.1 surround sound reproduction is possible in conjunction with MMI navigation plus with MMI touch and the integrated DVD drive.

Radio systems



Audi music interface

for the connection of portable media players such as Apple iPod generation 4 and higher, Apple iPhone (music functionality) as well as USB storage media and MP3 players. The Audi music interface is housed in the centre console; it is operated via the MMI, a leather-covered multifunction steering wheel or voice command. Note: can only be used with a special adapter cable (available from Audi Genuine Accessories). Please contact your Audi partner or visit www.audi.com/mp3 for information on compatible media players. (Part of connectivity package and MMI navigation plus with MMI touch)

Adapter cable set for Audi music interface

consisting of 2 connecting cables to connect Apple iPod/iPhone or data storage devices/media players with USB port (type A). Other adapter cables are available from Audi Genuine Accessories. Please contact your Audi partner or visit www.audi.com/mp3 for information on compatibility.

Adapter cable set plus for Audi music interface consisting of 2 connecting cables to connect Apple iPod/iPhone or data storage devices/media players with USB port (type A); in conjunction with iPhone and more recent iPod generations the display of cover art and video functions is possible; depends on the device used. Other adapter cables are available from Audi Genuine Accessories. Please contact your Audi partner or visit www.audi.com/mp3 for information on compatibility.

Telephone and communication



Audi phone box

enables drivers to use their mobile phone in the car by placing it in the compartment provided in the centre console; comprises a hands-free facility and voice control for the telephone functions; including connection to the vehicle aerial via the integrated coupling aerial in the storage compartment, reducing SAR radiation inside the vehicle; can be charged via USB port; it is operated via the MMI control panel, the multifunction buttons on the steering wheel or voice command. Please contact your Audi partner or visit www.audi.com/bluetooth for information on compatible mobile phones.

Bluetooth interface

Bluetooth-capable mobile phones can be connected to the vehicle via the interface; hands-free calls are possible in the vehicle via the microphone. Including Bluetooth audio streaming (depending on mobile phone compatibility). Please contact your Audi partner or visit www.audi.com/bluetooth for information on compatibility.

Audi connect

convenient connection of your vehicle to the internet for the use of Audi connect via an integrated UMTS module. SIM card reader in the trim of the MMI navigation plus with MMI touch. Audi connect supports the following services:

- Navigation with the aid of Google Earth images¹ and Google Maps Street View¹
- Point-of-interest (POI) search including voice control
- Destination entry via myAudi or Google Maps¹
- Travel information and weather
- Wi-Fi hotspot for access to the internet from the rear using a mobile device (e.g. laptop)
- Audi music stream
- Traffic information online²
- City events²
- Fuel stop²
- Flight and train information²
- News online (customised)²
- Picture book navigation²
- Access to Facebook and Twitter²

The services supported by Audi connect are only available with mobile phone contracts with data option and only within the range of the respective mobile phone networks, and can be subject to a 36-month usage limit. Activation in the vehicle and clearance on the www.audi.com/myAudi is necessary for some services, and in the last case mentioned an additional registration is necessary. Additional costs can be incurred for the reception of data packets from the internet, depending on the terms of your mobile phone contract, particularly when used abroad: because of the high data volumes involved, the use of a data flat rate is strongly recommended. Please contact your mobile service provider for more detailed information. The availability of the services supported by Audi connect varies from country to country. For more information, please contact your Audi partner. Visit www.audi.com/myAudi for more detailed information about Audi connect and the respective conditions of use.

¹ Google and the Google logo are registered trademarks of Google Inc. ² The fuel stop, flight and train information and city events services supported by Audi connect require clearance. The picture book navigation and news online (customised) services as well as access to Facebook and Twitter require clearance and individual configuration. Both procedures can be carried out following registration on the myAudi platform under www.audi.com/myAudi. The usage rights of the services mentioned and the traffic information online service are limited to 36 months following initial activation in the vehicle (providing this takes place within 6 months of vehicle registration; otherwise corresponding shortening of the usage rights). Your Audi partner will be happy to inform you about possible extension options and any costs these may incur.

Telephone and communication

Connectivity package

Audi music interface (for connecting generation 4 and higher Apple iPods, music functionality of Apple iPhones as well as USB storage media and MP3 players), Bluetooth interface (for connecting Bluetooth-capable mobile phones) with Bluetooth audio streaming, navigation system preparation (navigation function and map data available as retrofit solution from Audi Genuine Accessories), additional SDXC card reader (up to 2 TB). Note: In conjunction with the Audi music interface, the AUX-IN connection is omitted.

Assistance systems

Audi active lane assist

lane compliance assistant, helps the driver within system limits to keep comfortably in lane (operating range from about 60 to maximum 250 km/h). If the system is activated and ready and the driver has not operated the indicators, the Audi active lane assist will guide the vehicle within recognised lane boundary lines by means of gentle corrective steering intervention; the driver can choose whether to be monitored continuously or just shortly before crossing the traffic lane marker (choice of earlier or later steering time); additional steering vibration can be adjusted if the driver wishes; incl. high-beam assist, working within system limits, it automatically detects the headlights of oncoming traffic, the rear lights of other road users and built-up areas. Depending on the traffic situation, the high beam is automatically switched on or off. Camera-based traffic sign recognition is included in conjunction with MMI navigation with MMI touch.

Camera-based traffic sign recognition

Camera-based recognition and display of overtaking bans and speed limits, including temporary speed limit displays (e.g. above motorways). Additionally, working within system limits, there is an evaluation of the particular situation in wet conditions, of time-dependent speed limits, of road works and when using a trailer. If a sign has not been recognised by the camera, the speed limit displayed can be taken from the navigation data (where available) thanks to Audi connect. (Western Europe only)

Audi side assist

lane change assistant, working within system limits at speeds of 30 km/h and above, the system uses radar technology to monitor the area on the left, right and behind the moving vehicle and informs or warns the driver by means of an LED display in both exterior mirrors if the Audi side assist has detected another vehicle assessed as critical for lane-changing



adaptive cruise control

automatic distance control (control range for manual transmission 30-150 km/h, for S tronic 0-150 km/h; in conjunction with the optional assistance package with extended control range up to 200 km/h) also up to standstill (S tronic only) and automated restart on driver's request; working within system limits it uses a radar sensor to detect vehicles ahead and maintain this distance by automatic braking and accelerating; 4 distance levels and different driving modes can be selected individually; including Audi pre sense front: warns the driver through an enhanced brake assist of any imminent threat of collision with the vehicle in front; in addition, full braking action is initiated at speeds below 30 km/h if there is a danger of collision with a stationary or moving vehicle, in order to avoid this collision if possible.

Assistance package

The assistance package contains the functions of the following assistance systems: parking system plus with selective display, Audi active lane assist and adaptive cruise control with extended control range (for manual transmission 30-200 km/h, for S tronic 0-200 km/h)



Hold assist

holds the vehicle stationary for unlimited periods after stopping and thus prevents the vehicle rolling away on many hills and on gradients. The system is activated by push-button and allows the driver to drive off easily and comfortably without having to operate the electromechanical parking brake.

Cruise control

at speeds of 30 km/h and above, the system keeps the set speed constant, provided that engine power and engine braking effect permit it; operated via separate steering column stalk, set speed displayed in driver information system (if fitted)

Audi pre sense basic

Networking the different vehicle systems enables driving situations to be categorised and, where necessary, actions to be implemented for preventive occupant protection. These include: tensioning of the front seat belts as well as closing of the windows and – if fitted – the panoramic glass sunroof.

Assistance systems

Parking system, rear

makes reverse parking easier within system limits by indicating acoustically how far away the vehicle is from an object detected behind the vehicle; measurement is by ultrasonic sensors integrated discreetly in the bumper

Parking system plus with selective display

acoustic and visual parking aid for front and rear. Working within system limits, a white segment indicates a detected obstacle outside the vehicle. Red segments represent obstacles in the driving path. This provides the driver with a selective optical view in the MMI display of all the objects recognised, depending on the current bend radius and direction of travel. The virtual lane display in conjunction with MMI navigation plus with MMI touch additionally provides guidelines at the sides which are calculated at in advance depending on the current angle of turn, thus supporting safe and scratch-free parking and leaving of parking spaces by specifying the right steering angle; measurement is by ultrasonic sensors integrated discreetly in the bumpers, can optionally be ordered with rearview camera



Park assist with selective display

as parking system plus with selective display; in addition ultrasonic sensors are used to search for parking spaces by the roadside, calculate the ideal parking path for cross parking spaces and the ideal path for parking and leaving kerb-side parking spaces; the steering action is performed entirely by the system. Assisted parking is now even possible in smaller parking spaces and bend areas; parking in several moves is supported. Steering is done by the vehicle, while the driver only needs to accelerate and apply the brakes. The display of surroundings has 4 additional sensors which, depending on the steering angle, indicate obstacles detected all around and at the side of the vehicle and warn the driver, thus supporting safe and scratch-free parking and leaving of parking spaces by showing the lane; can optionally be ordered with rearview camera

Rearview camera

Camera image of area behind the vehicle shown on the MMI display, with dynamic display modes showing the calculated path (steer-angle dependent); includes auxiliary lines and guidelines in the camera image and for identification of the point at which to apply opposite lock when parallel parking; rearview camera integrated discreetly in the handle strip of the luggage compartment lid

Suspensions/brakes

Dynamic suspension

McPherson spring strut type axle at the front with aluminium lower wishbones, aluminium subframe and tubular stabiliser. 4-link rear axle with separate spring/damper arrangement, subframe and tubular stabiliser; the 1.6 TDI (77 kW) entry-level engine has a lightweight compound link rear suspension.

Sport suspension

body lowered by approx. 15 mm, with stiffer set suspension and damping for more direct contact with the road and sporty handling

S sport suspension

more dynamic spring/damper setting and vehicle lowered by 25 mm

S line sport suspension

more dynamic spring/damper setting and vehicle lowered by 10 mm compared with the sport suspension or by 25 mm compared with the dynamic suspension

Suspensions/brakes

Audi magnetic ride

adaptive damper system with individual selection of suspension settings (auto/comfort/sport) operated via button in the front centre console (option for TFSI and TDI engines from 110 kW); improves ride comfort and driving dynamics by regulating the damping forces depending on the driving situation; suspension lowered by 15 mm compared with the dynamic suspension

Audi drive select

changes vehicle characteristics, e.g. by adapting power steering assistance and accelerator and gear change characteristics (for models with S tronic). The system also influences other optional equipment; available modes: comfort, auto, dynamic, efficiency and – in conjunction with MMI radio or MMI navigation plus with MMI touch – individual. The efficiency mode shifts the engine, S tronic, climate control and optional adaptive cruise control or cruise control to a consumption-improved basic setting.



Electromechanical parking brake

includes parking brake function when stationary, drive-off assistance function through automatic release when driving away and full braking action whilst driving acting on all 4 wheels

Brake system

with Antilock Brake System (ABS), Electronic Brake-Force Distribution (EBD); hydraulic brake assist with 2-stage brake booster function (Dual Rate), disc brakes at front and rear, ventilated at front

Secondary collision brake assist

Following an accident, uncontrolled continued vehicle motion is prevented in certain situations. In these cases secondary collisions can be avoided.

Progressive steering¹

enhances driving comfort by reducing steering effort in town traffic and when manoeuvring as well as the driving dynamics through a direct and progressive steering ratio; in addition, the progressive steering also has speed-dependent steering assistance (as with electromechanical power steering), this can be configured via Audi drive select (comfort/auto/dynamic)

Technology/safety

Body

galvanised (fully-galvanised in areas at risk from corrosion), unitary construction, welded to the floor pan, front and rear areas feature defined crumple zones. (12 year guarantee against rust perforation)

Side impact protection

consisting of bending-resistant door impact beams and reinforced body side structure, particularly in the B-pillars and sills

Full-size airbags

for driver and front passenger

Side airbags, front

integrated into the seat backrests

Side airbags, rear

to supplement the side impact protection in the doors

Head airbag system

protects front and outer rear seats in the event of a side impact, unfolds over the entire length of the side windows as a protective cushion; the head airbag system supplements the side impact protection and side airbags.

Knee airbag

on the driver's side

Integrated head restraint system

In the event of a rear-end collision, the design of the seat restrains the upper torso and supports the head, thereby increasing safety and reducing the danger of whiplash.

Safety steering column

increases the safety potential of the seat belt and airbag

Seat belts

3-point inertia reel seat belts for all seats, pyrotechnic seat belt tensioners, belt height adjustment in the front; belt force limiters on all outer seats

Seat belt reminder

for all seats; an acoustic and visual warning signal reminds occupants in the front to fasten their seat belts, a visual warning signal indicates when seat belts have been undone in the rear.

Warning and control lights

for, among others: airbag, ABS, ESC/ASR, parking brake on, EDL electronics, high beam, indicators, brake system, engine oil pressure, luggage compartment lid, engine electrics, preheater system (TDI)

Warning triangle

with bracket on the inside of the luggage compartment lid

First-aid kit

in the storage compartment under the front-passenger seat

Electromechanical power steering

speed-sensitive power steering, with active reset assistance, automatic straight line running correction system, e.g. in side winds or roads with lateral incline; energy saving operating mode, absorbs the effects of disturbances on the road, track stabilising steering scrub radius

Technology/safety

Electronic Differential Lock (EDL)

On surfaces with varying levels of grip, this start-off assistant automatically brakes the drive wheels on any surface that is too slippery, thereby ensuring powerful progress.

Electronic Stabilisation Control (ESC)

can be deactivated, with hydraulic brake assist: The Electronic Stabilisation Control ensures greater stability in hazardous situations through targeted braking of individual wheels and intervention in the engine management system and helps to stabilise the vehicle by changing the steering torque.

Electronic Stabilisation Control (ESC) with electronic axle-differential lock

The electronic cross-axle locking function is integrated in the Electronic Stabilisation Control on front-wheel drive models. It distributes the drive torque by means of targeted braking actions, depending on the driving situation. When cornering, the cross-axle lock actively intervenes before under-steering is even perceptible. This provides improved traction and dynamics when cornering, as well as precise driving. In addition, agility is improved during steering while driving safety is simultaneously increased

Anti-Slip Regulation (ASR)

reduces spinning of the drive wheels by reducing the engine output and delivers more traction and stability on the road surface

Manual transmission

6-speed, all-synchromesh, with hydraulically operated single-disc dry clutch with asbestos-free linings, dual-mass flywheel



S tronic®

The 6- or 7-speed dual-clutch transmission facilitates quick gear changes with no perceptible interruption in power flow; can be operated via the optional shift paddles behind the steering wheel, the selector lever or in automatic mode; includes hill hold assist

Front-wheel drive

Electronic Differential Lock (EDL) through intervention of the braking system on all driven wheels, Anti-Slip Regulation (ASR), Electronic Stabilisation Control (ESC) with brake assist

quattro®²

permanent all-wheel drive for outstanding traction and driving safety

Diesel particulate filter, additive-free

on all diesel models; the automatic filter system reduces soot particle emissions.

Start-stop system

helps to reduce fuel consumption and CO₂ emissions by switching off the engine in stationary phases, e.g. at traffic lights. The start process is initiated as soon as the clutch is pressed (manual transmission) or when the footbrake is released (S tronic). May be deactivated using a switch at any time.

Recuperation

Increasing the generator voltage converts kinetic energy into usable electrical energy when the vehicle is coasting or braking. This recuperated brake energy is used to assist the generator during subsequent acceleration, saving up to 3 % fuel.

Coasting mode

can be activated in efficiency mode in Audi drive select, allows an anticipatory driving style and reduces fuel consumption in "D" mode; automatically disengages when the accelerator is released, automatically re-engages when the brake pedal or accelerator pedal is pressed.

Audi Extended Warranty

Audi Extended Warranty

can only be ordered directly and on purchase of a new car; is a consistent continuation of the manufacturer's guarantee so that you are protected against risk and can control servicing costs even after the first 2 years. 9 combinations of service life and mileage can be selected:

1 additional year under Audi extended warranty, maximum total mileage of 30,000 km

1 additional year under Audi extended warranty, maximum total mileage of 60,000 km

1 additional year under Audi extended warranty, maximum total mileage of 90,000 km

2 additional years under Audi extended warranty, maximum total mileage of 40,000 km

2 additional years under Audi extended warranty, maximum total mileage of 80,000 km

2 additional years under Audi extended warranty, maximum total mileage of 120,000 km

3 additional years under Audi extended warranty, maximum total mileage of 50,000 km

3 additional years under Audi extended warranty, maximum total mileage of 100,000 km

3 additional years under Audi extended warranty, maximum total mileage of 150,000 km

¹For information on when this feature will be available for the A3/A3 Sportback, please contact your Audi partner.

²For information on when this feature will be available for the A3 Sportback, please contact your Audi partner.

More individually ahead: Audi Genuine Accessories.

Give your Audi A3 or A3 Sportback a more personal touch with Audi Genuine Accessories. There are lots of customisation possibilities available for you. What about the sporty style package that will give your vehicle an even more dynamic touch? There are also various high-quality cast aluminium wheels available to add an exclusive highlight.

The equipment for families and leisure ensure enhanced comfort on the road, and the new colour kit film kits allow you to adapt the vehicle colour to your taste. The following pages contain a small selection from the extensive range of Audi Genuine Accessories on offer.

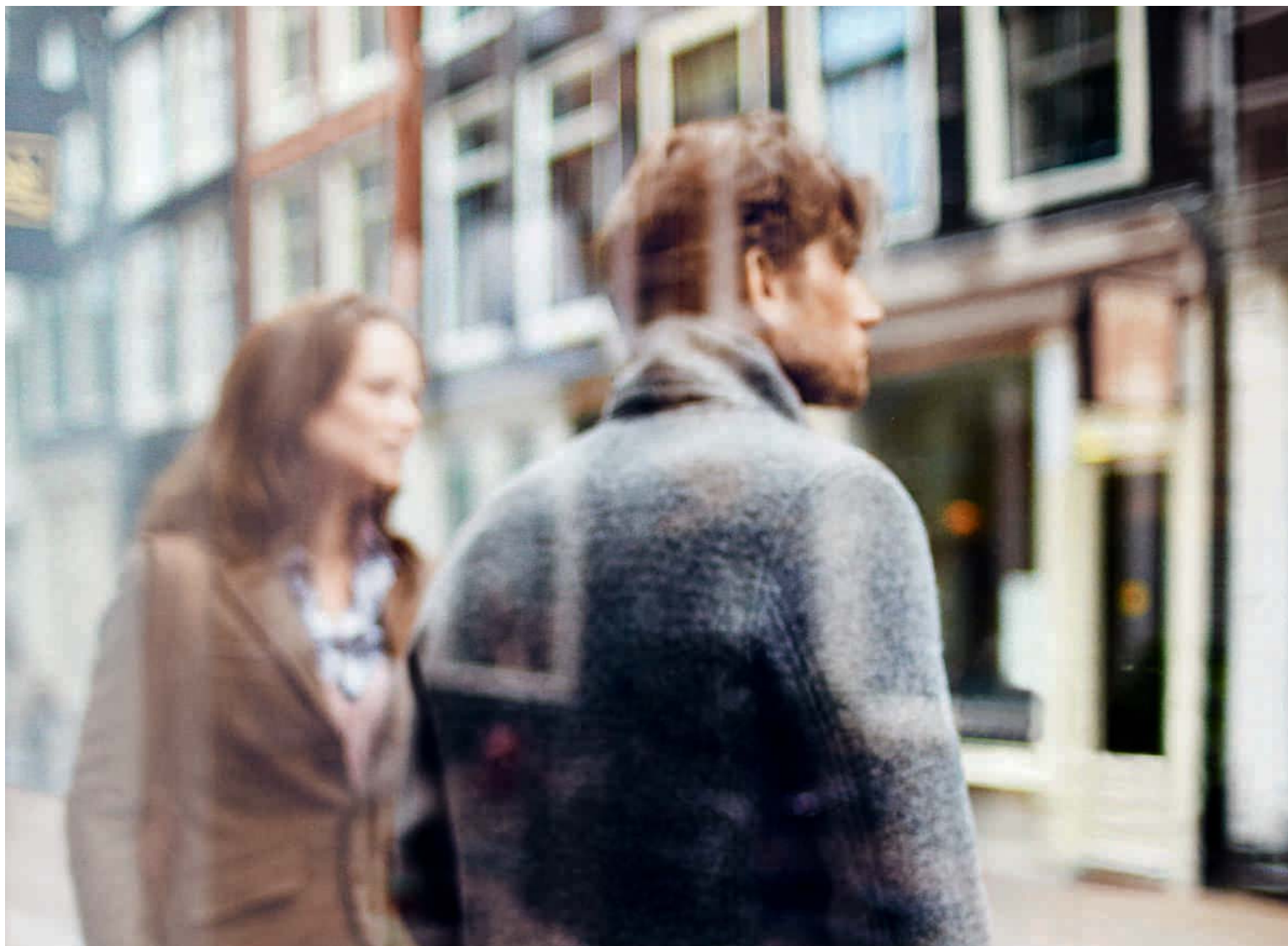

The fuel consumption and CO₂ emission figures can be found from page 118 onwards.



Detailed information can be obtained from the Audi A3 and A3 Sportback accessories catalogue, at www.audi.com and from your Audi partner.





1 Colour kit red interior

Even more individuality on the interior with decorative trims on the interior mirror and centre console, inlays for the instrument panel and door trim as well as attractive textile floor mats. Available in Misano red/ibis white and misty blue/ibis white.

2 Cast aluminium winter wheels in 5-arm rotor design

Complete winter wheel, size 6 J x 16 with 205/55 R 16 tyres, can be fitted with snow chains.

3 Snow chains

For improved grip on snow and ice.

4 Luggage compartment tray

Lip all the way round provides the luggage compartment floor with better protection against soiling. The non-slip pattern reduces any slipping of the load. Simple and compact to stow away. Only for the A3.

5 Audi child seat

Can be used facing forwards or backwards. With adjustable seat, integrated safety harness and adjustable head restraint. Cloth cover can be removed and washed, is breathable and gentle on the skin, certified in accordance with Oeko-Tex® standard 100, in the colours Misano red/black and titanium grey/black. Can only be used in conjunction with ISOFIX-Basis. Suitable for children up to 18 kg (approx. 4 years).

6 Ski and luggage box (480 l)¹

Ski box for winter sports equipment and other luggage. Lockable and can be opened from both sides. Easy to clean thanks to smooth surface. (Can only be used in conjunction with the carrier unit.)

7 Adapter cables for Audi music interface²

Enables the connection of various iPod™ models and other portable media players. Operation via the MMI system, if this function is supported by the media player.

8 Cycle mount

Made of specially moulded aluminium profile and powder-coated steel. Especially easy cycle attachment. Lockable. Maximum load capacity 17 kg. (Can only be used in conjunction with the carrier unit.)



Model	A3/A3 Sportback 1.4 TFSI (90 kW)			A3/A3 Sportback 1.8 TFSI (132 kW)			A3 1.8 TFSI quattro (132 kW)	
Engine type	4-cylinder inline petrol engine with direct fuel injection, turbocharging and indirect intercooling			4-cylinder inline petrol engine with direct fuel injection, turbocharging and intercooling			4-cylinder inline petrol engine with direct fuel injection, turbocharging and intercooling	
Displacement in cc ³ (valves per cylinder)	1395 (4)			1798 (4)			1798 (4)	
Max. output ¹ in kW at rpm	90/5000-6000 [90/5000]			132/5100-6200			132/4500-6200	
Max. torque in Nm at rpm	200/1400-4000			250/1250-5000			280/1350-4500	
Power transmission/wheels								
Drive type	Front-wheel drive			Front-wheel drive			quattro® permanent all-wheel drive	
Transmission type	6-speed manual transmission [7-speed S tronic]			6-speed manual transmission [7-speed S tronic]			[6-speed S tronic]	
Wheels ²	Steel wheels, 6.5 J x 16			Steel wheels, 6.5 J x 16			Steel wheels, 6.5 J x 16	
Tyres ²	205/55 R 16			205/55 R 16			205/55 R 16	
Weights/capacities								
Unladen weight ³ in kg	A3	[1270]	A3 Sportback	A3	[1325]	A3 Sportback	[1425]	
Gross vehicle weight in kg	1250	[1270]	1280	1305	[1325]	[1355]	[1425]	
Permissible roof load limit/nose weight in kg	1735	[1755]	1765	1790	[1810]	[1840]	[1910]	
Trailer load limit ⁴ in kg	75/75	[75/75]	75/75	75/75	[75/75]	[75/75]	[75/75]	
unbraked 12 % gradient 8 % gradient	620	[630]	640	650	[660]	[670]	[710]	
	1400	[1400]	1400	1600	[1600]	[1600]	[1600]	
	1600	[1600]	1600	1800	[1800]	[1800]	[1800]	
Fuel tank capacity, approx. in l	50	[50]	50	50	[50]	[50]	[55]	
Performance/consumption⁵								
Top speed in km/h	203	[203]	203	232	[232]	[232]	[228]	
Acceleration 0-100 km/h in s	9.3	[9.2]	9.5	7.1	[7.2]	[7.3]	[6.7]	
Fuel grade	Sulphur-free super RON 95 ⁷			Sulphur-free super RON 95 ⁷			Sulphur-free super RON 95 ⁷	
Fuel consumption ¹⁰ in l/100 km	urban	6.5	[6.1]	6.6	7.4	[7.0]	[7.0]	[8.2]
	extra-urban	4.4	[4.2]	4.6	4.9	[4.8]	[4.8]	[5.6]
	combined	5.2	[4.9]	5.3	5.8	[5.6]	[5.6]	[6.6]
CO ₂ emissions ¹⁰ in g/km	urban	151	[142]	153	172	[162]	[162]	[189]
	extra-urban	102	[98]	106	113	[112]	[112]	[131]
	combined	120	[114]	123	135	[130]	[130]	[152]
Emission standard	EU5			EU5			EU5	

Model		A3 1.6 TDI (77 kW)	A3/A3 Sportback 2.0 TDI (110 kW)	A3 2.0 TDI quattro (110 kW)	S3 2.0 TFSI quattro (221 kW)
Engine type		4-cylinder inline diesel engine with common rail injection system, turbocharging and indirect intercooling	4-cylinder inline diesel engine with common rail injection system, turbocharging and indirect intercooling	4-cylinder inline diesel engine with common rail injection system, turbocharging and indirect intercooling	4-cylinder inline petrol engine with direct fuel injection, turbocharging and intercooling
Displacement in cc ³ (valves per cylinder)		1598 (4)	1968 (4)	1968 (4)	1984 (4)
Max. output ¹ in kW at rpm		77/3000-4000	110/3500-4000	110/3500-4000	221/5600-6200
Max. torque in Nm at rpm		250/1500-2750	320/1750-3000	320/1750-3000	380/1800-5500
Power transmission/wheels					
Drive type		Front-wheel drive	Front-wheel drive	quattro® permanent all-wheel drive	quattro® permanent all-wheel drive
Transmission type		6-speed manual transmission [7-speed S tronic]	6-speed manual transmission [6-speed S tronic]	6-speed manual transmission	6-speed manual transmission [6-speed S tronic]
Wheels ²		Steel wheels, 6.5 J x 16	Steel wheels, 6.5 J x 16	Steel wheels, 6.5 J x 16	Cast aluminium wheels, 7.5 J x 18
Tyres ²		205/55 R 16	205/55 R 16	205/55 R 16	225/40 R 18
Weights/capacities					
Unladen weight ³ in kg		1305 [1325]	A3 1355 [1370] A3 Sportback 1385	1435	1470 [1490]
Gross vehicle weight in kg		1790 [1810]	1840 [1855] 1870	1920	1955 [1975]
Permissible roof load limit/nose weight in kg		75/75 [75/75]	75/75 [75/75] 75/75	75/75	75/- [75/-]
Trailer load limit ⁴ in kg	unbraked	650 [660]	670 [680] 690	710	- [-]
	12 % gradient	1500 [1500]	1600 [1600] 1600	1800	- [-]
	8 % gradient	1700 [1700]	1800 [1800] 1800	1800	- [-]
Fuel tank capacity, approx. in l		50 [50]	50 [50] 50	50	55 [55]
Performance/consumption⁵					
Top speed in km/h		195 [195]	216 [213] 216	214	250 ⁶ [250 ⁶]
Acceleration 0-100 km/h in s		10.7 [10.7]	8.6 [8.3] 8.7	8.4	5.4 [5.1]
Fuel grade		Sulphur-free diesel ⁸	Sulphur-free diesel ⁸	Sulphur-free diesel ⁸	Sulphur-free super plus RON 98 ⁹
Fuel consumption ¹⁰ in l/100 km	urban	4.6 [4.8]	4.9 [5.2] 5.0	5.7	9.1 [8.8]
	extra-urban	3.3 [3.4]	3.6 [4.0] 3.7	4.1	5.8 [5.9]
	combined	3.8 [3.9]	4.1 [4.4] 4.2	4.7	7.0 [6.9]
CO ₂ emissions ¹⁰ in g/km	urban	121 [125]	128 [136] 128	149	209 [202]
	extra-urban	86 [89]	94 [105] 96	107	135 [136]
	combined	99 [102]	106 [117] 108	122	162 [159]
Emission standard		EU5	EU5	EU5	EU6

Notes

- ¹ The figure given was calculated using the specified measuring procedure (current version of Directive 80/1269/EEC).
- ² For Ambition: cast aluminium wheels, size 7.5 J x 17 with 225/45 R 17 tyres.
For Ambiente: cast aluminium wheels, size 7 J x 16 with 205/55 R 16 tyres.
- ³ Unladen vehicle weight includes driver (68 kg), 7 kg of luggage and fuel tank 90 % full, calculated in accordance with the current version of EC Directive 92/21/EEC. Optional equipment may increase the car's unladen weight and drag coefficient, whereupon the possible payload limit and the top speed will be reduced accordingly.
- ⁴ The engine's power output always decreases with increasing altitude. At 1,000 m above sea level, and for every additional 1,000 m, deduct 10 % from the weight of the outfit (trailer load limit + gross weight of the towing vehicle). Figure for trailer load limit applies to factory-fitted trailer towing hitch. If using the vehicle with a trailer towing hitch for commercial purposes, a digital tachograph may be required under certain conditions.
- ⁵ A vehicle's fuel consumption and CO₂ emissions do not just depend on how efficiently the vehicle uses the fuel, but are also influenced by driving behaviour and other non-technical factors. CO₂ is the greenhouse gas primarily responsible for global warming.
- ⁶ Regulated.
- ⁷ We recommend using sulphur-free super unleaded RON 95 in accordance with DIN EN 228. If this is not available, use sulphur-free regular unleaded RON 91 in accordance with DIN EN 228; power output will be slightly reduced. Unleaded RON 95 fuel with a maximum ethanol content of 10 % (E10) can generally be used. Fuel consumption details refer to operation with RON 95 fuel in accordance with 692/2008/EC.
- ⁸ We recommend using sulphur-free diesel in accordance with DIN EN 590. If this is not available, use diesel in accordance with DIN EN 590.
- ⁹ We recommend using sulphur-free super plus unleaded RON 98 in accordance with DIN EN 228. If this is not available, use sulphur-free super unleaded RON 95 in accordance with DIN EN 228; power output will be slightly reduced. Unleaded RON 95 fuel with a maximum ethanol content of 10 % (E10) can generally be used. Fuel consumption details refer to operation with RON 95 fuel in accordance with 692/2008/EC.
- ¹⁰ The figures given were calculated using the specified measuring procedures. The figures do not refer to one individual vehicle and do not form part of any offer, but rather should be used purely for purposes of comparison between the different vehicle models.

Important note

Inspections are due as shown by the service display.

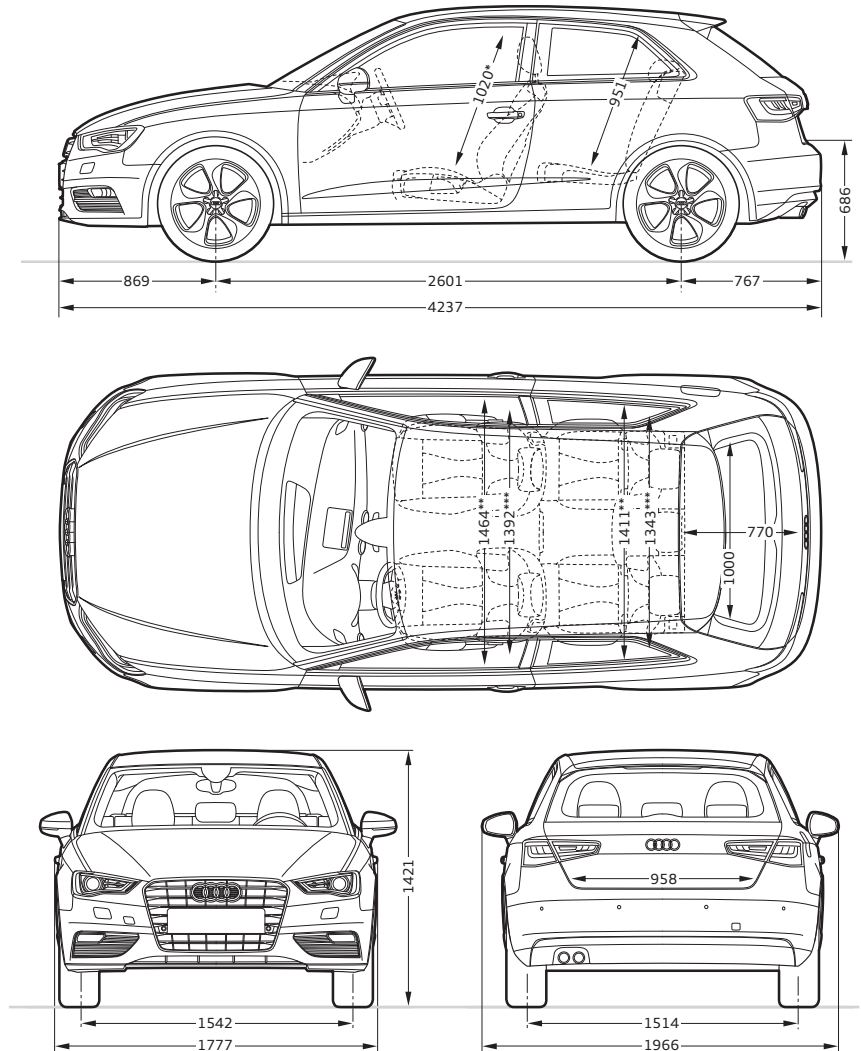
Audi A3**Dimensions in millimetres.**

Dimensions were measured with vehicle at unladen weight.

Luggage compartment volume 365/1100 l (measured by the VDA method using 200 x 100 x 50 mm blocks; second value is with the rear seat backrest folded down and the vehicle loaded up to roof height).

Turning circle approx. 10.7 m.

* Maximum headroom. ** Elbow room width. *** Shoulder room width.

Audi A3 Sportback

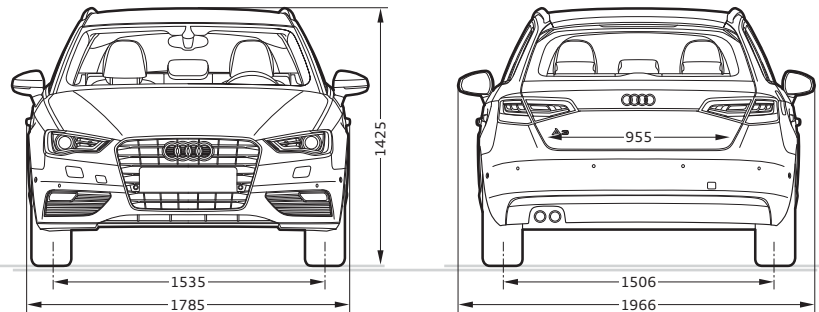
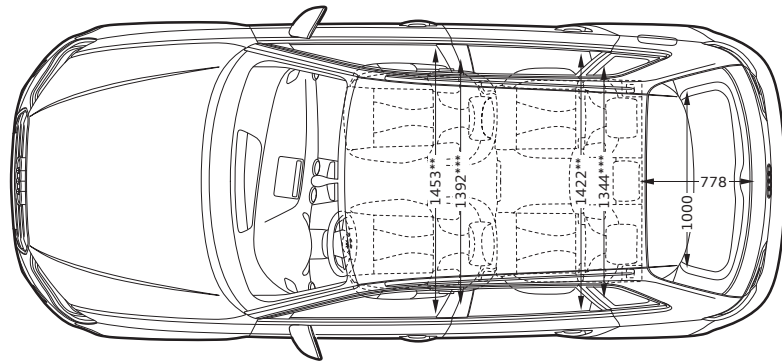
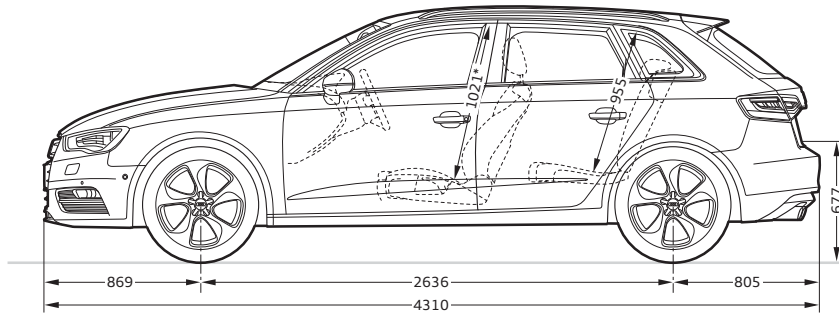

Dimensions in millimetres.

Dimensions were measured with vehicle at unladen weight.

Luggage compartment volume 380/1220 l (measured by the VDA method using 200 x 100 x 50 mm blocks; second value is with the rear seat backrest folded down and the vehicle loaded up to roof height).

Turning circle approx. 10.9 m.

* Maximum headroom. ** Elbow room width. *** Shoulder room width.

Audi S3

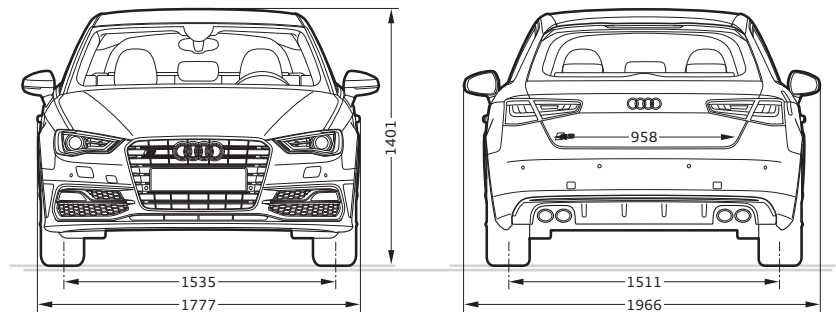
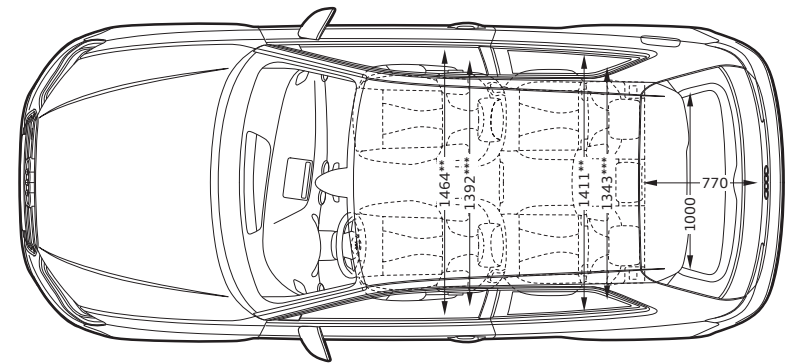
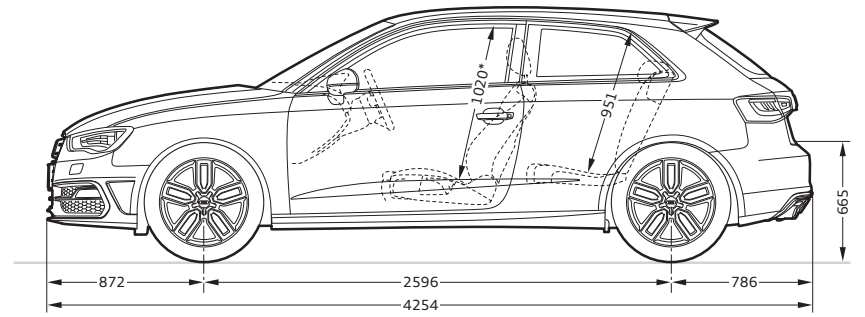

















Dimensions in millimetres.









Dimensions were measured with vehicle at unladen weight.

Luggage compartment volume 365/1100 l (measured by the VDA method using 200 x 100 x 50 mm blocks; second value is with the rear seat backrest folded down and the vehicle loaded up to roof height).

Turning circle approx. 10.7 m.







* Maximum headroom. ** Elbow room width. *** Shoulder room width.























	Page	A3/A3 Sportback Attraction	A3/A3 Sportback Ambition	A3/A3 Sportback Ambiente	S3
Solid paint finishes	88				
 Amalfi white		<input type="checkbox"/>	<input type="checkbox"/>	<input type="checkbox"/>	<input type="checkbox"/>
 Brilliant red		<input type="checkbox"/>	<input type="checkbox"/>	<input type="checkbox"/>	<input type="checkbox"/>
 Brilliant black		<input type="checkbox"/>	<input type="checkbox"/>	<input type="checkbox"/>	<input type="checkbox"/>
Metallic paint finishes	88				
 Ice silver, metallic		<input checked="" type="checkbox"/>	<input checked="" type="checkbox"/>	<input checked="" type="checkbox"/>	<input checked="" type="checkbox"/>
 Monsoon grey, metallic		<input checked="" type="checkbox"/>	<input checked="" type="checkbox"/>	<input checked="" type="checkbox"/>	<input checked="" type="checkbox"/>
 Dakota grey, metallic		<input checked="" type="checkbox"/>	<input checked="" type="checkbox"/>	<input checked="" type="checkbox"/>	<input checked="" type="checkbox"/>
 Beluga brown, metallic		<input checked="" type="checkbox"/>	<input checked="" type="checkbox"/>	<input checked="" type="checkbox"/>	<input checked="" type="checkbox"/>
 Glacier white, metallic		<input checked="" type="checkbox"/>	<input checked="" type="checkbox"/>	<input checked="" type="checkbox"/>	<input checked="" type="checkbox"/>
 Shiraz red, metallic		<input checked="" type="checkbox"/>	<input checked="" type="checkbox"/>	<input checked="" type="checkbox"/>	<input checked="" type="checkbox"/>
 Scuba blue, metallic		<input checked="" type="checkbox"/>	<input checked="" type="checkbox"/>	<input checked="" type="checkbox"/>	<input checked="" type="checkbox"/>
Pearl effect paint finishes	89				
 Misano red, pearl effect		<input checked="" type="checkbox"/>	<input checked="" type="checkbox"/>	<input checked="" type="checkbox"/>	<input checked="" type="checkbox"/>
 Phantom black, pearl effect		<input checked="" type="checkbox"/>	<input checked="" type="checkbox"/>	<input checked="" type="checkbox"/>	<input checked="" type="checkbox"/>
Crystal effect paint finishes	89				
 Estoril blue, crystal effect		<input type="checkbox"/>	<input type="checkbox"/>	<input type="checkbox"/>	<input checked="" type="checkbox"/>
 Panther black, crystal effect		<input type="checkbox"/>	<input type="checkbox"/>	<input type="checkbox"/>	<input checked="" type="checkbox"/>
Audi exclusive customised paint finishes	89				
 Audi exclusive customised paint finishes ¹		<input checked="" type="checkbox"/>	<input checked="" type="checkbox"/>	<input checked="" type="checkbox"/>	<input checked="" type="checkbox"/>
Wheels/tyres	90				
 16" steel wheels including full wheel covers		<input type="checkbox"/>	<input type="checkbox"/>	<input type="checkbox"/>	<input type="checkbox"/>
 16" cast aluminium wheels in 10-spoke design		<input checked="" type="checkbox"/>	<input checked="" type="checkbox"/>	<input checked="" type="checkbox"/>	<input type="checkbox"/>

	Page	A3/A3 Sportback Attraction	A3/A3 Sportback Ambition	A3/A3 Sportback Ambiente	S3
 16" cast aluminium wheels in 15-spoke Y design		<input type="checkbox"/>	<input type="checkbox"/>	<input type="checkbox"/>	<input type="checkbox"/>
 17" cast aluminium wheels in 5-arm design		<input type="checkbox"/>	<input type="checkbox"/>	<input type="checkbox"/>	<input type="checkbox"/>
 17" cast aluminium wheels in 5-arm kinetic design		<input checked="" type="checkbox"/>	<input checked="" type="checkbox"/>	<input checked="" type="checkbox"/>	<input type="checkbox"/>
 17" cast aluminium wheels in 15-spoke design		<input checked="" type="checkbox"/>	<input checked="" type="checkbox"/>	<input checked="" type="checkbox"/>	<input type="checkbox"/>
 17" Audi exclusive cast aluminium wheels in 5-twin-spoke design		<input checked="" type="checkbox"/>	<input checked="" type="checkbox"/>	<input checked="" type="checkbox"/>	<input type="checkbox"/>
 18" cast aluminium wheels in 5-arm dynamic design		<input checked="" type="checkbox"/>	<input checked="" type="checkbox"/>	<input checked="" type="checkbox"/>	<input type="checkbox"/>
 18" cast aluminium wheels in 5-parallel-spoke design (S design)		<input type="checkbox"/>	<input type="checkbox"/>	<input type="checkbox"/>	<input type="checkbox"/>
 18" cast aluminium wheels in 5-twin-spoke star design (S design)		<input type="checkbox"/>	<input type="checkbox"/>	<input type="checkbox"/>	<input checked="" type="checkbox"/>
 18" Audi exclusive cast aluminium wheels in 5-arm rotor design in black, high-gloss turned finish		<input checked="" type="checkbox"/>	<input checked="" type="checkbox"/>	<input checked="" type="checkbox"/>	<input checked="" type="checkbox"/>

Standard equipment Optional equipment not available

Country-specific variations possible. Please find out from your local Audi partner which equipment is standard and what optional equipment is available in your country.

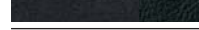







	Page	A3/A3 Sportback Attraction	A3/A3 Sportback Ambition	A3/A3 Sportback Ambiente	S3
 18" Audi exclusive cast aluminium wheels in 10-spoke design ¹		■	■	■	■
 16" steel winter wheels including full wheel covers		■	■	■	—
 16" cast aluminium winter wheels in 10-spoke design		■	■	■	—
 17" cast aluminium winter wheels in 5-arm design		■	■	■	■
 18" cast aluminium winter wheels in 5-arm dynamic design		■	■	■	—
 18" cast aluminium winter wheels in 5-parallel-spoke design (S design)		—	—	—	■
Anti-theft wheel bolts		■	■	■	■
Tyre repair kit		□	□	□	□
Tyre pressure loss indicator		■	■	■	■
Vehicle tool kit		□	□	□	□
Vehicle jack ²		■	■	■	■
Spare wheel, space-saving		■	■	■	■
Run-flat tyres		■	■	■	—
Seats	92				
Standard seats, front		□	—	□	—
Sport seats, front		■	□	■	□

	Page	A3/A3 Sportback Attraction	A3/A3 Sportback Ambition	A3/A3 Sportback Ambiente	S3
S sport seats, front		■ ³	■ ³	■ ³	■
Seat upholstery for standard seats, front	92				
 Marathon cloth, black		□	—	—	—
 Marathon cloth, titanium grey		□	—	—	—
 Regatta cloth/mono.pur, black		—	—	□	—
 Regatta cloth/mono.pur, titanium grey		—	—	□	—
 Regatta cloth/mono.pur, pashmina beige		—	—	□	—
 Regatta cloth/mono.pur, chestnut brown		—	—	□	—
 Milano leather, black		■	—	■	—
 Milano leather, pashmina beige		■	—	■	—
 Audi exclusive leather upholstery and trim ¹		■	—	■	—
Seat upholstery for sport seats, front	94				
 Rallye cloth, black/black		—	□	—	—
 Rallye cloth, black/silver		—	□	—	—
 Rallye cloth, black/blue		—	□	—	—
 Rallye cloth, black/yellow		—	□	—	—
 Trophy cloth/leather		—	—	—	□
 Milano leather, black		■	■	■	—
 Milano leather, titanium grey		■	■	■	—
 Milano leather, chestnut brown		■	■	■	—
 Audi design selection Capri orange		—	■	—	—
 Audi design selection parade red		—	—	—	■
 Alcantara/leather, black		■	■	■	■
 Alcantara/leather, titanium grey		■	■	■	—
 Alcantara/leather, black/lunar silver		—	—	—	■
 Fine Nappa leather, black		—	■ ³	—	■
 Fine Nappa leather, lunar silver		—	—	—	■

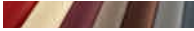
¹For information on when this feature will be available, please contact your Audi partner.

²Standard in conjunction with space-saving spare wheel or in conjunction with winter wheels.

³Only available in conjunction with S line sport package.

	Page	A3/A3 Sportback Attraction	A3/A3 Sportback Ambition	A3/A3 Sportback Ambiente	S3
 Audi exclusive leather upholstery and trim ¹		■	■	■	■
Seat upholstery for S sport seats, front	97				
 Fine Nappa leather, black		—	■ ²	—	■
 Audi exclusive leather upholstery and trim ¹		—	■ ²	—	■
Cloth/leather upholstery and trim	98				
Marathon cloth		□	—	—	—
Regatta cloth/mono.pur		—	—	□	—
Rallye cloth		—	□	—	—
Trophy cloth/leather		—	—	—	□
Alcantara/leather combination		■	■	■	■
Milano leather upholstery and trim		■	■	■	—
Fine Nappa leather		—	■ ²	—	■
Audi design selection Capri orange		—	■	—	—
Audi design selection parade red		—	—	—	■
Audi exclusive leather upholstery and trim in Alcantara/fine Nappa leather ¹		■	■	■	■
Audi exclusive leather upholstery and trim in fine Nappa leather ¹		■	■	■	■
Audi exclusive extended leather upholstery and trim ¹		■	■	■	■
Extended interior elements mono.pur		■	■	■	■
Headlinings	98				
Headlining in lunar silver cloth		□	□	□	■
Headlining in black cloth		■	■	■	□
Inlays	99				
 Micrometallic, silver		□	□	—	—
 3D-design "Optic"		■	■	□	—
 Aluminium mistral		■	■	■	—
 Matt brushed aluminium		—	■ ³	—	□
 3D-design "Black"		—	■ ²	—	■

□ Standard equipment ■ Optional equipment — not available

Country-specific variations possible. Please find out from your local Audi partner which equipment is standard and what optional equipment is available in your country.

	Page	A3/A3 Sportback Attraction	A3/A3 Sportback Ambition	A3/A3 Sportback Ambiente	S3
Lights	100				
LED headlights ¹		—	—	—	■
xenon plus including headlight cleaning system		■	■	■	□
Headlights		□	□	□	—
Headlight cleaning system ⁴		■	■	■	□
Front fog lights		■	□	■	—
LED rear lights ⁵		■	■	■	□
Rear lights		□	□	□	—
adaptive light		■	■	■	■
Variable headlight range control ⁶		■	■	■	■
High-beam assist		■	■	■	■
Adaptive brake light		□	□	□	□
Interior lighting		□	□	□	□
Lighting package		■	■	□	■
Light/rain sensor		■	■	■	■
Mirrors	101				
Exterior mirrors with integrated LED indicator		□	□	□	□
Exterior mirrors, heated		■	■	■	■
Exterior mirrors, heated and electrically folding		■	■	■	■
Exterior mirrors, heated, electrically folding and automatically dimming on the driver side		■	■	■	■
Interior mirror, dimming		□	□	□	□
Interior mirror, automatically dimming		■	■	■	■
Illuminated vanity mirror		■	■	□	□
Roof systems	101				
Panoramic glass sunroof		■	■	■	■
Roof rails, anodised ⁷		■	■	■	—
Roof rails, black ⁷		■	■	■	—

	Page	A3/A3 Sportback Attraction	A3/A3 Sportback Ambition	A3/A3 Sportback Ambiente	S3
Closing systems	102				
Remote control key		<input type="checkbox"/>	<input type="checkbox"/>	<input type="checkbox"/>	<input type="checkbox"/>
Convenience key		<input checked="" type="checkbox"/>	<input checked="" type="checkbox"/>	<input checked="" type="checkbox"/>	<input checked="" type="checkbox"/>
Electronic immobiliser		<input type="checkbox"/>	<input type="checkbox"/>	<input type="checkbox"/>	<input type="checkbox"/>
Anti-theft alarm		<input checked="" type="checkbox"/>	<input checked="" type="checkbox"/>	<input checked="" type="checkbox"/>	<input checked="" type="checkbox"/>
Preparation for tracking system		<input checked="" type="checkbox"/>	<input checked="" type="checkbox"/>	<input checked="" type="checkbox"/>	<input checked="" type="checkbox"/>
Glazing	102				
Acoustic windscreen		<input type="checkbox"/>	<input type="checkbox"/>	<input type="checkbox"/>	<input type="checkbox"/>
Rear window		<input type="checkbox"/>	<input type="checkbox"/>	<input type="checkbox"/>	<input type="checkbox"/>
Dark-tinted windows (privacy glazing)		<input checked="" type="checkbox"/>	<input checked="" type="checkbox"/>	<input checked="" type="checkbox"/>	<input checked="" type="checkbox"/>
Windscreen cleaning system		<input type="checkbox"/>	<input type="checkbox"/>	<input type="checkbox"/>	<input type="checkbox"/>
Sun visors		<input type="checkbox"/>	<input type="checkbox"/>	<input type="checkbox"/>	<input type="checkbox"/>
Further exterior equipment	102				
S line roof edge spoiler		<input checked="" type="checkbox"/>	<input checked="" type="checkbox"/>	<input checked="" type="checkbox"/>	<input type="checkbox"/>
Roof edge spoiler		<input type="checkbox"/>	<input type="checkbox"/>	<input type="checkbox"/>	<input type="checkbox"/>
S3 roof edge spoiler		<input type="checkbox"/>	<input type="checkbox"/>	<input type="checkbox"/>	<input type="checkbox"/>
Model/technology name		<input type="checkbox"/>	<input type="checkbox"/>	<input type="checkbox"/>	<input type="checkbox"/>
Audi Singleframe		<input type="checkbox"/>	<input type="checkbox"/>	<input type="checkbox"/>	<input type="checkbox"/>
Exhaust tailpipes		<input type="checkbox"/>	<input type="checkbox"/>	<input type="checkbox"/>	<input type="checkbox"/>
Bumpers		<input type="checkbox"/>	<input type="checkbox"/>	<input type="checkbox"/>	<input type="checkbox"/>
High-gloss package		<input checked="" type="checkbox"/>	<input checked="" type="checkbox"/>	<input type="checkbox"/>	<input checked="" type="checkbox"/>
Provision for trailer towing hitch		<input checked="" type="checkbox"/>	<input checked="" type="checkbox"/>	<input checked="" type="checkbox"/>	<input type="checkbox"/>
Trailer towing hitch		<input checked="" type="checkbox"/>	<input checked="" type="checkbox"/>	<input checked="" type="checkbox"/>	<input type="checkbox"/>
Seats/seating comfort	103				
Convenience entry ⁸		<input type="checkbox"/>	<input type="checkbox"/>	<input type="checkbox"/>	<input type="checkbox"/>
4-way lumbar support for the front seats		<input checked="" type="checkbox"/>	<input checked="" type="checkbox"/>	<input checked="" type="checkbox"/>	<input checked="" type="checkbox"/>
Front-passenger seat with height adjustment		<input type="checkbox"/>	<input type="checkbox"/>	<input type="checkbox"/>	<input type="checkbox"/>

	Page	A3/A3 Sportback Attraction	A3/A3 Sportback Ambition	A3/A3 Sportback Ambiente	S3
Driver seat, electrically adjustable ⁷		<input checked="" type="checkbox"/>	<input checked="" type="checkbox"/>	<input checked="" type="checkbox"/>	<input type="checkbox"/>
Front seats, electrically adjustable ⁷		<input checked="" type="checkbox"/>	<input checked="" type="checkbox"/>	<input checked="" type="checkbox"/>	<input type="checkbox"/>
Rear seat backrest, folding		<input type="checkbox"/>	<input type="checkbox"/>	<input type="checkbox"/>	<input type="checkbox"/>
Seat heating, front		<input checked="" type="checkbox"/>	<input checked="" type="checkbox"/>	<input checked="" type="checkbox"/>	<input checked="" type="checkbox"/>
Centre armrest, front		<input checked="" type="checkbox"/>	<input checked="" type="checkbox"/>	<input type="checkbox"/>	<input type="checkbox"/>
ISOFIX child seat mounting for the front-passenger seat		<input checked="" type="checkbox"/>	<input checked="" type="checkbox"/>	<input checked="" type="checkbox"/>	<input checked="" type="checkbox"/>
ISOFIX child seat mounting and Top Tether for the outer rear seats		<input type="checkbox"/>	<input type="checkbox"/>	<input type="checkbox"/>	<input type="checkbox"/>
Steering wheels/gear levers/controls	103				
Leather-covered steering wheel in 4-spoke design		<input checked="" type="checkbox"/>	<input type="checkbox"/>	<input type="checkbox"/>	<input type="checkbox"/>
Steering wheel in 4-spoke design		<input type="checkbox"/>	<input type="checkbox"/>	<input type="checkbox"/>	<input type="checkbox"/>
Leather-covered sport steering wheel in 3-spoke design		<input type="checkbox"/>	<input type="checkbox"/>	<input type="checkbox"/>	<input type="checkbox"/>
Leather-covered multifunction steering wheel in 4-spoke design		<input checked="" type="checkbox"/>	<input type="checkbox"/>	<input checked="" type="checkbox"/>	<input type="checkbox"/>
Leather-covered multifunction sport steering wheel in 3-spoke design		<input type="checkbox"/>	<input checked="" type="checkbox"/>	<input type="checkbox"/>	<input type="checkbox"/>
Leather-covered multifunction sport steering wheel in 3-spoke design, flattened at the bottom		<input type="checkbox"/>	<input checked="" type="checkbox"/>	<input type="checkbox"/>	<input checked="" type="checkbox"/>
Audi exclusive leather steering wheel rim ¹		<input checked="" type="checkbox"/>	<input checked="" type="checkbox"/>	<input checked="" type="checkbox"/>	<input checked="" type="checkbox"/>
Audi exclusive leather controls ¹		<input checked="" type="checkbox"/>	<input checked="" type="checkbox"/>	<input checked="" type="checkbox"/>	<input checked="" type="checkbox"/>
Audi exclusive aluminium gear lever knob ¹		<input checked="" type="checkbox"/>	<input checked="" type="checkbox"/>	<input checked="" type="checkbox"/>	<input checked="" type="checkbox"/>
Climate control	104				
Manual air conditioning		<input type="checkbox"/>	<input type="checkbox"/>	<input type="checkbox"/>	<input type="checkbox"/>
Auxiliary heating/ventilation ¹		<input checked="" type="checkbox"/>	<input checked="" type="checkbox"/>	<input checked="" type="checkbox"/>	<input type="checkbox"/>
Deluxe automatic air conditioning		<input checked="" type="checkbox"/>	<input checked="" type="checkbox"/>	<input checked="" type="checkbox"/>	<input type="checkbox"/>
Ventilation system and heating		<input type="checkbox"/>	<input type="checkbox"/>	<input type="checkbox"/>	<input type="checkbox"/>
Luggage securing and storage systems	105				
Storage and luggage compartment package		<input checked="" type="checkbox"/>	<input checked="" type="checkbox"/>	<input checked="" type="checkbox"/>	<input type="checkbox"/>
Storage compartments		<input type="checkbox"/>	<input type="checkbox"/>	<input type="checkbox"/>	<input type="checkbox"/>
Clothes hooks		<input type="checkbox"/>	<input type="checkbox"/>	<input type="checkbox"/>	<input type="checkbox"/>
Luggage compartment cover		<input type="checkbox"/>	<input type="checkbox"/>	<input type="checkbox"/>	<input type="checkbox"/>

¹For information on when this feature will be available, please contact your Audi partner. ²Only available in conjunction with S line sport package. ³Standard in conjunction with S line sport package.

⁴Component of xenon plus including headlight cleaning system. ⁵Component of xenon plus including headlight cleaning system or LED headlights. ⁶Only available in conjunction with adaptive light and Audi active lane assist.

⁷Only available for A3 Sportback. ⁸Only available for A3 and S3.

	Page	A3/A3 Sportback Attraction	A3/A3 Sportback Ambition	A3/A3 Sportback Ambiente	S3
Reversible mat		■	■	■	■
Lashing points		□	□	□	□
Loading floor, two levels		□ ¹	□ ¹	□ ¹	–
Through-loading facility		■	■	■	■
Ski/snowboard bag		■	■	■	■
Further interior equipment	106				
Door sill trims		–	□	□	□
Floor mats, front		□	□	□	□
Floor mats, rear		■	■	■	■
Window controls		□	□	□	□
Aluminium look in the interior		■	■	■	□
Centre console		□	□	□	□
Cigarette lighter and ashtrays		■	■	■	■
12V socket		□	□	□	□
Mobile phone/key holder ²		■	■	■	■
Grab handles		□	□	□	□
MMI® and navigation systems	107				
MMI® navigation plus with MMI touch		■	■	■	■
Navigation package		■	■	■	■
Navigation data (SD card)		■	■	■	■
Driver information system (monochrome display)		■	–	–	–
Driver information system (colour display)		■	□	□	□
Radio systems	108				
Audi radio		□	□	□	□
Digital radio reception		■	■	■	■
MMI® radio		■	■	■	■
Audi sound system		■	■	■	■

□ Standard equipment ■ Optional equipment – not available

Country-specific variations possible. Please find out from your local Audi partner which equipment is standard and what optional equipment is available in your country.

	Page	A3/A3 Sportback Attraction	A3/A3 Sportback Ambition	A3/A3 Sportback Ambiente	S3
Bang & Olufsen Sound System		■	■	■	■
Audi music interface		■	■	■	■
Adapter cable set for Audi music interface		■	■	■	■
Adapter cable set plus for Audi music interface		■	■	■	■
Telephone and communication	109				
Audi phone box		■	■	■	■
Bluetooth interface		■	■	■	■
Audi connect		■	■	■	■
Connectivity package		■	■	■	■
Assistance systems	110				
Audi active lane assist		■	■	■	■
Camera-based traffic sign recognition		■	■	■	■
Audi side assist		■	■	■	■
adaptive cruise control		■	■	■	■
Assistance package		■	■	■	■
Hold assist		■	■	■	■
Cruise control		■	■	□	■
Audi pre sense basic		■	■	■	■
Parking system, rear		■	■	□	■
Parking system plus with selective display		■	■	■	■
Park assist with selective display		■	■	■	■
Rearview camera		■	■	■	■
Suspensions/brakes	111				
Dynamic suspension		□	■	□	–
Sport suspension		■	□	■	–
S sport suspension		–	–	–	□
S line sport suspension		■	■	■	–

	Page	A3/A3 Sportback Attraction	A3/A3 Sportback Ambition	A3/A3 Sportback Ambiente	S3
Audi magnetic ride		■	■	■	■
Audi drive select		■	□	■	□
Electromechanical parking brake		□	□	□	□
Brake system		□	□	□	□
Secondary collision brake assist		□	□	□	□
Progressive steering		■ ³	■ ³	■ ³	□
Technology/safety	112				
Body		□	□	□	□
Side impact protection		□	□	□	□
Full-size airbags		□	□	□	□
Side airbags, front		□	□	□	□
Side airbags, rear		■ ⁴	■ ⁴	■ ⁴	–
Head airbag system		□	□	□	□
Knee airbag		□	□	□	□
Integrated head restraint system		□	□	□	□
Safety steering column		□	□	□	□
Seat belts		□	□	□	□
Seat belt reminder		□	□	□	□
Warning and control lights		□	□	□	□
Warning triangle		□	□	□	□
First-aid kit		□	□	□	□
Electromechanical power steering		□	□	□	□
Electronic Differential Lock (EDL)		□	□	□	□
Electronic Stabilisation Control (ESC)		□	□	□	□
Electronic Stabilisation Control (ESC) with electronic axle-differential lock ⁵		□	□	□	–
Anti-Slip Regulation (ASR)		□	□	□	□

	Page	A3/A3 Sportback Attraction	A3/A3 Sportback Ambition	A3/A3 Sportback Ambiente	S3
Manual transmission		□	□	□	□
S tronic®		■	■	■	■
Front-wheel drive		□	□	□	–
quattro®		■ ⁶	■ ⁶	■ ⁶	□
Diesel particulate filter, additive-free ⁷		□	□	□	–
Start-stop system		□	□	□	□
Recuperation		□	□	□	□
Coasting mode ⁸		■	■	■	■
Audi Extended Warranty	113				
Audi Extended Warranty		■	■	■	■

Equipment for the Audi A3 illustrated (p. 4–29, 42–43):

Paint finish: ice silver, metallic

Wheels: cast aluminium wheels in 5-arm dynamic design, anthracite, partly polished, size 7.5 J x 18 with 225/40 R 18 tyres

Seat upholstery: Milano leather, chestnut brown

Inlays: aluminium mistral

Equipment for the Audi A3 Sportback illustrated (p. 4–29, 42–43):

Paint finish: glacier white, metallic

Wheels: cast aluminium wheels in 15-spoke design, size 7.5 J x 17 with 225/45 R 17 tyres

Seat upholstery: Milano leather, titanium grey

Inlays: aluminium mistral

Equipment for the Audi S3 illustrated (p. 30–43):

Paint finish: Misano red, pearl effect

Wheels: cast aluminium wheels in 5-parallel-spoke design (S design), partly polished, size 7.5 J x 18 with 225/40 R 18 tyres

Seat upholstery: fine Nappa leather, black (shoulder area in fine Nappa leather embroidered with contrasting stitching)

Inlays: matt brushed aluminium

¹ Not available with quattro or trailer towing hitch in conjunction with Bang & Olufsen Sound System or Audi sound system. ² For information on when this feature will be available, please contact your Audi partner. ³ For information on when this feature will be available, please contact your Audi partner. Für 1.6 TDI (77 kW) not available. ⁴ Only available for A3 Sportback. ⁵ Only on models with front-wheel drive. ⁶ For information on when this feature will be available for the A3 Sportback, please contact your Audi partner. ⁷ Only available for diesel motors. ⁸ Standard for vehicles with S tronic and Audi drive select.

At Audi, you get much more than just an Audi.

Anyone who chooses an Audi chooses a brand that offers its customers more. More individuality. More exclusivity. And more fascination.



www.audi.com

Vorsprung durch Technik, and everything that it entails: the legendary Audi history, dates of unforgettable events and ground-breaking innovations – let your fascination grow with the Audi brand.

> www.audi.com



Audi configurator

Create your own personal Audi using the Audi configurator. All current models, engines, colours and equipment options are available for you to choose from.

> www.audi.com

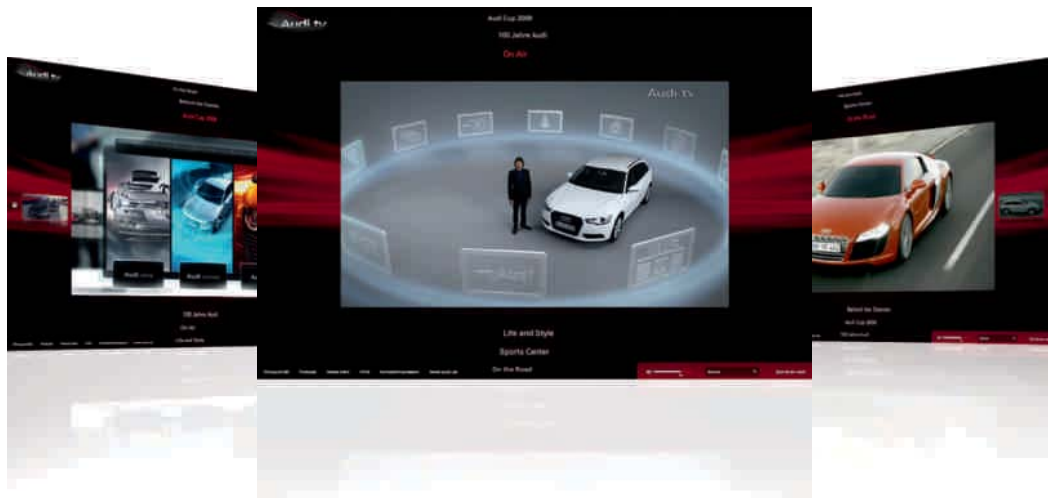

Audi tv

On Audi tv you can discover new facets of our brand with the four rings: exciting commentaries on our models, technical innovations, fascinating events from the fields of motorsport, tradition, culture and lifestyle. Take a look behind the scenes. The latest news every day. Round the clock.

> www.audi.tv



Audi Bank

Financing. Leasing. Insuring. Whichever new Audi you decide on, every quotation from the Audi Bank is individually tailored to you: Our special offer packages, for example, combine current financing and leasing options with comprehensive insurance protection and thus offer you unlimited mobility.

> www.audi.com



AUDI AG
85045 Ingolstadt
www.audi.com
Valid from September 2012

Printed in Germany
233/1230.32.18

The models and equipment versions illustrated and described in this brochure and some of the services listed are not available in all countries. Some of the cars illustrated are equipped with optional features for which an extra charge is made. Details concerning the delivery specifications, appearance, performance, dimensions and weights, fuel consumption and running costs of the vehicle were correct to the best of our knowledge at the time of going to press. Deviations from the colours and shapes shown in the illustrations may occur. No liability is accepted for errors and printing errors. The right to introduce modifications is reserved. Not to be reproduced, including in part, without the written approval of AUDI AG.

This brochure is printed on paper made from pulp bleached without the use of chlorine.