

# VXR

2014 Models Edition 1



Proud Sponsor of Home Nations Football





# VXR NEW LIMITS

**This is extra-sensory stimulation.** Cars with soul and power to make you feel alive, electrified and inspired. A range of driver-focused, performance machines that just demand to be driven.

This brochure covers Corsa VXR, Corsa VXR Clubsport, Astra VXR, New Insignia VXR SuperSport and New VXR8 models only. Some of the models shown include options and accessories available at extra cost. And not all of the features described are available on every model. So for all current model or equipment details visit: [www.vxr.co.uk](http://www.vxr.co.uk)  
The colours reproduced throughout this brochure may vary slightly from the actual paint colour. As a result, they should be used as a guide only. Your Vauxhall Retailer has a comprehensive display of our paint samples.

## VXR RANGE

Live the Change	4
Corsa VXR	6
Corsa VXR Clubsport	12
Astra VXR	16
New Insignia VXR SuperSport	22
Corsa, Astra, New Insignia Technical Guide	30
Corsa, Astra, New Insignia Options	36
New VXR8	38
New VXR8 Clubsport R8 and Maloo R8	46
New VXR8 Enhanced Driver Interface	48
New VXR8 Chassis Dynamics	50
VXR Colours and Trims	52

# VXR LIVE THE CHANGE

Advances in automotive technology have diluted the modern driving experience to the point where many of today's 'performance' cars have become soulless and uncommunicative.

You feel like you're not actually driving. You feel like you're being driven: you feel disconnected.

VXR changes all that. VXR is here to reconnect the driver to the road – not with a wire, but with a heartbeat. There's a range of VXR models, every one a focused performance machine, the kind you want to be driving if you like to get up in the night for a blast, just for the hell of it. If you are that type of person, then you've got VXR in your blood. You just might not know it yet.





# CORSA VXR

**The power to reach 60mph in just 6.5\* seconds.**

The ability to stay in control from a dynamic sports chassis set-up. The reassurance that comes from a range of serious safety features. Choose your weapon – VXR or the new VXR Clubsport model. All you need do is point and shoot.

18-inch alloy wheels and Adaptive Forward Lighting are optional at extra cost.  
\*VXR Clubsport models.





VXR

# SERIOUSLY INVOLVING

You don't just get into the Corsa VXR. You tune in. Every aspect, detail and material exists for one reason alone. To connect you to the road.

## Interior features

- Recaro shell-backed sports front seats with Morrocana-trimmed side bolsters and integral head restraints
- Driver's and front passenger's front, side-impact and curtain airbags
- Three-spoke flat-bottomed leather-covered sports steering wheel with VXR logo
- Unique VXR instrument panel with stepper motor speedometer and tachometer
- Unique VXR gear knob
- Sports pedals
- VXR alloy-effect door sill covers
- CD/MP3 CD player/aux-in/stereo radio (CD 30 MP3)
- Remote control security alarm system
- Air conditioning
- Cruise control
- Trip computer





**1. Recaro seats.** Corsa VXR comes with height-adjustable, 'shell-backed' Recaro VXR sports front seats to keep you in place when the going gets a little quick. They provide just the support you need right where you need it. And they look pretty awesome too.

**2. VXR fascia.** Think of it as VXR mission control. This is where it all happens if you're a Corsa VXR driver. Black sports instruments with translucent rings and red highlights. Piano black-effect centre console with quality CD 30 MP3 audio and aux-in socket. Illuminated translucent switches. Cruise control. Trip computer. And you.

**3. VXR steering wheel.** You don't stick any old wheel on a car like Corsa VXR. This three-spoke is trimmed in black leather with silver stitching and the audio remote controls in cool Piano black-effect panels. It's flat-bottomed too and has a VXR logo mounted in its own alloy trim.

**4. VXR detailing.** The Corsa VXR interior is packed with VXR-specific details. A leather-trimmed gear knob with VXR logo takes charge of the six-speed gearbox. There are sports pedals, and VXR-logo floor mats and sill covers.

# DESIGNED TO SET THE HEART RACING

The name says it all. The Corsa VXR means business. Just one glance at the honeycomb sports front grille, the rear roof spoiler and the side sills and you know this car promises performance. And under the bonnet it more than delivers. Corsa VXR is capable of 0-60mph in a mere 6.8 seconds thanks to a turbocharged 1.6i 16v engine.

## Exterior features

- VXR rear roof spoiler 1.
- VXR honeycomb sports front grille and air dam/bumper
- VXR front fog lights with alloy-effect surround
- Unique VXR twin-arm door mirrors 2.
- VXR side sills
- VXR rear bumper incorporating diffuser
- VXR triangular centre exit exhaust tailpipe 3.
- Dark-tinted rear windows optional at extra cost

**Design theme.** Corsa VXR's electrically heated door mirrors, front fog light surrounds and centre exit exhaust tailpipe all share a unique triangular design theme.

**Alloy wheels.** The 17-inch Y-design alloy wheel 4 is standard on Corsa VXR with 215/45 R 17 ultra-low profile tyres. And if you fancy something a little wilder, how about the optional 18-inch alloy wheels with 225/35 R 18 ultra-low profile tyres 5. Serious performance and visual impact all in one package.



**Engine, transmission and chassis.** Whichever way you look at it, Corsa VXR doesn't hang around. The lightweight 1.6 litre turbo puts out 192PS and the software controlled overboost increases maximum torque to 260+Nm for safer overtaking. No worries in the chassis department either. With lowered sports suspension, bigger brakes, switchable Electronic Stability Programme (ESP) with traction control and ABS with straight line stability control and cornering brake control – it's all designed for rapid, safe progress.

### Engine

1.6i 16v ECOTEC-4 Turbo (1598cc)

Maximum power:

192PS (141kW) @ 5850rpm

Maximum torque:

230Nm\* (170 lb.ft.) @ 1980-5850rpm

Compression ratio: 8.8:1

Bore/stroke: 79.0mm x 81.5mm

- Turbocharger integrated into exhaust manifold
- Intercooler
- Sodium-filled exhaust valves

\*Increased to 260+Nm for five seconds with turbo overboost function.

### Performance

(manufacturer's figures)

- Maximum speed: 140mph
- Acceleration 0-60mph: 6.8secs

### Fuel economy and emissions

mpg (litres/100km)

- Urban driving: 28.8 (9.8)
- Extra-urban driving: 47.9 (5.9)
- Combined figure: 38.7 (7.3)
- CO<sub>2</sub> emissions: 172g/km

### Chassis, suspension and brakes

- Lowered and uprated VXR sports suspension  see page 31
- Switchable Electronic Stability Programme (ESP) including traction control
- Front ventilated disc brakes: 308mm diameter
- Rear disc brakes: 264mm diameter

### Transmission

- Six-speed manual gearbox
- Gear ratios:  
1st – 3.82:1, 2nd – 2.16:1,  
3rd – 1.48:1, 4th – 1.07:1, 5th – 0.88:1,  
6th – 0.74:1, Final drive – 4.18:1

### Wheels and tyres

- 17-inch Y-design alloy wheels with 215/45 R 17 ultra-low profile tyres
- 18-inch 5 Y-spoke bi-colour alloy wheels with 225/35 R 18 ultra-low profile tyres, optional at extra cost
- Car supplied with emergency tyre inflation kit in lieu of spare wheel



### Insurance group (ABI recommended)

- 32D



18-inch 5 Y-spoke bi-colour alloy wheels with 225/35 R 18 ultra-low profile tyres, optional at extra cost

### Tyre rating (according to EU Regulation 1222/2009)

Tyre size	215/45 R 17	225/35 R 18
Fuel efficiency group	E	E
Wet grip performance	B	B
External noise measured (dB)	75	77
External noise group		

# CORSA VXR CLUBSPORT

**Be in no doubt: the new Corsa VXR Clubsport throws down the challenge to the hot hatch elite and make no mistake it delivers, big time.**

A 205PS 1.6 litre turbocharged engine, Drexler mechanical limited-slip differential, Bilstein developed chassis set up, uprated Remus sports exhaust and high performance Brembo braking say this is one mean Corsa.



**VXR Clubsport Interior.** 'Shell-backed' Recaro sports front seats 1. VXR fascia, steering wheel, gear knob and sports pedals. And driver-focused ergonomics that put you fully in control. The Touch and Connect multi-media satellite navigation system is optional at extra cost. 2. Unique 'Clubsport' black-finish door sill set the tone.



Dark-tinted rear glass, Adaptive Forward Lighting and two-coat metallic paint are optional at extra cost.



**VXR Clubsport Exterior.** The VXR Clubsport signals its sporting intent with a hardcore stainless steel Remus dual exhaust system. 18-inch lightweight black gloss alloy wheels. And serious rubberware: 225/35 R 18 ultra-low profile tyres for massive grip **3**. With 250-280Nm\* of torque and 205PS, VXR Clubsport piles on the performance as cleanly as you like. To harness the power potential, the VXR Clubsport employs a Drexler traction-enhancing mechanical multi-plate limited-slip differential. Brembo four-piston front brakes ensure exceptional stopping ability too **4**.

\*Increased to 280Nm with turbo overboost function.

# ACCELERATE EVERYTHING

**Significant chassis mods – signed off on the Nürburgring's unforgiving Nordschleife no less – ensure there's grip, balance and body control to spare.**

This ultimate Corsa VXR receives specially commissioned progressive-rate springs and inverted monotube dampers courtesy of Bilstein, and rides a full 20mm lower at the front and 15mm at the rear than a regular Corsa VXR – giving the car a low, controlled stance. The result? A seriously engaging track-taming sensation that does full justice to the VXR badge.



**Engine transmission and chassis improvements.** This new Clubsport model takes Corsa VXR performance to the limit. Running on a diet of 98 octane fuel, a revised turbocharger and Remus sports exhaust with reduced back pressure have helped push performance to a whole new level. The ABS traction control and electronic stability programme have all been recalibrated to accommodate the Clubsport's more potent set up. A Drexler multi-plate limited-slip differential helps tame the power during cornering or sudden changes in road surface while a high-performance Brembo braking system reins in the VXR Clubsport's blistering potential.

**VXR Clubsport features over Corsa VXR:**

- Unique 18-inch 10-spoke high-gloss black alloy wheels with 225/35 R 18 ultra-low profile tyres
- Black gloss grille bar
- Black gloss VXR mirror caps
- Unique extended front splitter
- Unique rear diffuser
- White stitching on seats, handbrake and gear lever gaiter
- Drexler mechanical multi-plate limited-slip differential
- Lowered Bilstein springs and inverted dampers (reduced by 20mm front, 15mm rear)
- Black Clubsport door sill covers
- Stainless steel Remus dual exhaust system with reduced back pressure
- Power: 205PS vs 192PS
- Torque: 250Nm vs 230Nm
- Torque with turbo overboost: 280Nm vs 260Nm

**Engine**

1.6i 16v ECOTEC-4 Turbo (1598cc)  
 Maximum power: 205PS\* (150kW)  
 @ 5750rpm

Maximum torque: 250Nm\*\*  
 (184 lb.ft.) @ 2250-5500rpm  
 Compression ratio: 8.8:1  
 Bore/stroke: 79.0mm x 81.5mm

- Modified engine management and turbocharger
- Intercooler
- Sodium-filled exhaust valves

\*Using 98-Ron unleaded fuel.  
 \*\*Increased to 280Nm with turbo overboost function.

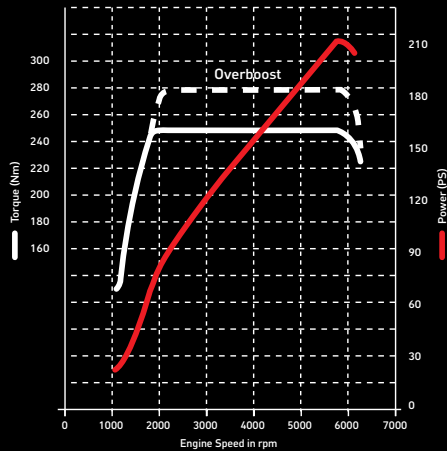

**Performance** (manufacturer's figures)

- Maximum speed: 143mph
- Acceleration 0-60mph: 6.5secs

**Transmission**

- Six-speed manual gearbox
- Gear ratios:
  - 1st - 3.82:1
  - 2nd - 2.16:1
  - 3rd - 1.48:1
  - 4th - 1.07:1
  - 5th - 0.88:1
  - 6th - 0.74:1
- Final drive - 4.18:1

**Fuel economy and emissions**

- mpg (litres/100km)
- Urban driving: 27.7 (10.2)
- Extra-urban driving: 46.3 (6.1)
- Combined figure: 37.2 (7.6)
- CO<sub>2</sub> emissions: 178g/km

**Suspension and brakes**

- Lowered Bilstein springs and inverted dampers
- Recalibrated ABS, traction control and ESP
- Upated and reduced weight Brembo front brakes
- Front ventilated disc brakes: 305mm diameter
- Rear disc brakes: 264mm diameter

**Insurance group** (ABI recommended)

- 34D



# ASTRA VXR

**When you're left breathless, sweating and with the sound of your own heartbeat pounding in your ears, don't say we didn't warn you.**

The Astra VXR certainly means business. Packing an aggressive 280PS, 400Nm 2.0 litre turbocharged direct injection engine, it's just begging to be taken out for a blast. With a custom-built chassis – developed at the renowned Nürburgring – featuring HiPerStrut front suspension with limited-slip differential and a Watts link semi-independent rear suspension there's unparalleled connection with the road. Add drop-dead exterior styling including meaty 19-inch alloys and this extraordinary VXR won't just turn heads – it'll blow minds.





# WHERE MAN MEETS MACHINE

Take a seat in Astra VXR and kick your senses into overdrive. From the very moment you get behind the wheel, you'll recognise this interior has been designed with real drivers in mind.

## Interior features

- Premium VXR sports front seats with Morrocana side bolsters
- Three-spoke flat-bottomed leather-covered sports steering wheel with VXR logo
- Unique VXR instrument graphics
- VXR floor mats
- VXR leather-covered gear knob
- VXR sports pedals
- VXR alloy-effect door sill covers

**1. VXR Instruments.** Bold instrument graphics and sports pedals set your heart racing before you've even turned the key. We've even included a flat-bottomed leather-covered steering wheel with VXR detail to give you something to cling to when the fun really starts.

**2. 3. VXR Infotainment.** A mobile phone system with Bluetooth® as standard and optional sat nav mean you can stay in touch wherever your journey takes you. A DMB digital radio and USB connection are there too to add that favourite soundtrack to your drive.





**VXR detailing.** The unique VXR detailing, premium VXR sports front seats and intuitive driver ergonomics leave no doubt as to why this VXR just demands to be driven.

**VXR Performance Seat Pack.** For the ultimate driving experience specify this optional Pack featuring powered lumbar and side bolster supports. This is also included when you choose the Leather Pack option (illustrated left and below). Available with black or blue central stripe.



# 3 LETTERS, 1 MESSAGE: VXR PERFORMANCE

Make no mistake about it – the Astra VXR was born to perform. Every inch of this adrenalin-pumping sporting masterpiece has been geared towards rubber hitting road. Don't believe us? Take a look for yourself:

## Exterior features

- VXR honeycomb sports front grille and air dam/bumper
- VXR side sills
- VXR rear bumper with diffuser **2**.
- VXR rear roof spoiler
- Performance-optimised twin-exit exhaust system tuned for sound
- LED rear lights
- 19-inch five-spoke alloy wheels

**VXR Aero Pack\***. Take VXR visual impact to the max.

- VXR bi-plane rear roof spoiler **1**.
- VXR extended side sills **4**.
- 20-inch five-Y-spoke bi-colour alloy wheels **4**.

**3. VXR button.** Hit the VXR button and the Astra VXR tightens the suspension, sharpens the throttle response and makes the steering more direct.

## VXR Performance Seat Pack\*.

The ultimate in comfort and support.

- Electrically adjustable sports front seats with manually adjustable seat cushions
- Electric lumbar and bolster adjustment
- Electrically heated front seats



\*Optional at extra cost.

**Engine, transmission and chassis.** The Astra VXR is not only one of the most powerful cars in its class, it's the fastest production Astra in Vauxhall's history. At its heart is a 2.0 litre turbocharged direct injection engine, producing 280PS of power and an impressive 400Nm of torque – capable of launching it to 60 miles per hour in 5.9 seconds.

### Engine

2.0i 16v ECOTEC-4 Turbo (1998cc)

Maximum power:

280PS (206kW) @ 5300rpm

Maximum torque:

400Nm (295 lb.ft.) @ 2400-4800rpm

Compression ratio: 9.3:1

Bore/stroke: 86.0mm x 86.0mm

- Turbocharger integrated into exhaust manifold

- Intercooler

- Sodium-filled exhaust valves

### Performance

(manufacturer's figures)

- Maximum speed: 155mph

- Acceleration 0-60mph: 5.9secs

### Fuel economy and emissions

mpg (litres/100km)

- Urban driving: 26.2 (10.8)

- Extra-urban driving: 43.5 (6.5)

- Combined figure: 34.9 (8.1)

- CO<sub>2</sub> emissions: 189g/km

### Chassis, suspension and brakes

- HiPerStrut front suspension system

**i** see page 31

- Lowered and uprated VXR sports suspension **i** see page 31

- Switchable Electronic Stability Programme (ESP) including traction control

- Brembo ventilated/cross drilled, front disc brakes: 355mm diameter

**i** see page 34

- Brembo 4-piston front brake calipers

**i** see page 34

- Ventilated rear disc brakes: 315mm diameter

- Drexler Limited Slip Differential (LSD)

**i** see page 33

### Transmission

- Six-speed manual gearbox

### Wheels and tyres

- 19-inch five-spoke alloy wheels with 245/40 R 19 ultra-low profile tyres

- 20-inch five-Y-spoke bi-colour alloy wheels with 245/35 R 20 ultra-low profile tyres (optional at extra cost as part of the VXR Aero Pack)

- Car supplied with emergency tyre inflation kit in lieu of spare wheel

### Insurance group (ABI recommended)

- 35E



Standard 19-inch five-spoke alloy wheels with 245/40 R 19 ultra-low profile tyres.



Optional at extra cost as part of the VXR Aero Pack, 20-inch five-Y-spoke bi-colour alloy wheels with 245/35 R 20 ultra-low profile tyres.

### Tyre rating (according to EU Regulation 1222/2009)

Tyre size	245/40 R 19	245/35 R 20
Fuel efficiency group	E	E
Wet grip performance	B	B
External noise measured (dB)	72	72
External noise group	<b>(C))</b>	<b>(C))</b>

# NEW INSIGNIA VXR SUPERSPORT

**If New Insignia speaks a whole new language. New Insignia VXR SuperSport talks in absolutes.**

New subtle yet aggressive styling and design cues perfectly complement the awesome 2.8 litre V6 Turbo that develops 325PS. A massive 435Nm of torque. 0-60mph acceleration in just 5.6 seconds\*. And with an unrestricted top speed, the new SuperSport now realises this VXR's true performance potential\*\*. But it's not just about absolute power. But absolute control. An adaptive 4X4 system, electronic Limited Slip Differential (eLSD) and HiPerStrut front suspension system put the driver in total command. And you can specify an automatic model with paddle-shift controls on the steering wheel. Because we understand that with power, comes responsibility.

\*Manual hatchback and saloon models.

\*\*Where permitted. General Motors UK Ltd. does not condone irresponsible driving.





VXR

# NEW INSIGNIA VXR SUPERSPORT

Familiar yet unmistakably unique, the New Insignia VXR SuperSport's new exterior styling says more about this car's performance than words ever could.

Instantly memorable, the new front and rear styling give the VXR SuperSport instant road presence. The muscular front bumper with vertical air intakes, rear diffuser and integrated matt chrome tailpipes feature on all three models, hatchback, saloon and Sports Tourer. But this new VXR model says everything about performance styling in the appropriate tone. When you're this confident in your ability, there's no need to raise your voice.

20-inch alloy wheels and two-coat metallic paint optional at extra cost.





# DYNAMIC PERFORMANCE NEEDS DYNAMIC STYLE

Strapping yourself into the driver's seat of the New Insignia VXR SuperSport has never been so enjoyable. Awe-inspiring on every level, the high levels of comfort and technology are there for all to see. Standard across the VXR SuperSport range, Navi 900 IntelliLink infotainment unit features a wealth of modern technologies, including our new touch-pad designed specifically to bond driver with machine.

**1. Sporting comfort.** Sit back, buckle up and wait for the fun to start. Recaro front seats add a sense of comfort and style to an already impressive interior. The driver's seat has lumbar adjustment and Morrocana-trimmed side bolsters for ultimate comfort.

**2. 3. Ultimate connectivity.** The Navi 900 IntelliLink unit complete with satellite navigation brings your digital life into your car. You can use IntelliLink to connect to your smartphone or tablet device, select music and make calls all at the touch of a screen or swipe of our first ever touch-pad.

**4. VXR instruments.** New Insignia VXR SuperSport takes care of the driver information via a high quality 8-inch colour digital display with G-Force meter. Additional red accented instruments add to the VXR's impressive line-up of modern technologies.

**5. Sporting details.** The VXR's sporting pedigree is clearly evident thanks to the VXR gear knob, VXR logo floor mats and alloy-effect door still covers.

**Automatic transmission with paddle-shift.** New Insignia VXR SuperSport is also available with a six-speed automatic transmission complete with steering wheel mounted paddle-shift for fingertip sequential gear changes.



## Interior features

- Recaro sports front seats with Morrocana-trimmed side bolsters
- Driver's and front passenger's front, side-impact and curtain airbags
- Three-spoke flat-bottomed leather-covered sports steering wheel with VXR logo
- 8-inch digital instrument display
- VXR floor mats
- VXR sports pedals
- VXR leather-covered gear knob
- VXR alloy-effect door sill covers
- Navi 900 IntelliLink satellite navigation system with 8-inch colour touch-screen
- Digital radio
- Stereo radio/CD/MP3 CD player
- Aux-in, SD card and USB sockets
- Audio streaming
- Bluetooth® connectivity
- Multi-function touch-pad infotainment controller
- Ambient interior lighting
- Automatic lighting control
- Electro-chromatic anti-dazzle rear-view mirror
- Single-zone electronic climate control
- Cruise control
- Trip computer
- Remote control security alarm system

Dual-zone electronic climate control, front and rear parking distance sensors and VXR Leather Pack are optional at extra cost.



# PERFORMANCE TO THRILL PRESENCE TO INSPIRE

The VXR styling features are a clue to a truly unique machine. Beneath this exterior is an exceptional performance engine. A 2.8i, 24-valve, V6 turbocharged engine that propels this four-wheel drive car at an astonishing rate. Pure performance meets pure style.

## Exterior features

- VXR front grille and air dam/bumper 1.
- VXR side sills
- VXR rear bumper and rear skirt
- VXR rear lip spoiler (hatchback/saloon)
- VXR rear roof spoiler (Sports Tourer)
- Performance-optimised exhaust system tuned for sound 5.
- Intelligent Adaptive Forward Lighting (AFL) incorporating bi-xenon headlights
- Rain-sensitive windscreen wipers
- Tyre pressure monitoring system

**2. Brembo Brakes.** Four-piston Brembo front brakes add to the VXR's impeccable sporting credentials. The cast iron discs mounted on an aluminium centre reduce weight improving the VXR's braking and overall performance.

**3. Alloy wheels.** Serious wheel and tyre combinations are a VXR speciality. New Insignia VXR SuperSport comes with 19-inch V-spoke alloys and high-grip 245/40 R 19 ultra-low profile tyres as standard. Want to go bigger? Try the 20-inch alloy option with 255/35 R 20 ultra-low profile tyres.

**4. VXR button.** Hit the VXR button and the New Insignia VXR SuperSport tightens the suspension, sharpens the throttle response and makes the steering more direct.



**Engine, transmission and chassis.** Make no mistake, New Insignia VXR SuperSport was designed to perform. All three models hatch, saloon, and Sports Tourer benefit from new front and rear styling, with signature VXR design elements. But it's not just the appearance that has been improved. The adaptive all-wheel-drive chassis has been revised as has the ESP software and NVH (Noise Vibration Harshness) – for an all round improved driving experience. The end result? Seamless, explosive power delivery. Through computer-controlled, Nürburgring-proven, 4X4 chassis that puts you in total control.

## Engine

2.8i 24v ECOTEC-V6 Turbo (2792cc)

Maximum power:  
325PS (239kW) @ 5250rpm

Maximum torque:  
435Nm (321 lb.ft.) @ 5250rpm

Compression ratio: 9.5:1

Bore/stroke: 89.0mm x 74.8mm

- Single, twin-scroll turbocharger with intercooler

- Variable valve timing

## Performance (manufacturer's figures)

Maximum speed (mph):

	Man	Auto
Hatch/Saloon	168	165
Sports Tourer	165	162

Acceleration 0-60mph (secs):

Hatch/Saloon	5.6	5.9
Sports Tourer	5.9	6.2

## Fuel economy and emissions

mpg (litres/100km)

	Man	Auto
Urban driving:		
Hatch/Saloon	17.9 (15.8)	17.9 (15.8)
Sports Tourer	17.7 (16.0)	17.2 (16.4)

Extra-urban driving:

Hatch/Saloon	37.2 (7.6)	36.2 (7.8)
Sports Tourer	35.8 (7.9)	35.8 (7.9)

Combined figure:

Hatch/Saloon	26.6 (10.6)	26.4 (10.7)
Sports Tourer	25.9 (10.9)	25.7 (11.0)

CO<sub>2</sub> emissions: g/km:

Hatch/Saloon	249	251
Sports Tourer	255	259

## Chassis, suspension and brakes

- HiPerStrut front suspension system

 see page 31

- Adaptive 4X4 permanent four-wheel drive system with FlexRide

 see page 33

- Brembo ventilated/cross drilled, front disc brakes: 355mm diameter

 see page 34

- Brembo 4-piston front brake calipers  see page 34

- Ventilated rear disc brakes: 315mm diameter

- Electronic Limited Slip Differential (eLSD)  see page 33

## Transmission

- Six-speed manual gearbox

- Six-speed automatic with paddle-shift facility optional at extra cost

## Wheels and tyres

- 19-inch V-spoke alloy wheels with 245/40 R 19 ultra-low profile tyres



- 20-inch five Y-spoke bi-colour alloy wheels with 255/35 R 20 ultra-low profile tyres, optional at extra cost (illustrated on page 25)

- Emergency tyre inflation kit in lieu of spare wheel

## Insurance group (ABI recommended)

- 36E

## Tyre rating (according to EU Regulation 1222/2009)

Tyre size	245/40 R 19	255/35 R 20
Fuel efficiency group	E	E
Wet grip performance	B	B
External noise measured (dB)	72	73
External noise group		

# TECHNOLOGY EXPLAINED

You don't have to be a race car designer to understand why VXR models are so special. The results speak for themselves. But just in case you're wondering about what lies behind our performance features, we've explained a few of them here in a little more detail.

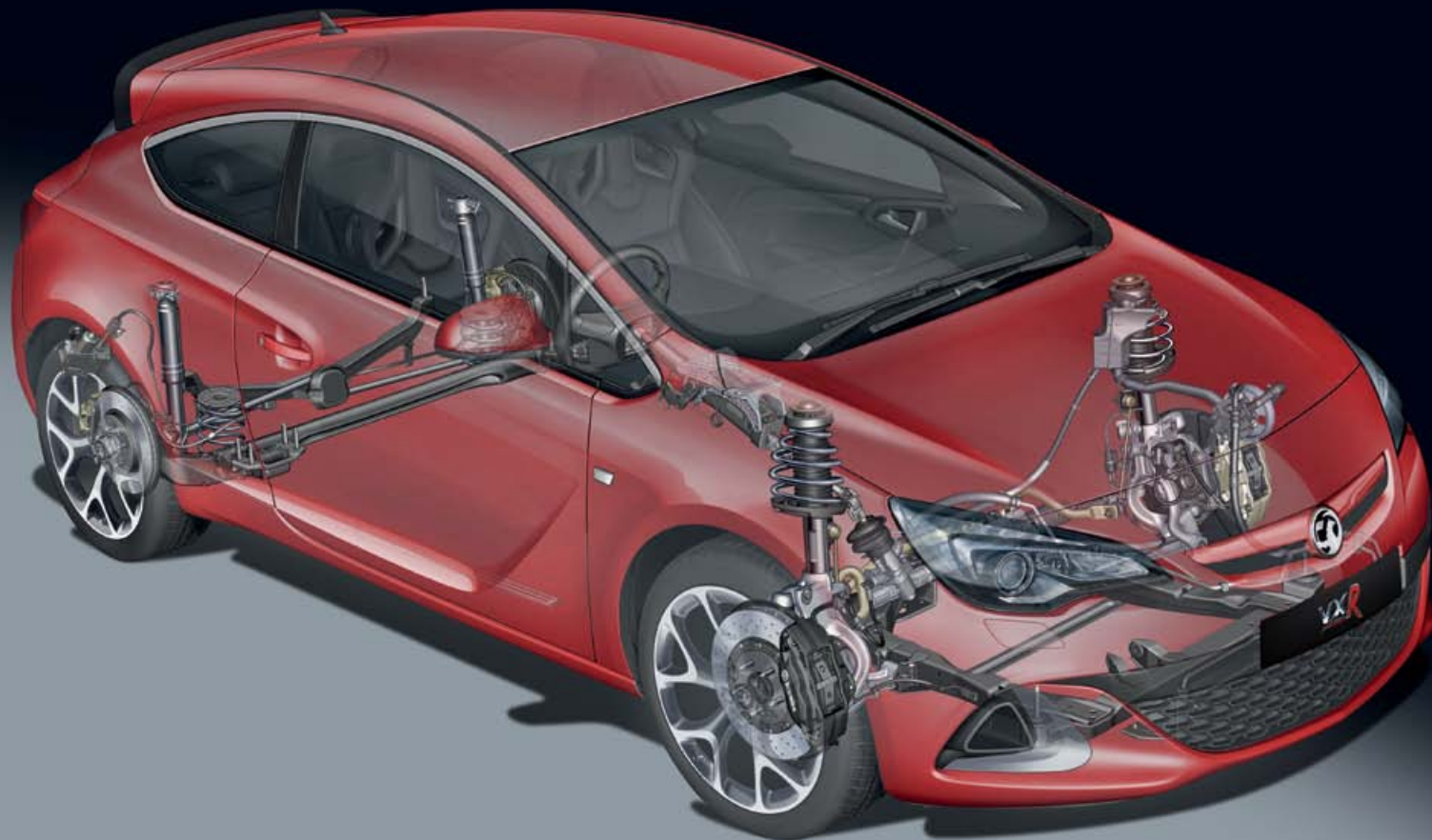

**1. Sports suspension.** It could be argued that creating a sports suspension system is relatively easy; simply fit some uprated springs, dampers and, possibly, anti-roll bars and it's ready. There are plenty of aftermarket kits available, after all. But for VXR we wanted to go a few steps beyond.

VXR models feature all of these, naturally, but we've incorporated a number of extra suspension and steering revisions that separate them from other sports models in the Vauxhall range. Features such as stronger, low-friction anti-roll bar mounts and drop links, which allow the anti-roll bars to work at peak efficiency at all times. Rebound stop springs within the dampers, designed to reduce traction-robbing pitch from the chassis, and revised steering geometry, which gives drivers increased feedback and allows them to more accurately judge grip levels. In fact, the Corsa VXR Clubsport model features specially commissioned progressive-rate springs and inverted monotube dampers courtesy of Bilstein. In addition to the considerable chassis work on the UK's unique road surfaces, much of the development of the VXR range was carried out at the legendary Nürburgring Nordschleife circuit in Germany, the ultimate test of chassis performance. Manuel Reuter, twice winner of the Le Mans 24-hour race, was on the test team and his vast experience contributed to the final set-up of the cars.

**2. HiPerStrut front suspension.** The Astra VXR and New Insignia VXR SuperSport use a significant evolution of the regular models' MacPherson strut front suspension. The HiPerStrut (High Performance Strut) front suspension improves grip and allows more power to be applied during cornering. The realigned kingpin axis keeps the front tyres squarer to the road during cornering, providing a better contact patch with the tyre thus delaying the onset of understeer. Additionally the shorter spindle length on the hub significantly reduces torque steer and resists steering kickback on bends and on uneven surfaces. The New Insignia VXR SuperSport has also undergone extensive chassis improvements for even more precise handling and understeer control. In addition, compared to the standard Astra GTC and Insignia SRi models, the ride height of the Astra VXR and New Insignia VXR SuperSport has been reduced by 10mm, spring rates have been stiffened and bespoke suspension bushes are used. To achieve the best handling balance, the front and rear anti-roll bar diameters have also been revised. All of this bespoke VXR engineering detail allows the driver to better exploit the power potential of both these powerful VXR models.

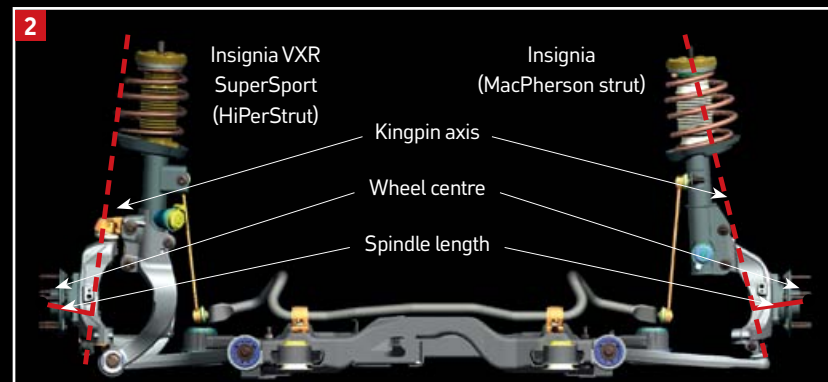

# TECHNOLOGY EXPLAINED



1

**1. New Insignia VXR SuperSport Adaptive 4X4.** The advantages begin when you pull away. All four wheels of the Insignia are engaged for stable acceleration with maximum grip. In normal driving, the power is split 95% front/5% rear, but under acceleration the system automatically diverts more power to the rear wheels for maximum traction before gradually moving power back towards the front wheels. With either the VXR or Sport button depressed, the system apportions more power to the rear wheels in a 40% front/60% rear split to give an even more sporting feel.

**New Insignia VXR SuperSport Electronic Limited Slip Differential (eLSD).** The electronic Limited Slip Differential (eLSD) is fitted as standard to the rear of the New Insignia VXR SuperSport offering even more benefits for the enthusiastic driver. By sensing which rear wheel has the most grip, eLSD can transfer more torque to the wheel most able to utilise it. Up to 50% of the rear axle torque can be transferred between the rear wheels, increasing stability during high speed lane changes and providing more traction when accelerating out of corners.

**2. FlexRide (Adaptive Stability Technology).** The Astra VXR and New Insignia VXR SuperSport models feature FlexRide – providing three different driving modes: 'VXR' for ultimate driving dynamics (tighter suspension, sharper throttle response and more direct steering) or 'Sport' for everyday sporty driving. 'Normal' is the default mode. The FlexRide adaptive chassis control system with Continuous Damper Control (CDC) monitors the roll, pitch and yaw of the car, and changes the rate of damping on each wheel to optimise the handling and selectively stiffens the suspension. This means the vehicle will exhibit a reduced rate of roll and pitch, making it more responsive during direction changes and more settled during the braking/turn-in/acceleration transition when cornering. The



FlexRide dampers contain magneto rheological (MR) fluid – magnetic particles suspended in a synthetic fluid which change flow rate when a magnetic field is applied. Complex algorithms within the CDC system use acceleration, braking and cornering data to instantaneously adjust the electrical current applied to the electromagnetic coil within each damper – the higher the charge, the greater the damping resistance.

**Limited Slip Differential (LSD).** Limited Slip Differential (LSD). The Corsa VXR Clubsport and Astra VXR respectively are the most powerful production Corsa and Astra models ever produced. And to assist putting their power onto the road, both these models have been equipped with a motorsport-derived Drexler Limited Slip Differential. Following extensive development the usual aggressive intervention from a front-wheel drive LSD has been re-tuned to provide outstanding traction and stability without affecting driver enjoyment.

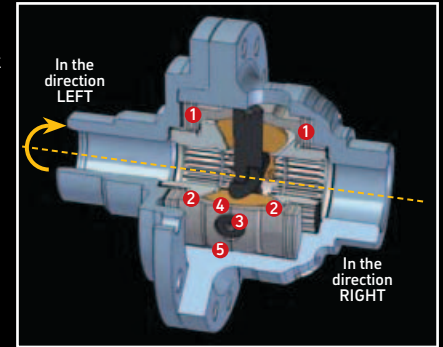

These VXR's Drexler LSD uses a series of clutch plates ① that restricts significant differences in rotational speed between the front wheels limiting wheelspin and enhancing stability. Acceleration and deceleration cause pressure rings ② next to the clutch plates to push sideways and compress the clutch stack – reducing the speed variation between the two driven wheels. Shaped cams on the differential axis ③ – reacting to differences in torque in the differential vary the amount of compression in the clutch stack – changing the amount of rotational difference between each wheel.

The speed of reaction and the amount of rotational difference are determined by the 'ramp angles' ④ ⑤ in the pressure rings. The lower the ramp angle, the higher the pressure applied to the clutch stack. On VXR the ramp angles are set-up to provide different characteristics under acceleration and deceleration.

# TECHNOLOGY EXPLAINED

**1. Brembo braking systems.** Corsa VXR Clubsport, Astra VXR and New Insignia VXR SuperSport's all feature a four-piston Brembo front braking system featuring larger diameter ventilated and on Astra VXR and New Insignia VXR SuperSport, cross-drilled front discs. The cast iron discs are mounted on an aluminium centre reducing weight and improving performance. Combined with lighter caliper the new Brembo brakes are up to 30% lighter than the standard system. In each instance the new set-up also utilises high-performance pads which are also 10% larger – giving exceptional stopping power.

**2. Reduced unsprung weight.** Every aspect of a VXR has been considered when it comes to performance. On Astra and Insignia the HiPerStrut front suspension, 20-inch bi-colour alloy wheels with Pirelli P Zero tyres and lightweight Brembo front brakes all combine to reduce unsprung weight by up to 7.5kg per front corner (Astra). This ensures better handling as the car can react more quickly to changes in the road surface improving grip and ride. Lighter wheels/tyres/brakes also require the engine to move less rotational mass – thus improving performance and economy.



**3. Astra VXR Performance Seat Pack.** The Astra VXR's lightweight performance front seats use composite technology to provide the optimum driver position, lateral location during cornering and ergonomic comfort. The injection moulded shells are formed from a composite of polyamide and fibreglass providing excellent strength and rigidity. Additional benefits include reduced weight (45 percent lighter) and reduced seat depth.

Both driver and front passenger seats are 40mm lower than the Astra Hatchback – helping reduce the VXR's centre of gravity. Despite their overt sporting characteristics the seats can be adjusted up to 18 ways, depending upon specification. Optional pneumatically adjustable side bolsters, provide the optimum lateral location, when ordered as part of the VXR Leather Seat or VXR Performance Seat Pack.



Left-hand drive seat illustrated.

# INFOTAINMENT

There isn't much you can add to improve a VXR, but a range of extra-cost options is available just in case you want to personalise it a little further to suit your own needs. We've only included a sample of what's available here. The VXR Price Guide has all the details.

**Satellite navigation.** Available for Astra VXR. Find your way to anywhere, at any time. Satellite navigation can determine your location and guide you to your destination by the best and fastest route. The Traffic Message Channel function can even change the route according to breaking traffic news.

**1. New Insignia VXR SuperSport models feature the Navi 900 IntelliLink system as standard.** This state-of-the-art touch-screen system includes 3D map visualisation and one-shot voice commands for navigation, phone calls and audio track choice. The system also features an intelligent touch-pad with handwriting recognition facility providing unparalleled functionality.

**2. Bluetooth® connectivity.** Standard on Astra VXR and New Insignia VXR Supersport, optional on both Corsa VXR models, the system enables your mobile phone to interface with the infotainment unit for operation via the steering wheel control, fascia display or voice activation via Bluetooth®.

**3. Astra VXR and New Insignia VXR SuperSport can be specified with an optional premium sound system.** Includes amplifier and speaker upgrades together with digital sound processing for superb all-round sound reproduction under all driving conditions.



4



**4. Corsa Touch and Connect.** An intuitive touch-screen navigation system complete with USB connection and Bluetooth® connectivity featuring 4x20W per channel output and seven premium speakers.

# NEW VXR8 GTS

**If you want to make a stand, then it's time to take a seat.**

With its aggressive new look and awe-inspiring performance DNA to match, the Vauxhall VXR8 GTS redefines world-class saloon design with more presence, more power and more passion than ever before. So, if you're not yet ready to let life pass you by, strap yourself in, take the wheel and enjoy the ultimate driving experience.





# NEW VXR8 GTS

**Often heard before seen, this is quite simply the most powerful VXR to date.**

Beneath the stunning lines of the new VXR8 lurks a supercharged 6.2 litre V8 motor that delivers a jaw-dropping power statistic of 585PS and 740Nm of torque and rockets it to 60mph in under 4.5 seconds. New safety features like monstrous forged aluminium brake discs that peer from behind giant alloy wheels and torque vectoring together with independent rear suspension controlled by the best in electronic active safety chassis control help tame this four-door beast of a muscle car from Vauxhall.





# THE SEAT OF POWER

Step inside the new VXR8 and the first thing you'll notice is that everything has been created to put the driver first. The performance front seats, the head-up display, sports instrument panel, driver preference dial and the flat-bottomed steering wheel all confirm this is a true drivers car. In other words, a VXR.

**1. Performance facia.** The VXR8 GTS steering wheel means business – leather-covered and flat-bottomed with perforated grip zones and remote audio controls. The steering column is reach and rake adjustable too. Other features include a state-of-the-art infotainment system featuring CD player with USB connection and aux-in, integrated iPod support and Bluetooth® connectivity.

**2. Driver Preference Dial.** The VXR8 GTS allows you to choose your ideal ride. Choose from touring, sport, performance and track and the vehicle's ESC, traction control, launch control (manual transmission only), and bi-modal exhaust, as well as its brake torque vectoring and new electronic power steering, will adjust accordingly.

**3. Keyless entry and start.** The keyless system with key fob recognition and vehicle locking provides added security. This system increases convenience in day-to-day operation and improves protection against theft.

**4. Sports Instrumentation.** The VXR8 GTS sports instrumentation also features auxiliary gauges that display oil temperature, boost pressure and battery voltage. In addition, the head-up display shows a range of useful driver information on the windscreen, such as vehicle speed and the new G-forces meter.

**5. Performance seats.** VXR8 GTS's performance front seats have eight-way electrical adjustment with lumbar support adjustment. Trimmed in Onyx leather, they also feature ergonomically enhanced side bolsters contoured for greater comfort and lateral support.



### Interior features

- Dual-zone electronic climate control
- VXR Performance seats in Onyx Leather Trim
- Eight-way electric adjustment of driver and front passenger seat
- Heated front seats
- Leather-covered flat bottomed sports steering wheel
- Steering wheel mounted controls for audio system, trip computer, Bluetooth® and EDI
- Auxiliary gauges displaying oil temperature, oil pressure and boost pressure
- Centre console VXR8 I.D. plate
- Leather-covered gear lever
- Sports pedals
- Premium BOSE® audio with nine speakers
- Enhanced Driver Interface  
■ see page 48
- Mobile phone system with Bluetooth® (does not include phone)

The VXR8 features an 8-inch high-resolution, colour touch-screen display along with USB input, Single CD player with the capability to play MP3 tracks, full iPod integration and a nine-speaker BOSE® premium audio system.

### Exterior dimensions mm (inches)

- Length 4988 (196.3)
- Height 1457 (57.3)
- Width including mirrors 1899 (74.7)

### Insurance group (ABI recommended)

- 50U



# MEET THE WOLF IN WOLF'S CLOTHING

If you've never driven a V8 muscle car before, then prepare to get noticed as the New VXR8 GTS just demands attention. From the muscular stance to the guttural roar of the V8 engine, this super-car takes centre stage wherever it goes and simply demands to be driven. A supercharged 6.2 litre engine that delivers an astonishing 585PS of power with a chassis to handle it means this is a machine truly worthy of its VXR badge.

## Exterior features

- Sports high performance front styling **1**.
- Projector headlights for greater high beam range plus LED daytime running lights **1**.
- 20-inch Blade forged alloy wheels – satin graphite **2**.
- Sports LED rear lights **3**.
- Superflow performance rear spoiler **3**.
- Rear bumper incorporating lo-line sports rear spoiler and quad exhaust outlets with shadow chrome tips **4**.

**Racing style.** The aggressive new styling on the New VXR8 GTS looks fearsome at every angle. One glance in their rear view mirror will leave other drivers feeling immediately inferior. From the roadside, the performance alloy wheels – 20x8.5-inch at the front and 20x9.5-inch at the rear fitted with Continental ContiSport Contact 5P tyres will look menacing to say the least.



**Engine, transmission and chassis.** The LSA 6.2 litre engine is not your ordinary V8. Read the data. An almighty 585PS @ 6150rpm. 740Nm of torque @ 3850rpm. Solid-state direct fire ignition, with a high energy coil for every single cylinder. Hi-flow exhaust system with x-pipe intermediate and bi-modal silencers. And a grin from ear to ear every time you fire it up. To say nothing of the rush of adrenalin from a chassis that now features launch control and performance suspension with third generation magnetic ride control and brake torque vectoring technology.

## Engine

6.2 LSA Supercharged V8 petrol (6162cc)

Maximum power:  
585PS @ 6150rpm

Maximum torque:  
740Nm @ 3850rpm

Bore/stroke: 103.9mm x 92.0mm

- Aluminium alloy cylinder block and high-flow cylinder heads
- Electronically-controlled bi-modal air intake
- Cast steel roller rocker arms, roller cam followers
- Cross-bolted five main bearings with six bolts per bearing cap
- Hi-flow exhaust system with x-pipe intermediate and bi-modal silencers

## Performance (manufacturer's figures)

Maximum speed (mph):

Man	Auto
155	155

Acceleration 0-60mph (secs):

4.2	4.2
-----	-----

Acceleration 50-70mph (secs):  
(3rd gear)

2.1	N/A
-----	-----

## Fuel economy and emissions

	Man	Auto
Urban driving:	12.9 (21.9)	12.7 (22.3)
Extra-urban driving:	24.4 (11.6)	23.9 (11.8)
Combined figure:	18.5 (15.3)	18.0 (15.7)
CO <sub>2</sub> emissions: g/km	363	373

## Chassis, suspension and brakes

- Variable-ratio power-assisted rack and pinion steering
- Performance suspension with Generation 3 MRC **i** see page 51
- MacPherson strut direct acting stabiliser bar. Progressive-rate coils springs
- Fully independent multi-link rear suspension with progressive-rate springs
- Electronic Stability Programme incorporating, ABS, ESC, EBA, TCS and Torque Vectoring
- Competition mode ESC
- Launch control (manual models only) **i** see page 50
- Front ventilated disc brakes: 390mm diameter, featuring forged 6-piston calipers with two-piece, cross-drilled front and rear rotors
- Rear ventilated disc brakes: 372mm diameter, featuring forged 4-piston calipers with two-piece, cross-drilled front and rear rotors
- Red front and rear aluminium brake calipers

## Transmission

- Limited-slip differential
- Six-speed manual gearbox
- Gear ratios (manual):  
1st – 2.66:1, 2nd – 1.78:1, 3rd – 1.30:1, 4th – 1.00:1, 5th – 0.80:1, 6th – 0.63:1, Final drive – 3.73:1
- Six-speed automatic transmission optional at extra cost
- Gear ratios (auto):  
1st – 4.03:1, 2nd – 2.36:1, 3rd – 1.53:1, 4th – 1.15:1, 5th – 0.85:1, 6th – 0.67:1, Final drive – 3.23:1

## Wheels and tyres

- 20-inch forged alloy wheels
- ContiSportContact 5P tyres
- 255/35 R 20 ultra-low profile front tyres
- 275/35 R 20 ultra-low profile rear tyres
- Tyre pressure monitoring system
- Optional spare wheel



## Tyre rating (according to EU Regulation 1222/2009)

Tyre size	255/35 R 20	275/35 R 20
Fuel efficiency group	F	E
Wet grip performance	A	A
External noise measured (dB)	73	73
External noise group	<b>(b)</b>	<b>(b)</b>

# NEW VXR CLUBSPORT R8 AND MALOO R8

The VXR8 GTS has the ability to instinctively engage every facet of the vehicle's performance so you feel, not just think the driving experience. The VXR8 Clubsport R8 Saloon and Tourer models and the awesome VXR8 Maloo R8 embody that same philosophy.

**Dynamic range.** All three models are available to special order only and built to your specification. Both VXR8 Clubsport R8 Saloon and Tourer models make a bold statement about who you are and your passion for driving. The VXR Maloo R8 is a sport utility pick-up that is the ultimate expression of work hard play hard. With a unique 'sailplane' design falling directly behind the cockpit the aerodynamic VXR Maloo R8 is one good looking and powerful workhorse.



**The bold design of the Maloo R8 is power in itself.** The sculpted theme of the new bonnet flows through to the performance sailplane and remote locking hard tonneau.



**The Clubsport R8 means business and looks like it.**

The sculpting of the new bonnet and boot together with the lo-line body-colour spoiler deliver a dynamic, sporty look.



**As with the Clubsport R8, there's no compromise on style, performance and comfort.** But the Clubsport R8 Tourer comes with even more flexibility and cargo carrying capacity. The looks speak for themselves.



# NEW VXR8 GTS ENHANCED DRIVER INTERFACE

Enhanced Driver Interface (EDI) is the centrepiece of the New VXR8 GTS. Never before has the driving enthusiast been able to engage with their vehicle on this level. EDI connects with the onboard computer to constantly stream real-time vehicle dynamics and performance data to the touch-screen display.

With the touch of your finger EDI will allow you to display real-time performance data such as vehicle G-Forces, power and torque, and lap-times. If this is not enough, the real enthusiast can even download their track day data and analyse their performance using the MoTec i2 software provided. Driver information such as the performance of the chassis dynamics systems can also be displayed as well as live information about the operation of the bi-modal exhaust.



**Main menu.** Navigate your way through EDI using the touch-screen or the EDI button on the steering wheel.

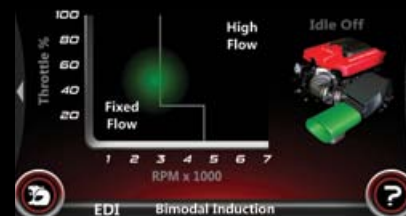

**Bi-modal exhaust.** Displays important information of the performance of the bi-modal induction system.



**Driver.** Driver screen keeps you close to key inputs such as RPM, accelerator and brake pedal positions, and gear position.

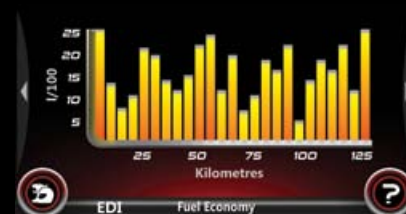

**Fuel Economy.** This screen displays the fuel economy history.



**Gauges.** Select your gauges for real-time information such as Power, Torque, Manifold Pressure, Fuel, Elevation, or Air Temp. (intake or external).



**Stopwatch.** Perfect for hill climbs, road rallies and your competitive instincts.



**Data Logging.** Download your recorded information onto a USB stick and review it later on your PC.



**Dynamics.** Understand your vehicle's behaviour with an understeer and oversteer display.



**G-Force.** Feeds live information on longitudinal and lateral G-Forces.

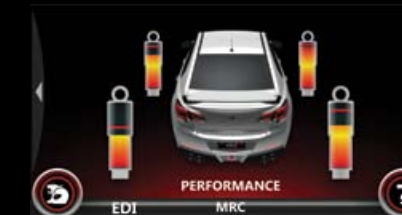

**MRC performance data.** Monitor the performance of the magnetic ride control system in real time.

# NEW VXR8 GTS CHASSIS DYNAMICS

For a passionate driver, nothing beats a car that is as unique as its driver. The VXR8 GTS comes with many exciting extras. Launch Control allows you to accelerate from a standstill at its maximum potential and a Magnetic Ride Control (MRC) suspension system takes muscle car tuning to a whole new level enabling a dynamic blend of ride and handling that has never before been felt on a VXR. Driver safety systems have also been enhanced with the introduction of forward collision alert and lane departure warning.

**Side blind zone alert system.** The system monitors the surrounding traffic to keep the driver informed during lane changing situations. Multiple sensors around the car emit ultrasonic waves across key lane transition zones to keep you aware of any adjacent cars travelling in the same direction that may not always be visible in your mirrors.

**Forward collision alert.** A camera, located above the rear view mirror, scans the road ahead up to 14 times per second. When a collision is predicted, the driver is alerted with an audible tone and a visible alert in the head-up display. Anticipating hard braking, the system applied sufficient brake pressure to close the space between the brake pads and rotors, thus delivering a quicker brake response time.

**Lane Departure Warning.** Helps to combat the results of distraction and drowsiness on the road. It alerts the driver to any unintentional lane departures with a warning indicator and an audible sound.

**Brakes.** With monstrous front and rear brakes and wider rear tyres, the VXR8 GTS continues to deliver our best ever braking package. Increased brake rotor diameters have enabled improvements in brake modulation and feel while the new 'radical' low weight caliper design has allowed a larger, high performance caliper without sacrificing unsprung mass. The VXR8 GTS brake calipers are finished in red embossed with a silver VXR logo.

**Launch Control (manual vehicles).** This system enables the vehicle to accelerate from standstill at its maximum potential. Launch control differs from traction control in that traction control focuses on vehicle stability (particularly in an emergency situation) whereas launch control focuses on providing control of the driven wheels to maximise acceleration during the initial set-off.

**Competition Mode Electronic stability Control (ESC).** Specifically designed to provide the driver with more steering input and control under specific conditions. The revised ESC calibration allows more aggressive cornering; permitting more oversteer and understeer, before an intervention occurs. A more progressive ESC intervention ensures you get the most out of your car. When used correctly, Competition Mode will allow you to improve your lap times over the standard ESC setting.

**Torque vectoring.** Helps reduce understeer by generating a 'rotational moment' in the rear axle when the vehicle is under power. The vehicle's Electronic Stability Control system detects the understeer event, applies braking to the inside rear wheel and transfers torque to the outside rear wheel.

**Generation 3 MRC.** Fitted as standard to the VXR8 GTS, MRC is a suspension system that integrates dynamic hardware with advanced software. With electronic control over suspension damping, the VXR8 GTS takes V8 muscle car suspension tuning to a new and exciting level. No longer confined to the limitations of conventional dampers (velocity sensitive damping), MRC is an intelligent control system that is able to take information from multiple inputs and calculate the desired level of damping in the blink of an eye.

The new Generation 3 MRC system uses a two coil tapered slot piston design for front and rear dampers. This means that two coils are used per damper instead of one, making the Generation 3 system twice as fast as the Generation two system. The result is a blend of ride and handling that has never before been felt on a VXR model. The MRC system features switchable ride control which enables 'Performance' and 'Track' modes.

The finely tuned 'Performance' mode offers a sharper response with reduced body roll. For the ultimate driving sensation 'Track' mode, combined with 20" wheels, rides like a race tuned Supercar. MRC is a semi-active suspension technology with no electro-mechanical valves and no small moving parts, which provides for durability and reliability.

As a result the VXR8 GTS driver not only benefits from increased performance, but safety, comfort and balance for positive stopping power. At the heart of MRC is a central controlling unit that updates each damper every 1000th of a second to the slightest change in road condition or driving style. The MRC-based semi-active suspension system consists of magneto rheological fluid-based monotube struts, monotube shock absorbers, a position sensor set and an onboard controller.

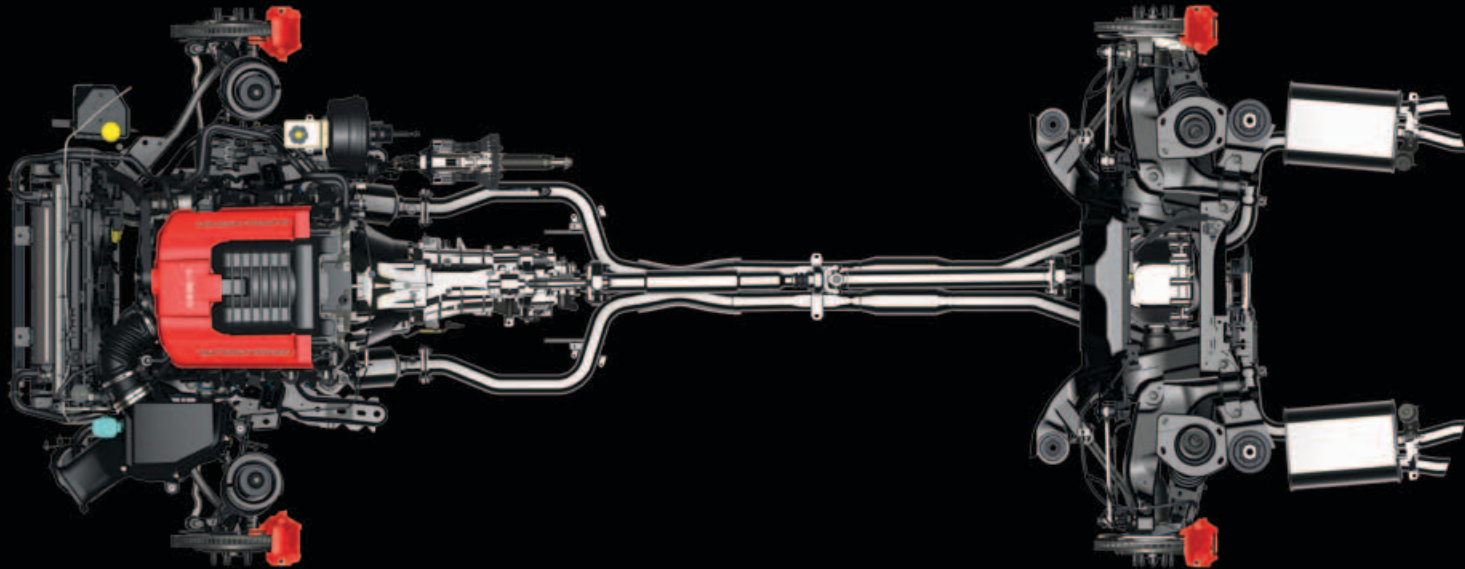

# COLOURS AND OPTIONAL TRIMS

VXR models are available in a range of great exterior colours, with complementary interior trim materials – fabric or leather – specially selected to reflect the range's performance heritage.

## Corsa VXR



Glacier White – Brilliant\*



Flame Red – Solid



Silver Lake – Two-coat metallic\*



Carbon Flash – Two-coat metallic\*



Arden Blue – Two-coat pearlescent\*

## Corsa VXR Clubsport



Glacier White – Brilliant\*



Carbon Flash – Two-coat metallic\*



Asteroid Grey – Two-coat pearlescent\*

## Astra VXR



Power Red – Solid (two coat)



Summit White – Brilliant\*



Carbon Flash – Two-coat metallic\*



Arden Blue – Two-coat pearlescent\*

\*Optional at extra cost.

Due to the limitations of the printing process the colours reproduced may vary slightly from the actual paint colour and trim material. As a result they should be used as a guide only.



**Corsa VXR.** Standard: Charcoal Splice cloth with Morrocana-trimmed seat bolsters (illustrated on page 8).  
Optional at extra cost: Leather Pack (illustrated above) comprising leather seat facings and heated front seats.

**Corsa VXR Clubsport.**

Charcoal Splice cloth/Morrocana (illustrated on page 12).



**Astra VXR.** Standard: Jet Black Track cloth seat inserts with Cool Pearl stitching on Morrocana-trimmed seat bolsters (illustrated above).

Optional at extra cost: Jet Black Nappa soft leather seat inserts with Jet Black stripe and Cool Pearl stitching on seat bolsters (illustrated on page 19).

Jet Black Nappa soft leather seat inserts with Blue stripe and Blue stitching on seat bolsters (illustrated on page 19).

# COLOURS AND OPTIONAL TRIMS

The New Insignia VXR SuperSport and New VXR8 GTS are available in a range of striking exterior colours – specially selected to reflect their performance pedigree.

## New Insignia VXR SuperSport



Power Red – Solid (two-coat)



Summit White – Brilliant\*



Carbon Flash – Two-coat metallic\*



Silver Lake – Two-coat metallic\*



Asteroid Grey – Two-coat pearlescent\*



Arden Blue – Two-coat pearlescent\*

## New VXR8 GTS



Heron White – Solid



Nitrate Silver – Two-coat metallic



Perfect Blue – Two-coat metallic



Regal Peacock – Two-coat metallic



Sting Red – Solid



Phantom Black – Two-coat metallic



Karma – Two-coat metallic



Alchemy – Two-coat metallic††



Fantale Orange – Solid†



Prussian Steel – Two-coat metallic

\*Optional at extra cost.

†Not available on Clubsport R8 Tourer models.

††Not available on Maloo R8 models.

Due to the limitations of the printing process the colours reproduced may vary slightly from the actual paint colour and trim material. As a result they should be used as a guide only.



**New Insignia VXR SuperSport.** Standard: Track cloth/Morrocana (illustrated above left).

Optional at extra cost: Leather Pack (illustrated above right) comprising perforated leather seat facings, eight-way electrically adjustable and heated front seats, dual-zone electronic climate control, electrically folding door mirrors and electro-chromatic anti-dazzle driver's door mirror.

**New VXR8.** VXR8 Onyx leather featuring performance front seats with eight-way electrical adjustment and lumbar support adjustment.

# NEED MORE VXR?



**Then check us out online.** To really immerse yourself in the VXR experience log-on and prepare to be blown away at: [www.vxr.co.uk](http://www.vxr.co.uk)



Scan this QR code with your smartphone for more information. Don't forget to download a QR reader from your app store first.

## Vauxhall Lifetime Warranty

We're so confident in Vauxhall quality and reliability that we are now able to offer a lifetime warranty. Available to the first owner of all new Vauxhall passenger cars, it's valid for the lifetime of the vehicle up to a maximum of 100,000 miles\*. In addition, our warranty also includes Vauxhall Assistance for 12 months from first registration and six years body panel anti-perforation warranty. Full details of Vauxhall's warranties including terms, conditions and exclusions can be obtained through any authorised Vauxhall retailer or go to: [www.vauxhall.co.uk/warranty](http://www.vauxhall.co.uk/warranty)

**LIFETIME**  
WARRANTY 100,000 MILE



Proud Sponsor of Home Nations Football



\*Vauxhall Lifetime Warranty covers lifetime ownership of first car owner, 100,000 mile limit, annual check required. The warranty excludes wear and tear and serviceable items and the vehicle must be serviced in accordance with the manufacturer's servicing schedule to continue the lifetime warranty. Terms and conditions apply. Offer available to all Vauxhall passenger cars (this offer does not apply to car-derived vans) from 1st August 2010.

Every effort has been made to ensure that the contents of this publication were accurate and up-to-date at the time of going to press (January 2014). Vauxhall vehicles are equipped with components manufactured by various General Motors operating units and outside suppliers. The Company reserves the right to alter specifications and withdraw products from sale without notice. Any such alterations will be notified to Vauxhall retailers at the earliest opportunity, please consult your local retailer for the latest information. The specifications detailed within this brochure are not necessarily applicable to alternative models such as Special Editions. Details of any such models will be contained in specific literature or found on the Vauxhall website. Please note that Vauxhall retailers are not the agents of General Motors UK Limited and are not authorised to bind the Company by any specific or implied undertaking or representation. It is advisable to ensure that your motor insurance policy provides adequate cover for additional fitted options and accessories. Please note accessories shown are for illustrative purposes only. As part of Vauxhall's policy of environmental care, this brochure is printed on paper manufactured using Elemental Chlorine Free pulps from specially farmed, sustainable timber resources. All rights reserved. No part of this publication may be reproduced in any form or by any means, without the prior written permission of General Motors UK Limited.



**VAUXHALL**