

DACIA

# DACIA JOGGER



4th January 2024

1

## EXPLORE YOUR JOGGER

DISCOVER



2

## YOUR JOGGER FOR DAILY USE

DISCOVER



3

## EQUIPMENT AND TECHNICAL CHARACTERISTICS

DISCOVER



4

## THE DACIA SPIRIT: GOOD THINKING

DISCOVER



**BIGGER,  
COOLER,  
JOGGER**



# THE FAMILY CAR REINVENTED

Featuring the length of an estate, the spaciousness of an MPV and the robust style of an SUV, Dacia Jogger surprises by combining the best of these categories in a 7-seater family car. Versatile, elegant and affordable, Jogger fully embodies the Dacia spirit.



# DESIGNED FOR ADVENTURE

Elevated ground clearance marked wheel arches, and modular roof bars - Dacia Jogger boasts a robust design that adapts to all roads, designed for an action-packed family life.

Experience the adventure to the fullest with its EXTREME level, with an even more pronounced outdoor spirit: Copper Brown mirrors, alloy wheels, and a shark fin antenna coated in Glossy Black. A unique style signed by distinctive elements with topographical patterns for better identification.



In keeping with the times, the new model's Y-shaped brand light confirms its kinship with the new Dacia generation. The LED dipped headlights provide more intense lighting at night. At the rear, the vertical positioning of the lights broadens the tailgate opening, optimizing boot access.



**Alloy wheels and topographical pattern stickers**



**Copper-Brown door mirror shells**



**Copper-Brown Dacia logo on the tailgate**



## MUCH MORE THAN FUNCTIONAL

Interior design is as functional as it is comfortable. The wide dashboard accentuates the impression of space. A textile strip running across the dashboard\* provides a clean, uncluttered look that makes it easier to read the instrument panel and the multimedia screen above. The lower area provides easy access to the air conditioning and driver assistance system controls. The rear boasts impressive versatility.

For a 100% elegant and dynamic style, opt for the new Extreme trim level. Featuring washable MicroCloud fabric with copper-brown topstitching. The Extreme also features copper-brown front door molding, rear view camera, climate control, hands-free card, rubber floor mat and door sill with topographical patterns.

To extend the experience, go off the beaten track thanks to the Extended Grip Function which improves driveability.

\*depending on version.



**Extended Grip Button**

# TAKE ADVANTAGE OF JOGGER IN HYBRID VERSION

Once again, Dacia is in tune with the times and simplifies your daily life with Jogger available in hybrid motorization. A first for Dacia. The result? A family hybrid vehicle with 7 seats at an affordable price.

Dacia Jogger introduces on the hybrid version a new unique color: Shadow grey. And with its HYBRID identification at the rear, you assert your eco-smart choice.



On board, the atmosphere and technologies make your journey pleasant: automatic gearbox for easy and smooth driving, 7" colour instrument cluster, high central console with armrest and electric parking brake. With Jogger HYBRID 140, enjoy innovative equipment and optimized comfort.



**Multimode gearbox**



**7" Colour cluster with driving mode information**



# IN HYBRID, DISCOVER MORE FREEDOM

Forget about the connections while enjoying the benefits of electric thanks to the hybrid that recharges while driving. The technology of Dacia Jogger HYBRID 140 combines the dynamism of a thermal engine with that of an electric engine. Drive in urban areas in electric mode up to 80% of the time and achieve up to 30% fuel savings\*.

In addition to reduced CO<sub>2</sub> emissions, you will also benefit from restricted usage and maintenance costs. The multimode gearbox offers intelligent management of the two engines for powerful, smooth and quieter driving. Hybrid is simple with Dacia.

\* Depending on driving conditions.

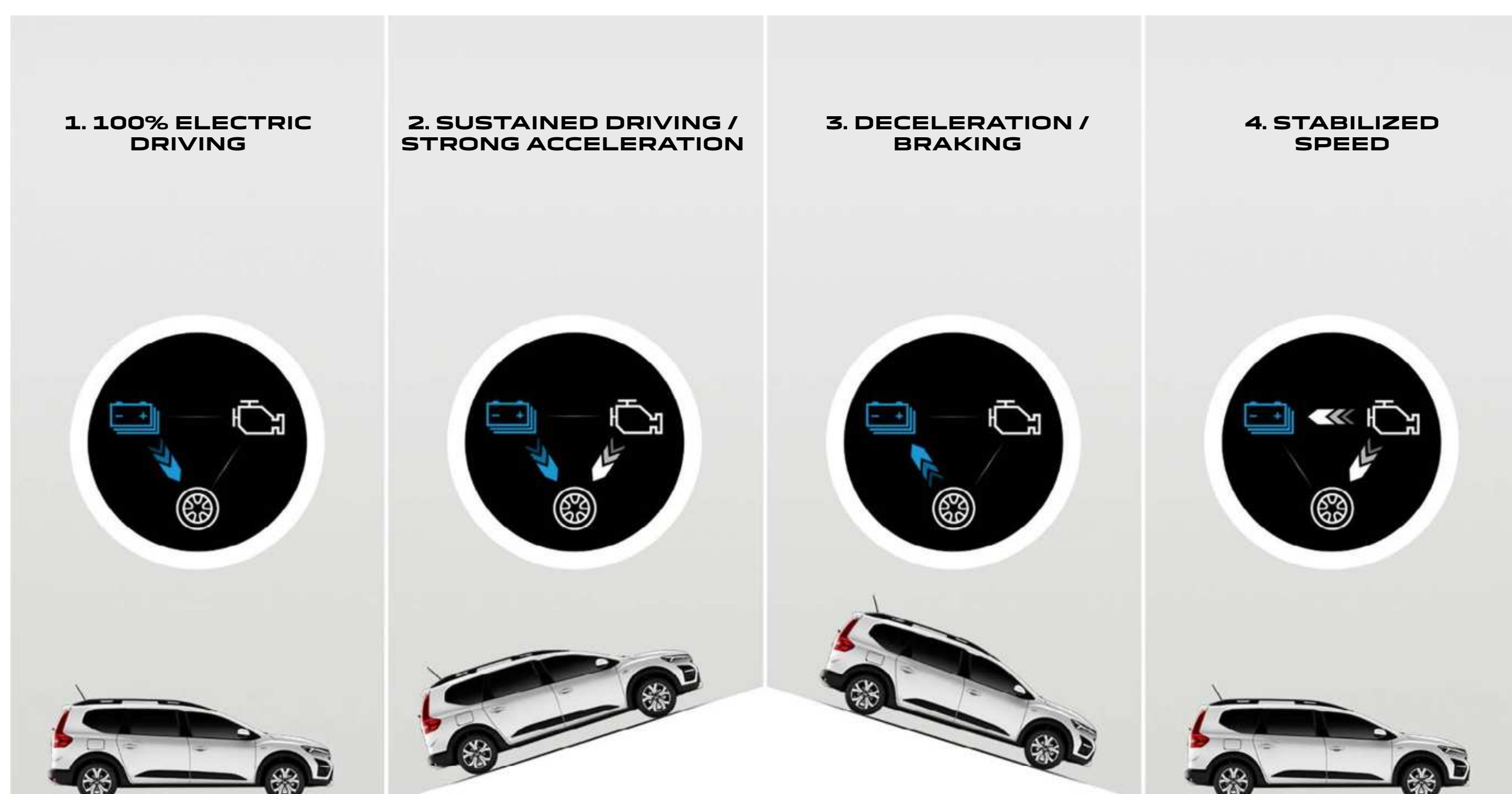

1. 100% electric driving: only the electric motor drives the wheels.
2. Sustained driving / strong acceleration: the thermal and electric motors operate simultaneously.
3. Deceleration / braking: the electric motor recharges the battery.
4. Stabilized speed: the thermal engine operates at its optimal speed to drive the wheels and recharge the battery.

[BUILD YOURS](#)

[MENU](#)

# ENJOY ENHANCED TRAVEL

More space and more versatility thanks to a unique approach to spaciousness, with 23 liters of useful storage areas for everyday use and multiple configurations to meet all your needs. Three multimedia equipment packages and latest-generation driver assistance system.



# COMFORT MULTIPLIED BY 7

Dacia Jogger embraces the whole family. It takes everyone's needs into account, offering the same level of comfort in all rows. The sculpted seats – adjustable at the front – promise fatigue-free travel for all seven occupants. Jogger also stands apart through well thought-out details and spaciousness.



In the second row, there are tray tables\* with cup holders and practical Isofix attachments for child seats. The third row offers record accessibility, with two individual seats with armrests providing uncompromising accommodation for two adults with generous legroom. Storage spaces are distributed throughout the passenger compartment to the benefit of all passengers. Dacia Jogger adds a new dimension to your on-board experience.

\* Depending on version.



**Sliding tray tables at the rear**



## RECORD MODULARITY

Dacia Jogger as a versatile car that offers a unique volume and versatility. The third-row rear seats are removable, the 3-seater bench is foldable 1/3-2/3 in the second row, and multiple configurations are possible in 2, 3, 4, 5, 6 or 7 seats according to your needs. A true Swiss Army knife!

On the trunk side, enjoy a volume of up to 2,094 liters\* and a loading height that can accommodate everything you take with you. And in its hybrid version, all habitability and modularity are preserved thanks to the clever placement of the battery under the floor.

Trust Jogger to simplify your urban or distant adventures.

\* 1819 dm<sup>3</sup> in VDA standard.

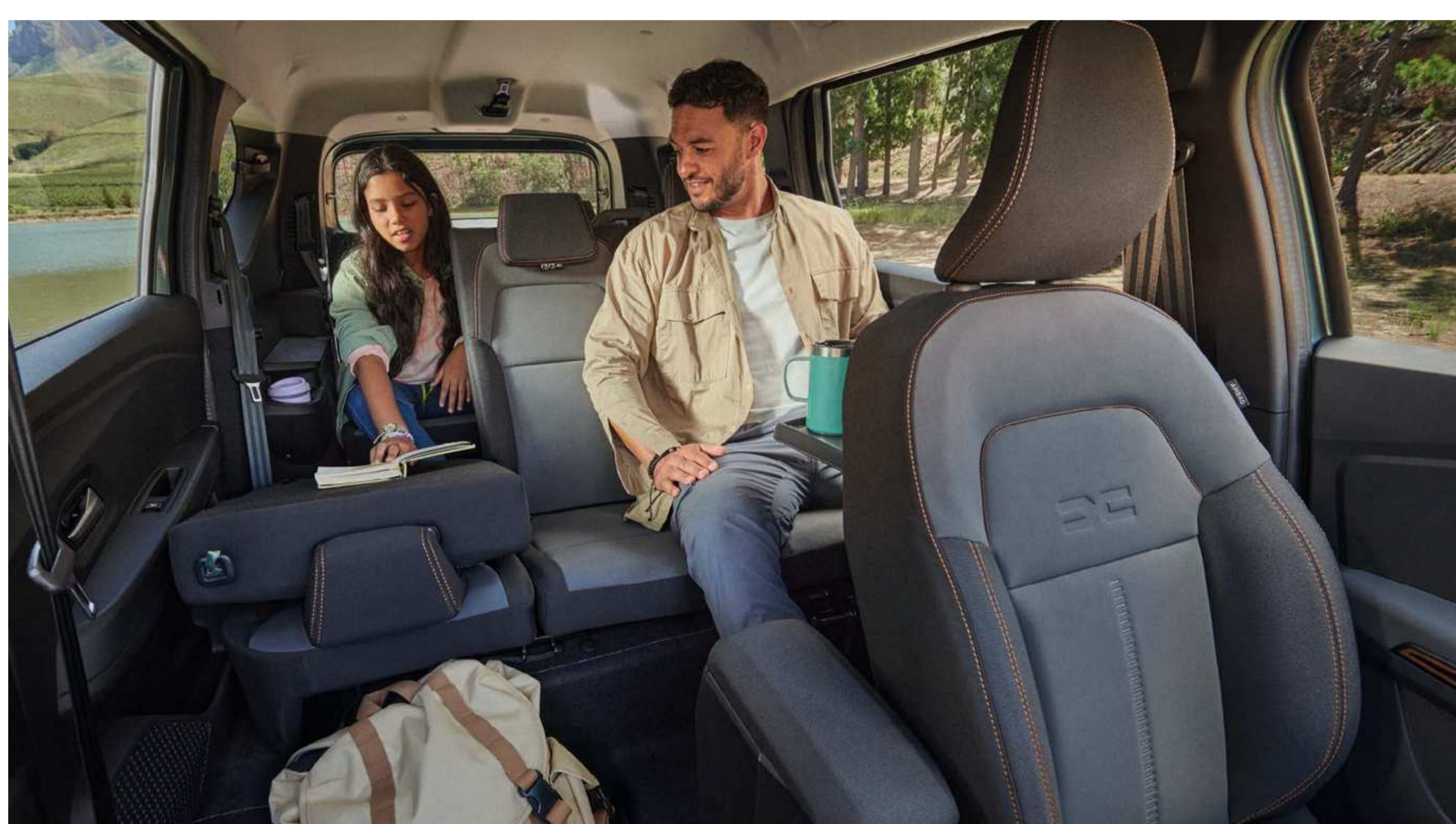

**As spacious and with same options of modularity as the other versions**

# ESCAPE INTO THE NIGHT

Get closer to nature with the Sleep pack, which is part of our Dacia InNature offer. Consisting of a 3-in-1 box, this pack includes a fold-out bed that is easy to install. In less than two minutes, turn your Dacia Jogger into a bedroom for two.



Get a good night's sleep on a 190x130cm mattress. Blackout blinds provide privacy as well as darkness. Whether the bed is folded out or not, the 220-litre storage compartment remains unaffected. Having a picnic is easy thanks to the removable rear shelf. Do you need a more spacious base camp? An external tent can be connected to Jogger when the trunk is open. Discover a new form of adventure. The Sleep pack is compatible with all versions of Jogger.



**Opaque blackout blinds**



**Smart tent that can be connected to the Jogger**



## SELECT YOUR MULTIMEDIA PREFERENCES

Connect according to your needs and priorities. Dacia Jogger is available with three comprehensive multimedia offerings – the choice is yours. Benefit from the ingenious smartphone-controlled Media Control built into the dashboard design, Media Display featuring an 8-inch touchscreen, and Media Nav with navigation. Radio, music, Bluetooth<sup>®</sup>, USB, telephone, navigation, voice recognition.

The system of your choice provides the essentials and more, right up to AndroidAuto™ and Apple CarPlay™ compatibility. Smartphone replication via USB cable is also available. You also get to enjoy 3D sound (Arkamys™ System) thanks to the 6 speakers distributed throughout the passenger compartment, depending on the version.

Android Auto™ is a Google Inc. brand.  
Apple CarPlay™ is an Apple Inc. brand.



**Media Control**



**Media Display**

# DRIVE IN COMPLETE SAFETY



Blind spot warning



Cruise control



Rear and front parking sensors

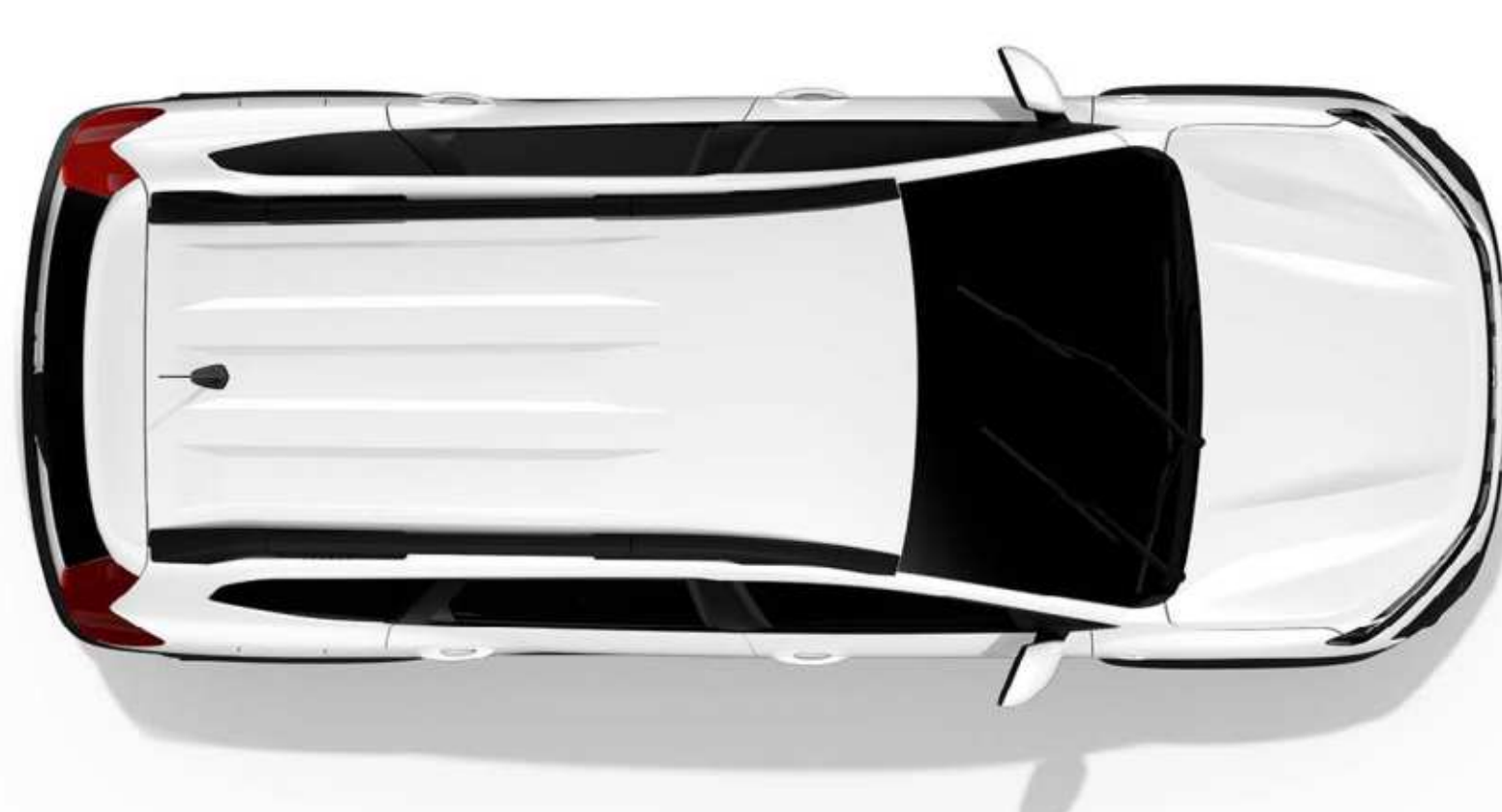

Automatic emergency braking



Hill start assist



Speed limiter

At Dacia, safety has always been at the heart of our concerns. Built on the latest platform designed for our vehicles, Dacia Jogger has a reinforced body structure and new-generation assistance systems that make driving easier. Drive with complete peace of mind.

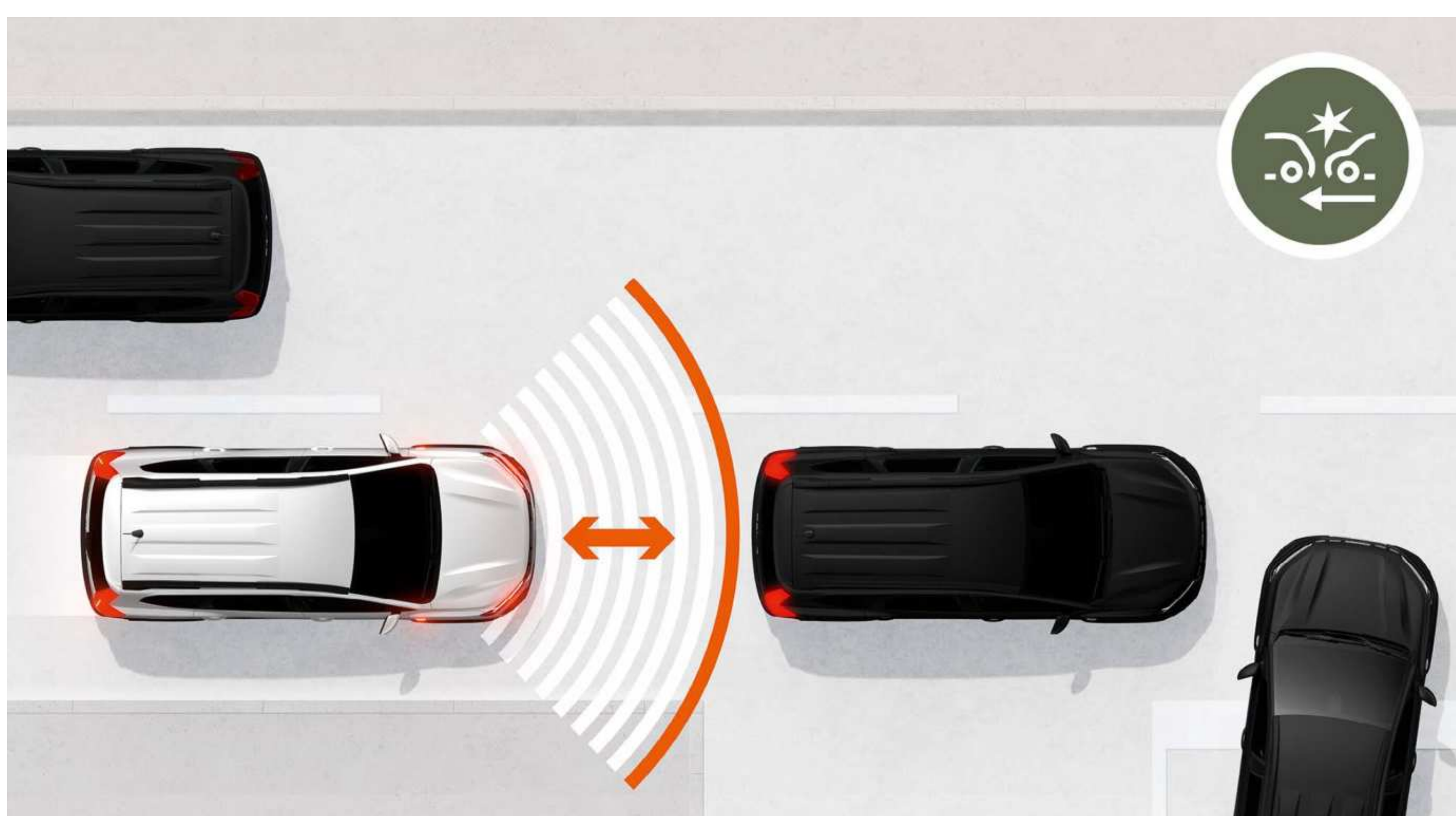

## AUTOMATIC EMERGENCY BRAKING

The system is active between 7 and 170 km/h and equipped with a front sensor that monitors the distance between your vehicle and the vehicle in front of you. If the vehicle in front slows down or stops, you are notified by a dual audio and visual warning. If your response is slow or insufficient, braking assistance is automatically applied.

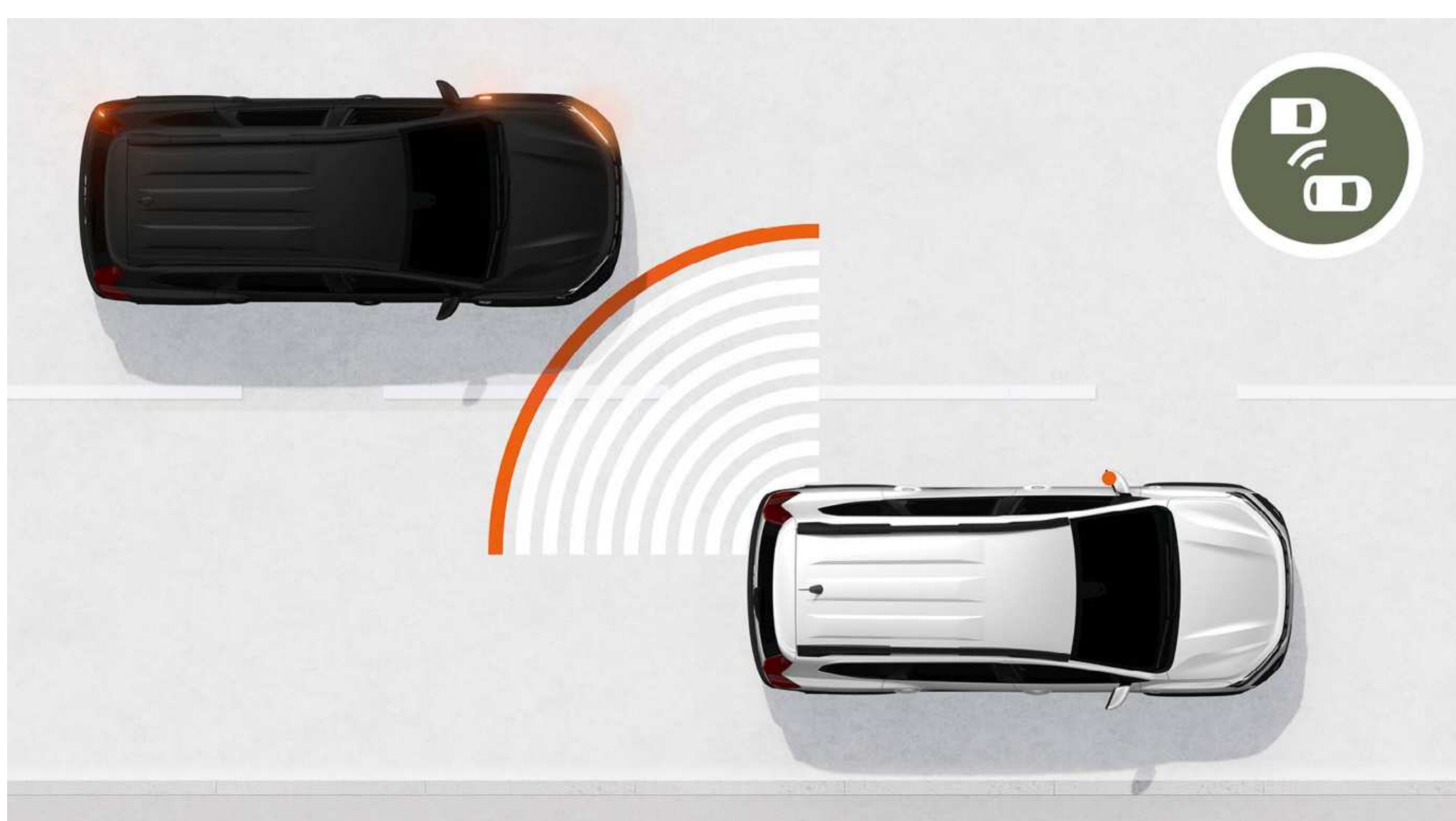

## BLIND SPOT WARNING

Active from 30 km/h, this system automatically alerts you, via warning lights in the door mirrors, of the presence of vehicles in your blind spot.

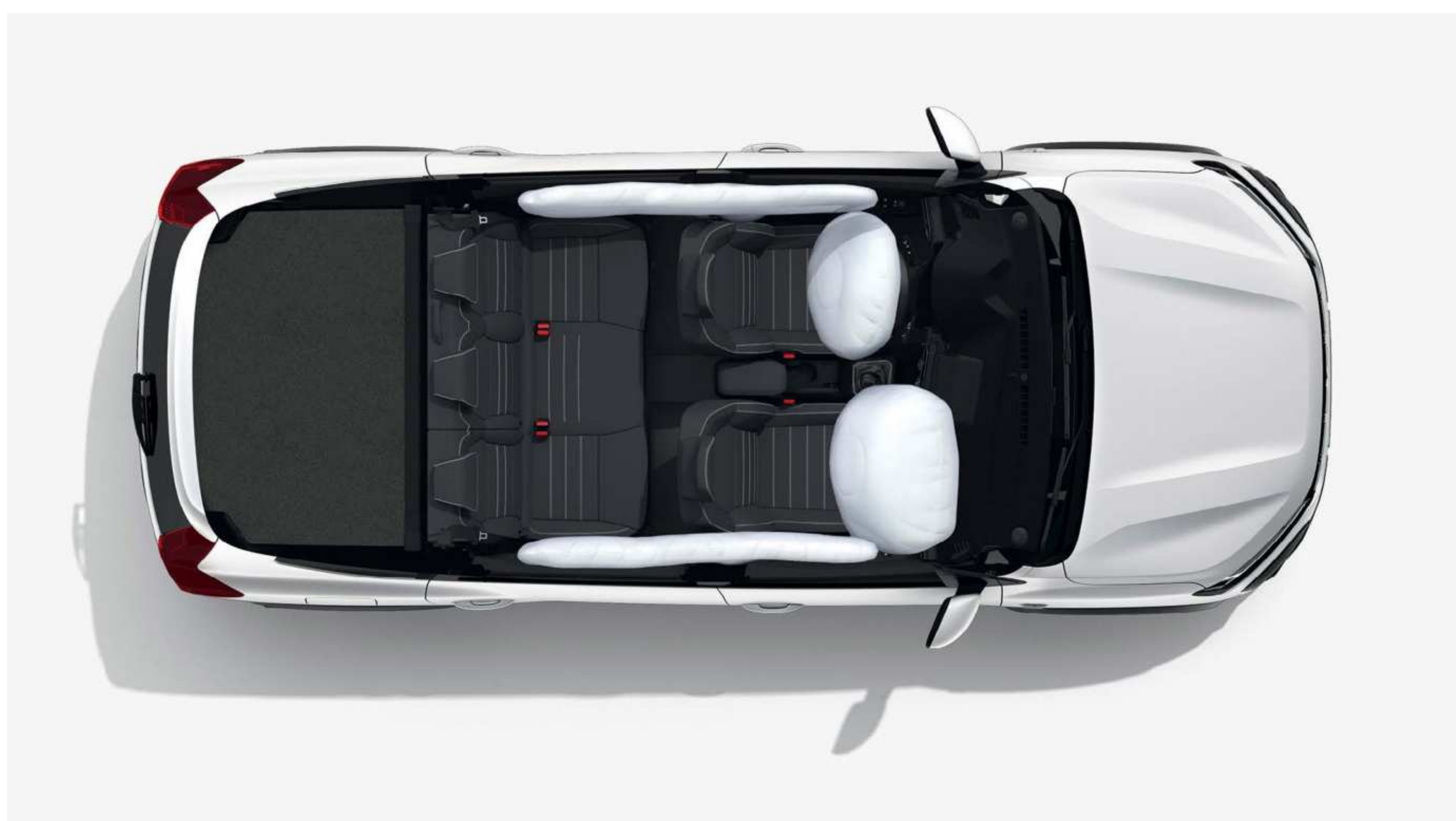

## AIRBAGS

Dacia's new-generation airbags are equipped with door pressure sensors and an accelerometer providing early detection of side collisions. The curtain and side airbags deploy more quickly for optimum protection of the abdomen, chest and head.

[BUILD YOURS](#)

[MENU](#)

# DISCOVER THE EQUIPMENT

COLOUR



AMBIANCES



ACCESSORIES



ENGINES



EQUIPMENT AND OPTIONS



PRICING









SERVICING



DIMENSIONS



# COLOUR

				
TERRACOTTA	CEDAR GREEN	GLACIER WHITE	PEARL BLACK	SHADOW GREY
				
DUSTY KHAKI	URBAN GREY			



TERRACOTTA<sup>(1)</sup>



CEDAR GREEN<sup>(1)\*</sup>



GLACIER WHITE<sup>(3)</sup>



PEARL BLACK<sup>(1)</sup>



SHADOW GREY<sup>(1)</sup>



DUSTY KHAKI<sup>(2)</sup>



URBAN GREY<sup>(2)</sup>

(1) Metallic paint. (2) Special paint. (3) Solid paint.  
\*Only available in Extreme finish.

# AMBIANCES

## ESSENTIAL

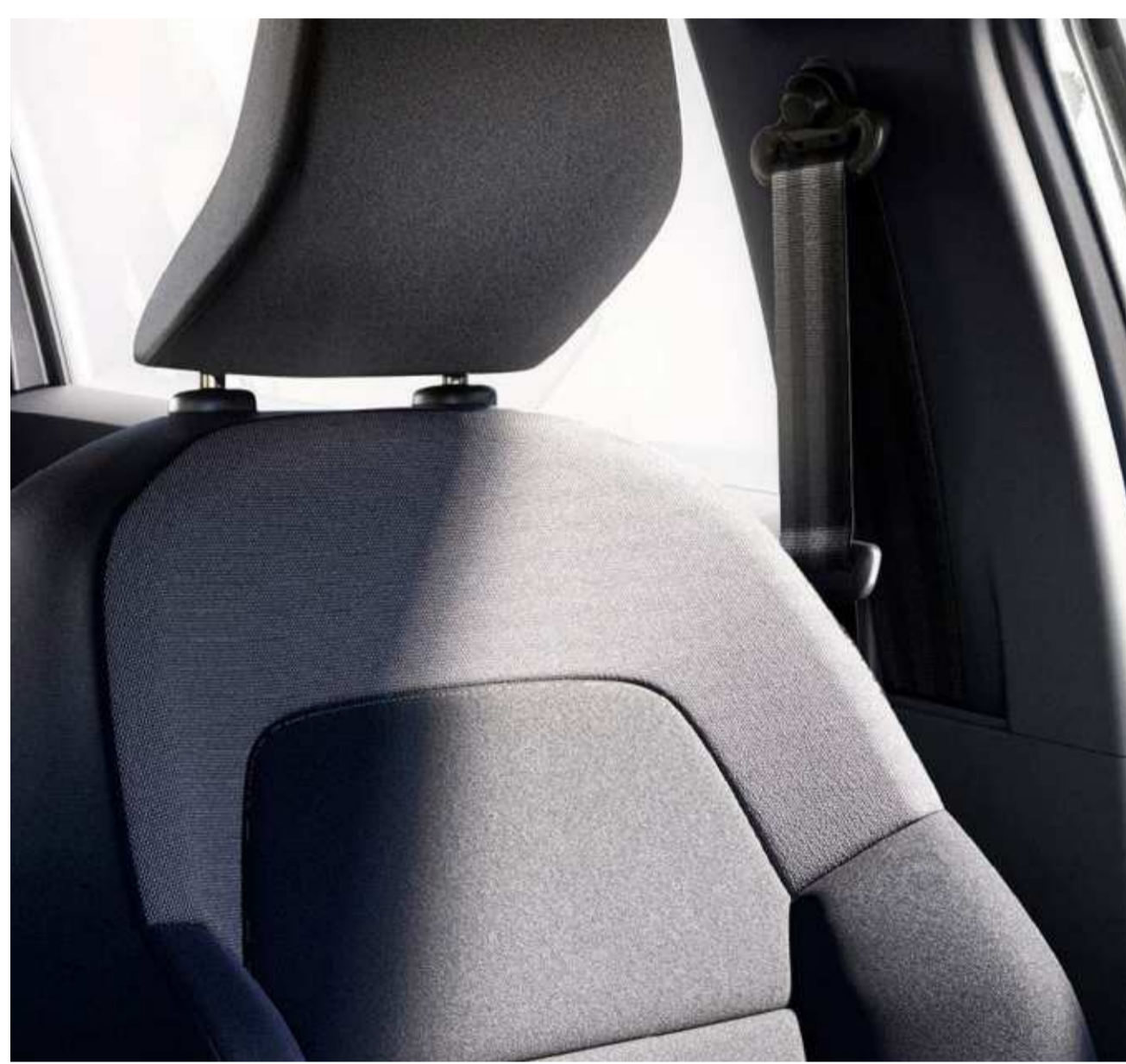

## MAIN EQUIPMENT ESSENTIAL

### EXTERIOR APPEARANCE

- New grille with new Dacia emblem and white trim
- LED light signature (DRL) & LED Automatic front low beam
- Black door handles - Black door mirrors
- Longitudinal roof bars
- Body colour front and rear bumpers
- 16" steel wheels
- Black front and rear skid plates

### INTERIOR APPEARANCE

- Fog grey air vent inserts
- Folding rear bench 1/3 & 2/3 (seat & back)
- Black door handles
- Essential Upholstery
- 3,5" digital instrument cluster
- Manual AC
- Depth adjustable steering wheel, cruise control, rear parking sensors

### DRIVING AND CONTROLS

- Electric power steering
- Hill start assist
- Stop & Start, Eco
- Speed limiter
- 180 kmh/ 112 mph Speed Limiter

### COMFORT

- Automatic door locking
- Remote door locking
- Front power windows
- Front USB port & 12V Plug
- Height adjustable steering wheel and height adjustable driver seat

### AUDIO

- Media Control: DAB Radio with switches on the steering wheel, display integrated into the trip computer, smartphone support integrated in the dashboard, 2 front speakers, Bluetooth® connection + Smartphone application Dacia Media Control

### OPTIONS

- Metallic paint
- Spare wheel

## EXPRESSION

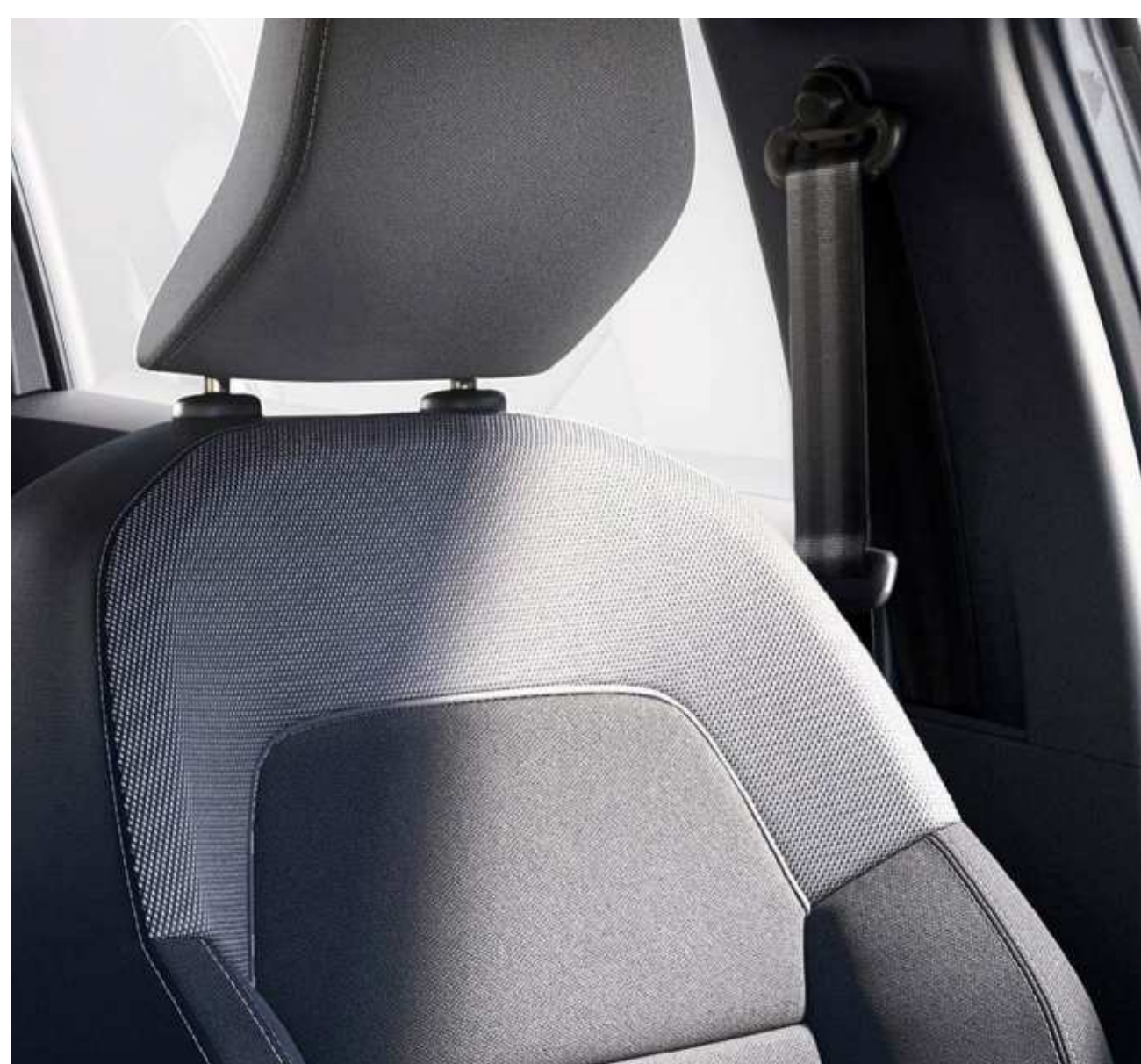

### MAIN EQUIPMENT EXPRESSION = ESSENTIAL +

#### EXTERIOR APPEARANCE

- Body colour door handles
- Electric adjustable door mirrors
- Modular roof bars
- Gloss black fog light surround
- 16" steel Flex wheel
- Tinted rear windows
- Megalith Grey front and rear skid plates

#### INTERIOR APPEARANCE

- White ventilation grilles
- Steel Grey interior door handles
- Fog Grey interior trim
- Specific Expression upholstery
- Fabric deco parts on the dashboard and front door-armrests
- High central console with armrest and storage space
- Luggage space cover
- 7 digital instrument cluster

#### DRIVING AND CONTROLS

- Cruise control
- Auto wiping
- Electric parking brake
- Hands-free card
- Auto AC

#### COMFORT

- Soft-feel height & depth adjustable steering wheel
- Electric rear windows - 12V Plug front & rear
- Height adjustable driver's seat
- Manual AC
- Front and rear parking sensor
- Blind spot warning
- Rear view camera

#### AUDIO

- Media Display: Android Auto™ and Apple CarPlay™ compatibility with smartphone replication via USB cable (DAB radio with 8" touch screen and 4 speakers)

#### OPTIONS

- Metallic paint
- Spare wheel\*

\* Not available on HYBRID 140.

Android Auto™ is a Google Inc. brand. Apple CarPlay™ is an Apple Inc. brand.

## EXTREME



### MAIN EQUIPMENT EXTREME = EXPRESSION +

#### EXTERIOR APPEARANCE

- Outdoor design with door stickers and side stickers with topographic patterns
- Copper-Brown Decoration: exterior door mirrors, Jogger logo on the roof bars, decorative front fog light molding
- Exterior door mirrors
- Copper-Brown Dacia logo on tailgate
- 16" Mahalia Black alloy wheels with Copper-Brown logo
- Gloss Black shark antenna
- Tilting rear quarter windows

#### INTERIOR APPEARANCE

- EXTREME specific upholstery textile TEP MicroCloud washable with Copper-Brown topstitching and embossing with the Dacia emblem
- Copper-Brown decoration: decorative molding on the door panels, ventilation grilles
- Textile TEP MicroCloud washable on the dashboard and front door armrests
- Front + rear rubber mats (including third row) and door sills with topographic patterns
- Steel Grey interior door handles
- Flight trays for 2<sup>nd</sup> row passengers

#### DRIVING AND CONTROLS

- Extended Grip Function

#### COMFORT

- Removable smartphone support
- 7" digital instrument cluster
- Front heated seats

#### AUDIO

- Media NAV: 8" touchscreen with integrated navigation, Western Europe or Eastern Europe maps + free updates for 3 years (twice a year), DAB radio, smartphone replication with Apple CarPlay™ and Android Auto™ replication, Bluetooth® & USB connection and 6 speakers

#### OPTIONS

- Metallic paint
- Spare wheel\*

\* Not available on HYBRID 140.

Android Auto™ is a Google Inc. brand. Apple CarPlay™ is an Apple Inc. brand.

# ACCESSORY PACKS

## STYLE PACK (ESSENTIAL & EXPRESSION)

£375 inc. fitting



Roof spoiler



Shark fin aerial



Illuminated door sills

## STYLE PACK (EXTREME)

£200 inc. fitting



Roof spoiler



Boot sill

## SIDE STEP PACK

£559 inc. fitting



Side steps

## PROTECTION PACK

£131 inc. fitting



Boot mat



Boot sill

## ROOF BOX PACK



400L roof box

£289

480L roof box

£349

## DASH CAM PACK

£422 inc. fitting



KENWOOD front dash cam



KENWOOD rear cam

## STORAGE PACK

£150

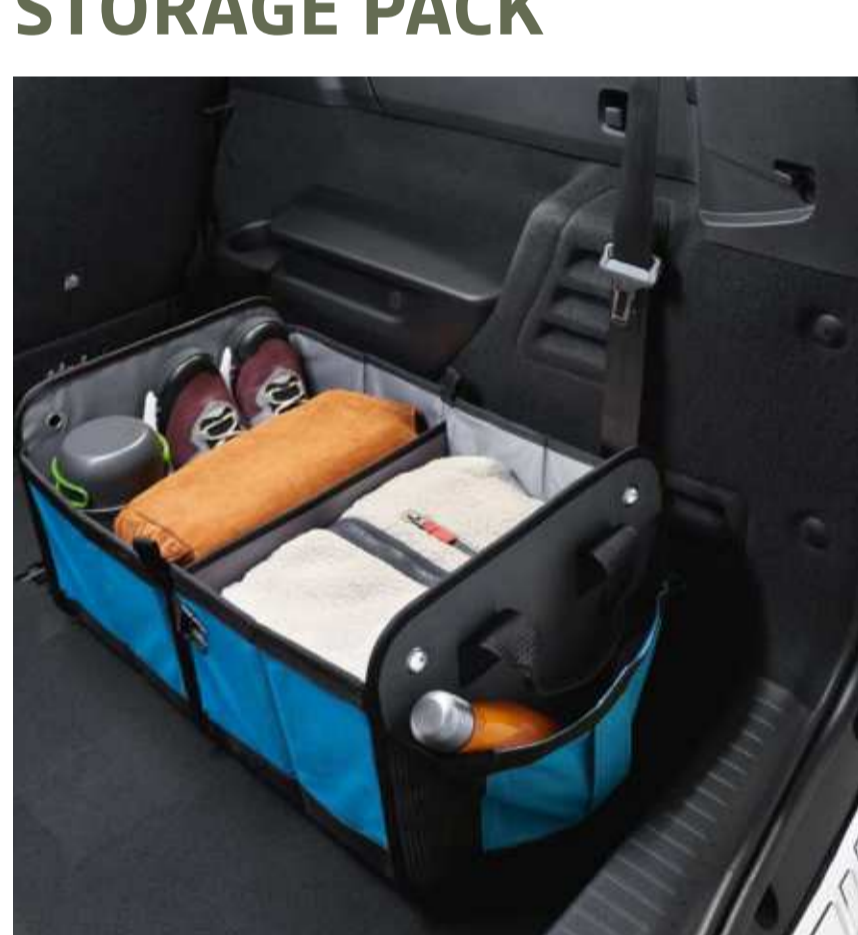

Boot storage box



Magnetic phone holder

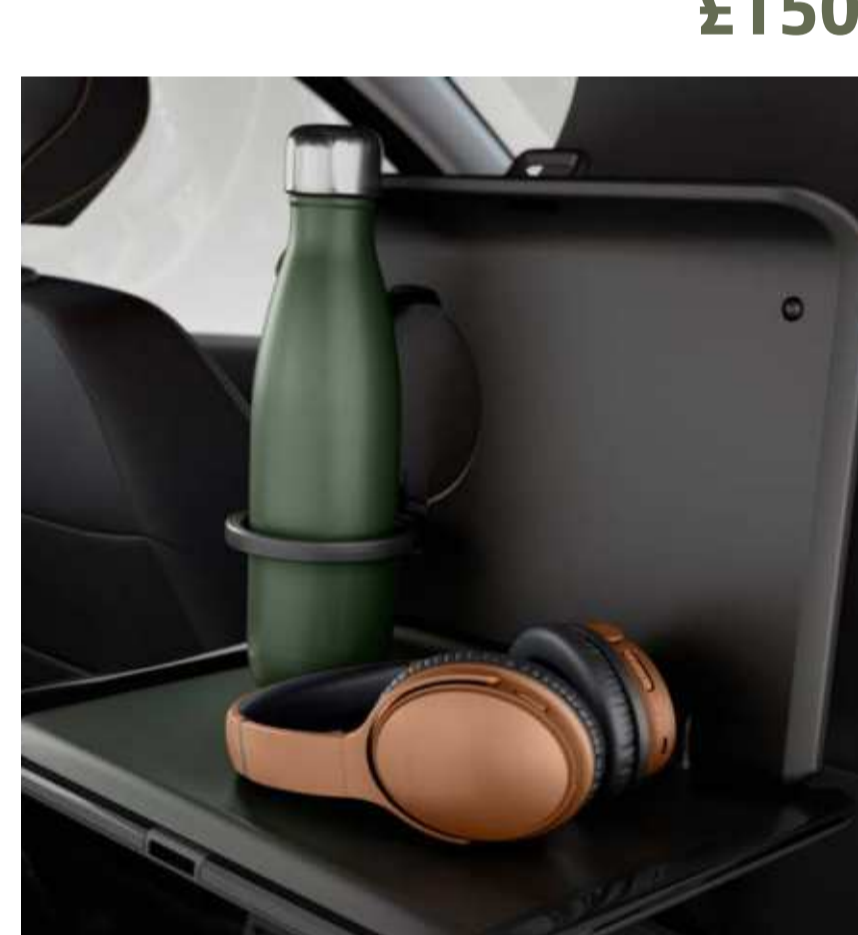

Rear tray table & fixings

Storage pack + available with 2 tray tables & fixings £252

## CYCLE PACK

£300



2 x adaptors for modular roof bars, 2 x bike carriers for roof

## PET PACK

£299 inc. fitting

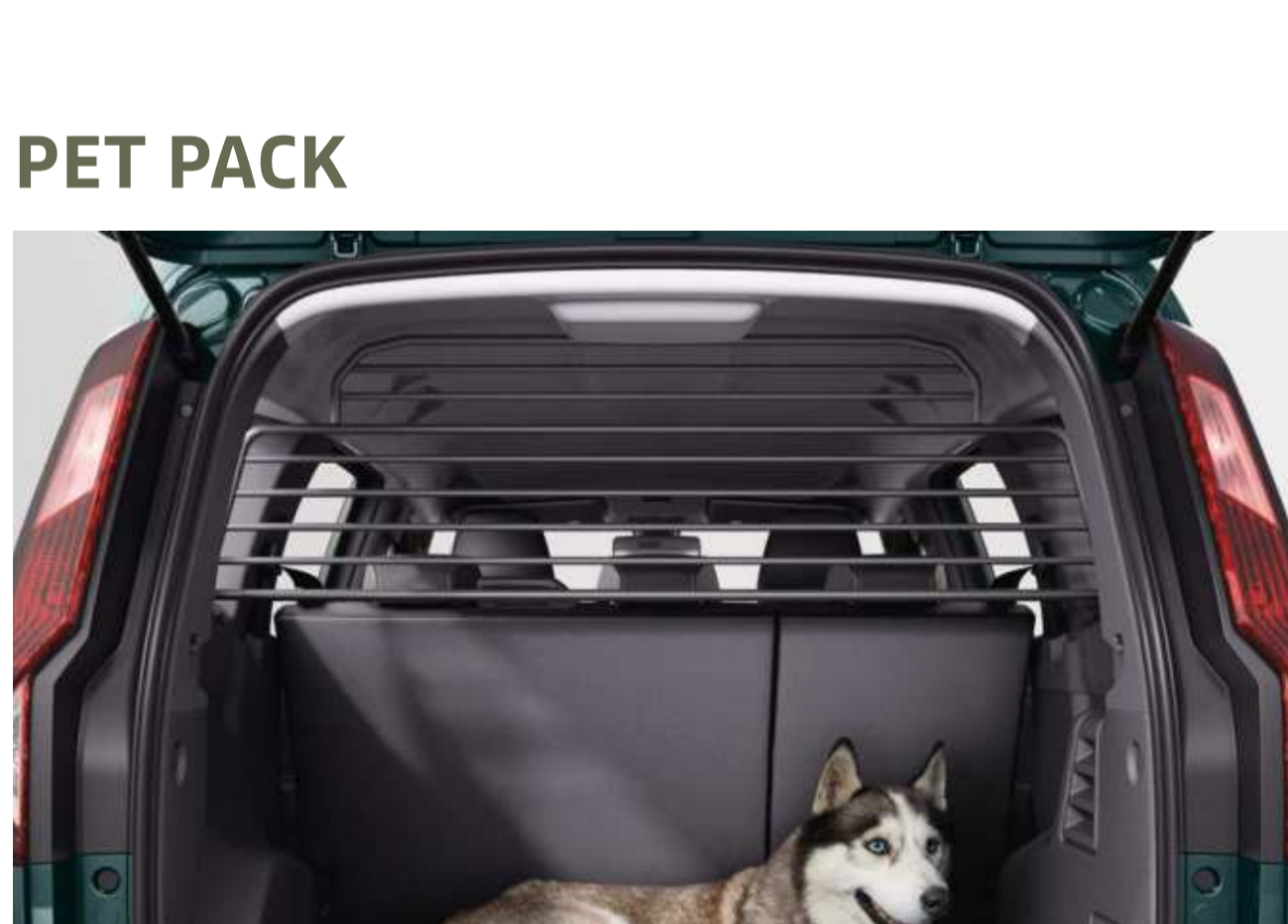

Separation grid

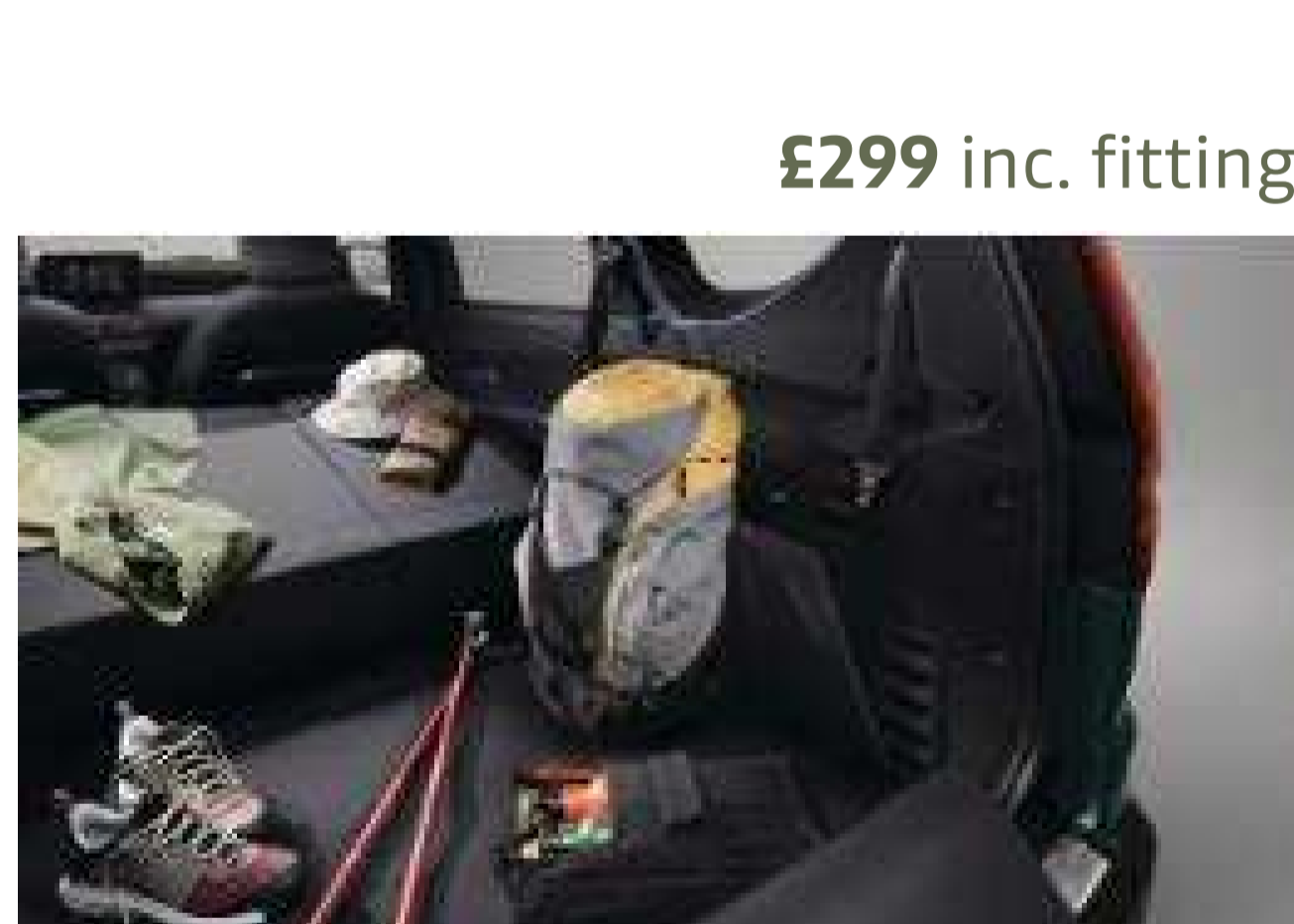

Modular boot liner

## TOW BAR PACK



Swan neck towbar 13 pin

Removable towbar 13 pin

£579 inc. fitting

£646 inc. fitting

## PREMIUM DELIVERY PACKS



Premium mats

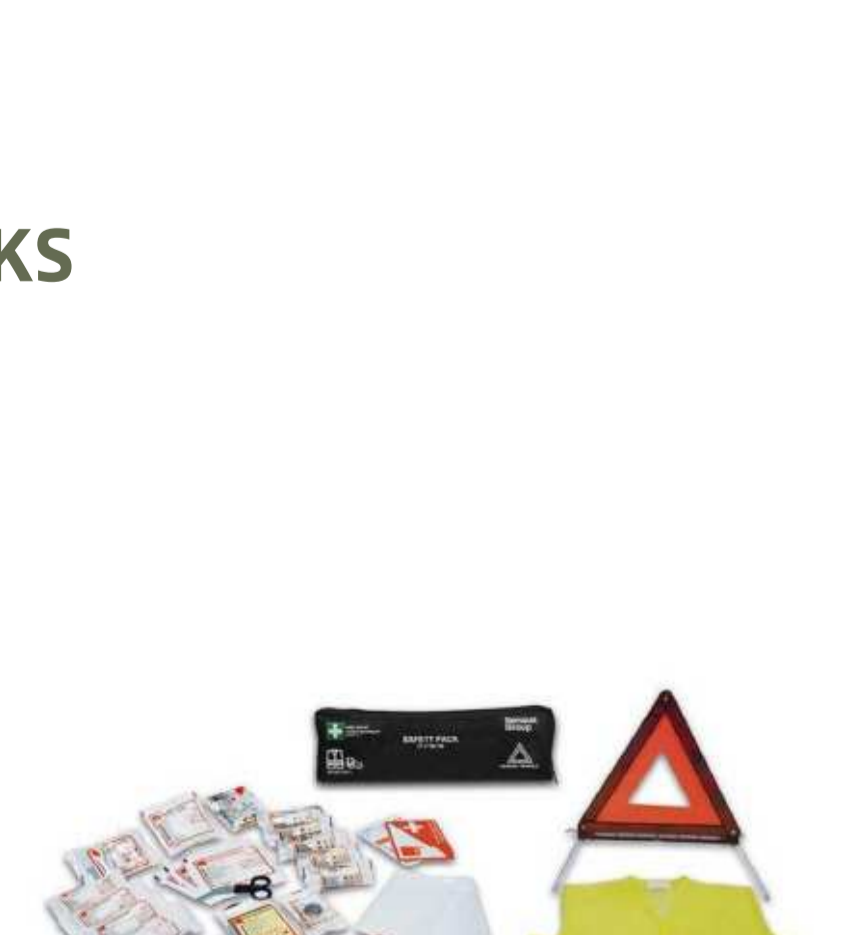

Safety kit



Rubber boot mat

## PREMIUM DELIVERY PACK

£95

Premium mats

Safety kit

## PREMIUM DELIVERY PACK+

£160

Premium mats

Safety kit

Rubber boot mat

All accessories purchased prior to vehicle registration come with a 3 year manufacturers warranty  
Accessories are fitted post production and may have an impact on WLTP fuel (actual) consumption and CO<sub>2</sub> figures

[DOWNLOAD ACCESSORIES BROCHURE](#)

# IN NATURE ACCESSORY PACKS

## SLEEP PACK +

£1,815



Blackout blinds, Seat storage bag, Sleep pack frame & mattress

## SLEEP PACK ULTIMATE

£2,165



Blackout blinds, Seat storage bag, Tailgate tent, Sleep pack frame & mattress

## PRIVACY PACK

£249



Blackout blinds, Seat storage bag

## CAMPING PACK

£599



Blackout blinds, Seat storage bag, Tailgate tent

All accessories purchased prior to vehicle registration come with a 3 year manufacturers warranty  
Accessories are fitted post production and may have an impact on WLTP fuel (actual) consumption and CO<sub>2</sub> figures

[DOWNLOAD ACCESSORIES BROCHURE](#)

# ENGINES

HYBRID 140

TCe 110

ENGINES			
Energy	Petrol	Electric	Petrol
Fiscal rating (CV) (France)	5		6
Max. power kW CEE (hp) at an engine speed of (rpm)	105 kW (140) at 5,600 rpm cumulative		81 kW/5,000-5,250 rpm
Max. torque Nm CEE (m.kg) at an engine speed of (rpm)	148 Nm at 3,400 tr/min + 205 Nm electric		200 Nm/2,900-3,500 rpm
Gearbox type	Automatic multimode		Manual
Type of injection	atmospheric indirect injection	-	gasoline direct injection
Capacity (cm <sup>3</sup> )	1 598	-	999
Number of cylinders/valves	4/16	-	3/12
Emission control standard	Euro6 D-final		

## BATTERIES

traction battery	Lithium-ion / 230V / 1,2 kWh	-
------------------	------------------------------	---

## CHASSIS AND STEERING

Tyre dimensions	205/60 R16 92H		
Steering - Turning circle, kerb to kerb (m)	11,7		
Front suspension	Pseudo McPherson with lower wishbone, spiral spring suspension with telescopic hydraulic shock absorbers and anti-roll bar		
Rear suspension	Semi-rigid axle with anti-roll bar spring suspension and telescopic hydraulic shock absorbers		

## PERFORMANCE

Maximum speed (mph)	104	108
0-62 mph (s)	10.0	11.2
Mid-range acceleration: 50 mph - 75 mph (s) in 4 <sup>th</sup>	8.8	8.9

## FUEL CONSUMPTION AND EMISSIONS<sup>(1)</sup>

Approval protocol	WLTP <sup>(2)</sup>	
Fuel tank capacity (l)	50	50
CO <sub>2</sub> emissions (g/km)	109	130
Consumption over a combined cycle mpg (l/100km)	57.7 (4.9)	48.7 (5.8)

## VOLUMES AND WEIGHTS

Minimum kerb weight	1,385	1,205
Maximum kerb weight	1,406	1,261
Gross train weight (GTW)	2,745	3,062
Maximum permissible laden weight (MPLW)	1,995	1,862
Max. braked towing weight	750	1,200

(1) Official consumption and emissions according to applicable regulations. (2) WLTP (Worldwide Harmonized Light Vehicle Test Procedures): this new protocol provides results much closer to those found in daily use compared to the NEDC protocol. CO<sub>2</sub> emissions are certified using a standard, regulated method. This method is identical for all manufacturers and enables vehicles to be compared.

[BUILD YOURS](#)

[MENU](#)

# EQUIPMENT & OPTIONS

ESSENTIAL    EXPRESSION    EXTREME

## EXTERIOR APPEARENCE

LED light signature (DRL) & LED front automatic low beam	•	•	•
New brand identity front grille	White	White	White
Dacia logo on the tailgate	White	White	Copper-Brown
Front and rear bumpers	Body coloured	Body coloured	Body coloured
Skid plates - front and rear	Black	Megalith Grey	Megalith Grey
Lower door protection sticker/ Additional «snorkel» type	- / -	Black / -	Specific Extreme design / •
Outside door handles	Black	Body coloured	Body coloured
Door mirrors	Black	Body coloured	Copper-Brown
Longitudinal roof bars	•	-	-
Modular longitudinal roof bars	-	•	•
Gloss Black shark antenna	-	-	•
16" Wheels	Hubcap «Miliana»	Flexwheel «Saria»	Glossy black «Mahalia»

## INTERIOR APPEARENCE

Airvents center	Black	White	Copper-Brown
Airvents surrounds	Fog Grey	Fog Grey	Fog Grey
Door handles	Black	Steel Grey	Steel Grey
Fabric deco parts on the dashboard and front door-armrests/ White deco part on front doors panels	- / -	Tissus / -	TEP / Copper
Folding rear bench 1/3 & 2/3	•	•	•
2 Independent Foldable & removable 3 <sup>rd</sup> row seats (specific to 7 seater variant)	•	•	•
Soft feel steering wheel and steel grey deco part	-	•	•
Floor mats with «Dacia» inscription & Boot protection	-	-	•
Luggage space cover	-	•	•

## ACTIVE & PASSIVE SAFETY

ABS (Anti-block Braking System) and AFU	•	•	•
Advanced Emergency Brake Assist System (AEBS) Interurbain	•	•	•
ESP (Electronic Stability Program) + HSA (Hill Start Assist)	•	•	•
Emergency call (E-call)	•	•	•
Driver's airbag/Front Passenger's airbag with deactivation	•/•	•/•	•/•
Side airbags (thorax & curtains (front + rear)	•	•	•
Rear seatbelts pyrotechnic with force limiter for side seats	•	•	•
Hill start assist	•	•	•
Rear parking sensors	•	•	•
Rear view camera	-	•	•
Front parking sensors + Blind Spot Warning	-	•	•
Electric Parking brake & central high armrest and storage inside	-	•/• (hybrid)	•/• (hybrid)
Keyless entry card	-	•	•
180 kmh / 112 mph speed limiter	•	•	•

## DRIVING AND CONTROLS

Tyre Pressure monitor	•	•	•
Inflating kit / Emergency spare wheel + jack (not included for LPG & HEV)	•/◦	•/◦	•/◦
Isofix fixation system for child seats on both rear side seats 2 <sup>nd</sup> row	•	•	•
Electric power steering	•	•	•
Stop & Start, ECO Mode	•	•	•
Trip computer: distance, average speed, fuel range, average fuel consumption (including LPG)	•	•	•
Speed limiter with audible warning/ Cruise Control	•	•/•	•/•
Extended Grip function	-	-	•

## VISIBILITY

Front fog lights	-	•	•
Electric Adjustable door mirrors	-	•	•

## COMFORT

Manual air conditioning	•	-	-
Automatic air conditioning	-	•	•
Automatic windscreen wipers	-	•	•
Remote door locking and automatic door locking when speeding	•	•	•
Front power windows	•	•	•
One touch power window for driver side & normal front passenger power window	-	•	•
Electric rear windows	-	•	•
Height adjustable steering wheel/depth adjustable steering wheel	•/-	•/•	•/•
Height & depth adjustable steering wheel + Cruise Control	•	•	•
USB port	•	•	•
12V Socket front/rear	•/-	•/•	•/•
Heated front seats	-	-	•
Rear parcel shelf	-	-	•
Tilting rear quarter glass	-	-	•

## AUDIO

Media Control : DAB Radio with switches on the steering wheel, display integrated in the trip computer, smartphone support integrated in the dashboard, 2 front speakers, Bluetooth® connection + Smartphone application Dacia Media Control	•	-	-
Media Display 8": DAB Radio + Smartphone replication via USB cable + Bluetooth® connection + 4 speakers + 8" Display	-	•	-
Media Nav <sup>(1)</sup> : MAP CARE navigation (Western or Eastern Europe maps + 6 free updates for 3 years), DAB radio, smartphone replication via USB cable, Bluetooth® connection, 6 speakers (4 speakers + 2 tweeters), 8" touch screen, 1 additional USB at the bottom of the central console	-	-	•

- : not available; • : available as standard; ◦ : available as an option. (1) compatible with Apple CarPlay™ and Android Auto™. Android Auto™ is a Google Inc. brand. Apple CarPlay™ is an Apple Inc. brand.

[BUILD YOURS](#)

[MENU](#)

# PRICING

	CO <sub>2</sub> G/KM WLTP	FUEL TYPE	COMBINED FUEL CONSUMPTION (MPG) - WLTP	BHP	BENEFIT IN KIND	VED YEAR 1	BASIC PRICE	VAT 20%	TOTAL RETAIL PRICE	ON THE ROAD PRICE*
<b>ESSENTIAL</b>										
TCe110 MY23	130	Petrol	48.7 (5.8)	110	31%	£210	£14,529.17	£2,905.83	£17,435.00	£18,295
<b>EXPRESSION</b>										
TCe110 MY23	130	Petrol	48.7 (5.8)	110	31%	£210	£15,612.50	£3,122.50	£18,735.00	£19,595
HEV 140 MY23	109	Petrol / Electric	56.5 (5)	140	27%	£175	£18,475.00	£3,695.00	£22,170.00	£22,995
<b>EXTREME</b>										
TCe110 MY23	130	Petrol	48.7 (5.8)	110	31%	£210	£16,445.83	£3,289.17	£19,735.00	£20,595
HEV 140 MY23	109	Petrol / Electric	56.5 (5)	140	27%	£175	£19,308.33	£3,861.67	£23,170.00	£23,995

\* "On the Road" price includes delivery to the dealer premises, number plates, 12 months government road fund license (depending on CO<sub>2</sub> emissions) and First Registration Fee at £55.

# OPTIONS

	ESSENTIAL	EXPRESSION	EXTREME	BASIC PRICE	VAT 20%	TOTAL RETAIL PRICE
Metallic & opaque paint	○	○	○	£541.67	£108.33	£650
Spare Wheel (excluding HYBRID 140 versions)	○	○	○	£250.00	£50.00	£300

# WE'VE GOT YOU COVERED

You might think our shockingly affordable prices mean our cars aren't made to last. Actually, the Dacia range is one tough cookie. To prove it, you get a 3-year\* warranty (or 60,000 miles, if you reach that first). This means we will replace any part which has been deemed by a Dacia approved dealer to be defective due to a manufacturing fault, free of charge. To keep the good times rolling, you can extend your warranty up to 7 years for a great price. We also give you a 2-year paintwork and 6-year anti-corrosion warranty, so you can kick back knowing that your Dacia will stay looking good-as-new for years to come.

## ROADSIDE ASSISTANCE

Although our cars are built for plain sailing, you can rely on us if you have a breakdown – 24/7 365, wherever you are in the UK or Northern Ireland. This offer also stands for the first 3 years/60,000 miles $\Delta$  after you buy your new Dacia.

## DACIA CAR INSURANCE 1

Dacia Insurance has been specifically created to provide superb protection for you and your car. Unlike most other UK insurers, in the event of an accident, your Dacia will be repaired at a Dacia Approved Bodyshop using only Dacia approved parts and approved repair methods. This maintains your Dacia's safety rating, protects its resale value and helps to maintain its Dacia warranty $\wedge$ . Dacia Insurance also offers a courtesy car for the duration of a repair at a Dacia Approved Bodyshop.

**Dacia car insurance: 0330 102 7795 [www.daciacarinsurance.co.uk](http://www.daciacarinsurance.co.uk)**

Lines are open Mon - Thurs 8.30am - 7pm, Fri 9am - 6pm, Sat 9am - 5pm

## SERVICING

Dacia Service Plans are the ultimate hassle free way to take care of your vehicle. Depending on the Service plan you purchase (see opposite grid) your servicing needs are covered and you benefit from;

- Inflation Proof Servicing – You know exactly what you'll pay and there are no hidden costs
- Peace of Mind – No matter where life takes you, we'll be there in over 5000 workshops across Europe
- Dacia Expertise & Quality – Our highly trained technicians know your Dacia inside out

The Dacia Service Plan contains Dacia services in-line with the manufacturer's service schedule, plus comes with a complimentary vehicle health check to ensure your Dacia is in the best condition possible.

SERVICE PLAN $\wedge$	Monthly payments with Dacia Finance**	Stand alone Contract
3 years / 30,000 miles Service Plan	£14.99 per month	£16.00
3 years / 48,000 miles Service Plan	£25.99 per month	£27.00
4 years / 48,000 miles Service Plan + 1 MOT	£21.99 per month	£22.00

EXTENDED WARRANTY	Total Retail Price
4 years / 60,000 miles $\dagger$	£165
5 years / 60,000 miles $\dagger$	£275
6 years / 60,000 miles $\dagger$	£415
4 years / 100,000 miles $\dagger$	£490
5 years / 100,000 miles $\dagger$	£565
6 years / 100,000 miles $\dagger$	£715

Dacia Extended warranty ends when you reach the age or mileage limit (whichever comes first). For full Warranty Terms and Conditions visit [www.dacia.co.uk/warranty-and-assistance/assistance](http://www.dacia.co.uk/warranty-and-assistance/assistance)

## SERVICE INTERVALS $\diamond$

Annual servicing **OR** servicing at 18,000 miles (whichever comes first)

Service Schedule $\diamond$	Year 1	Year 2	Year 3	Year 4	Year 5	Year 6
	Change Cabin Filter	Change Oil + Oil Filter	Change Cabin filter + Brake Fluid	Change Oil + Oil filter + Air filter (36k miles) + Spark Plugs (36k miles)	Change Cabin filter + Coolant (90k miles) + 12v battery (Hybrid)	Change Oil + Oil Filter + Brake Fluid + Accessory Belt (90k miles)

\*Dacia warranty ends when you reach the age or mileage limit (whichever comes first), from date of registration. Subject to status, terms and conditions apply. For full Dacia Extended Warranty Terms and Conditions visit [www.dacia.co.uk/warranty-and-assistance/warranty](http://www.dacia.co.uk/warranty-and-assistance/warranty)

$\Delta$ Roadside assistance for the first 3 year / 60,000 miles, which ever is reached first, from date of registration. For full Terms and Conditions visit [www.dacia.co.uk/warranty-and-assistance/assistance](http://www.dacia.co.uk/warranty-and-assistance/assistance)

$\dagger$  Dacia Extended warranties are available to purchase from first date of registration up to end of manufacturer warranty. For full Dacia Extended Warranty Terms and Conditions visit [www.dacia.co.uk/warranty-and-assistance/warranty](http://www.dacia.co.uk/warranty-and-assistance/warranty)

The monthly Service plan offer is available at point of signing a finance agreement for vehicle purchased under HP and PCP finance agreement provided by Dacia Finance Ltd. (Not available on cash purchases).

$\wedge$  The Service plan offer is available for eligible retail vehicles only and valid at participating dealers only. Vehicles must be ordered between 2 January to 4 April and registered by 30 June 2024. The Dacia Service plan covers the manufacturer's minimum maintenance programme requirements for the term of the Service plan purchased (refer to the Warranty and Service sheet in the Handover Document wallet for details). The plan ends when you reach the age or mileage limit (whichever comes first). Services must be carried out in line with the manufacturer's minimum maintenance programme requirements and servicing intervals within +/- 1 month or 1,000 miles of the service interval and can only be carried out at a Dacia Approved outlet. Service plans do not cover wear and tear items such as (but not limited to) tyres, wiper blades or brakes. For Service plan full Terms & Conditions visit [www.dacia.co.uk/services-and-finance/service-plan](http://www.dacia.co.uk/services-and-finance/service-plan). Cannot be part exchanged, refunded or transferred.

$\diamond$  The service schedule and intervals are specific to the version and derivative of vehicle. Check with your Dacia retailer to confirm the service schedule / intervals as the above is an indicative guideline.

\*\*36 or 48 monthly payments options are only available at point of signing a finance agreement provided by Dacia Finance, Rivers Office Park, Denham Way, Rickmansworth, WD3 9YS. Guarantees and indemnities may be required. You must be a UK resident (excluding the Channel Islands) and over 18 to apply for finance. Terms and conditions apply.

1 Dacia Insurance is arranged and administered by Verex Insurance Services Ltd, which is registered in England and Wales No. 05686831 at Batchworth House, Church Street, Rickmansworth, Herts, WD3 1JE and authorised and regulated by the Financial Conduct Authority, No. 487185. Verex Insurance Services Ltd arranges policies from a panel of insurers, details are available on request.

$\wedge$ If your insurer uses non-approved parts which subsequently fail, they may not be covered under your manufacturer's warranty.

# DIMENSIONS

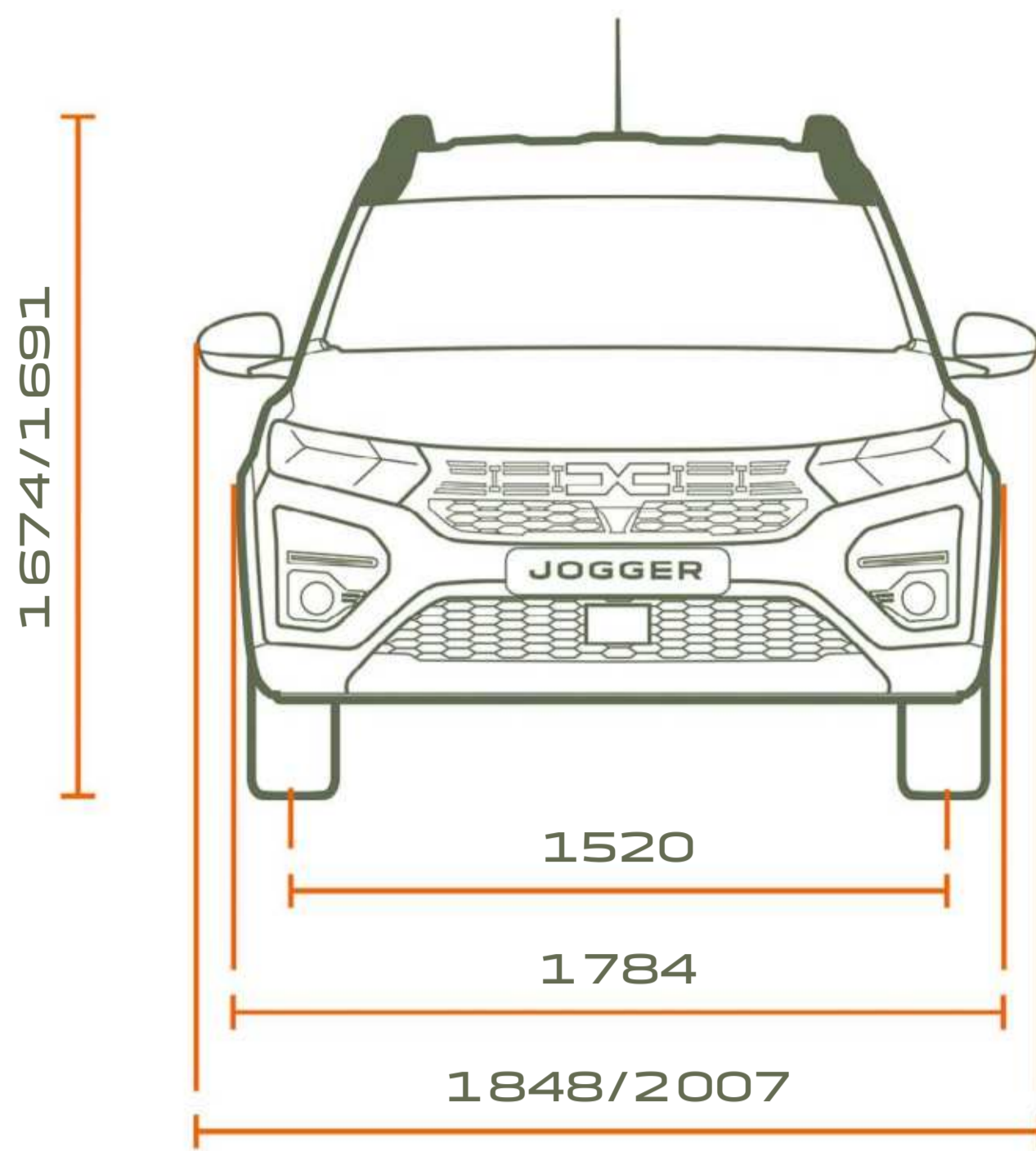

**FRONT VIEW**

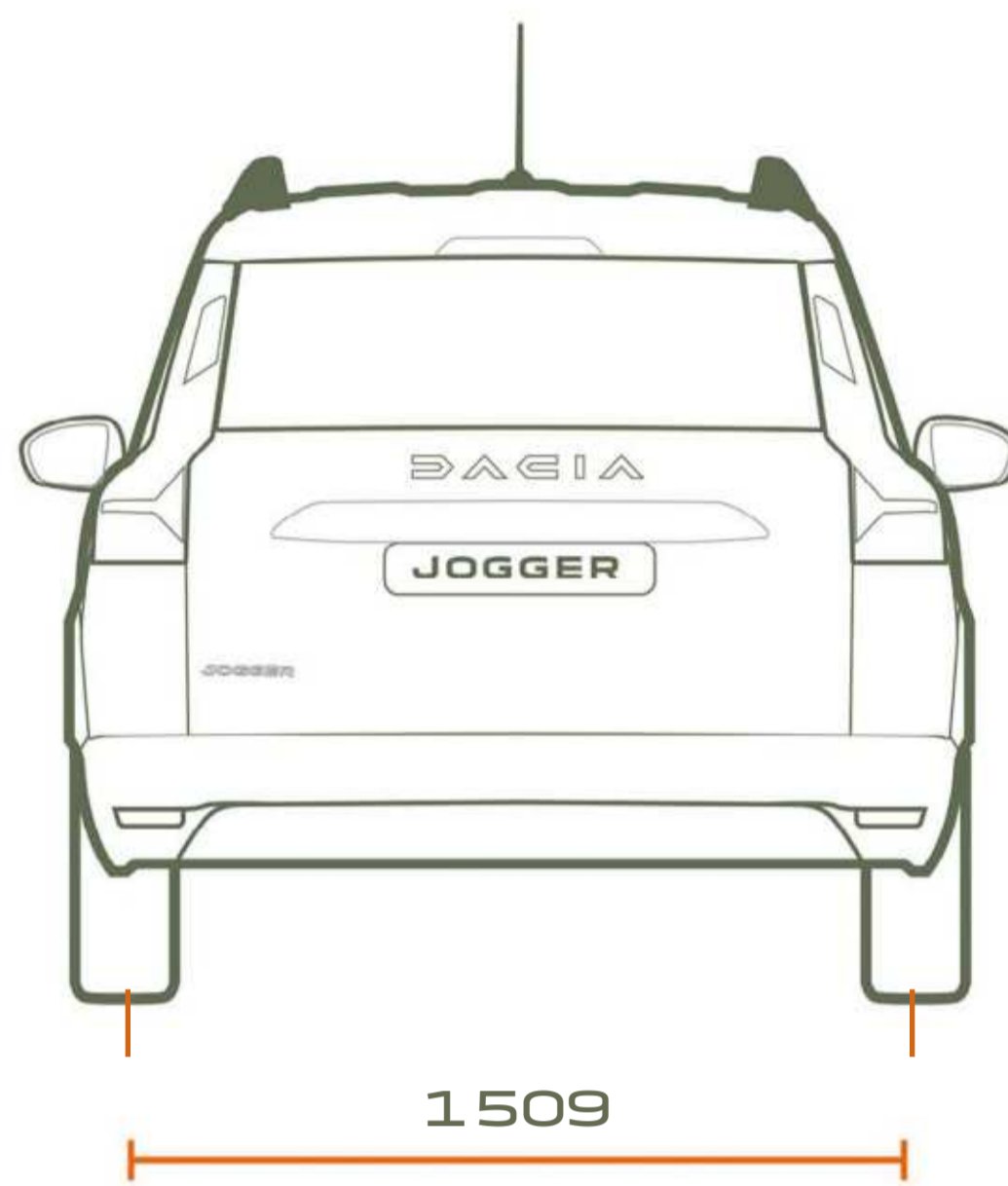

**REAR VIEW**

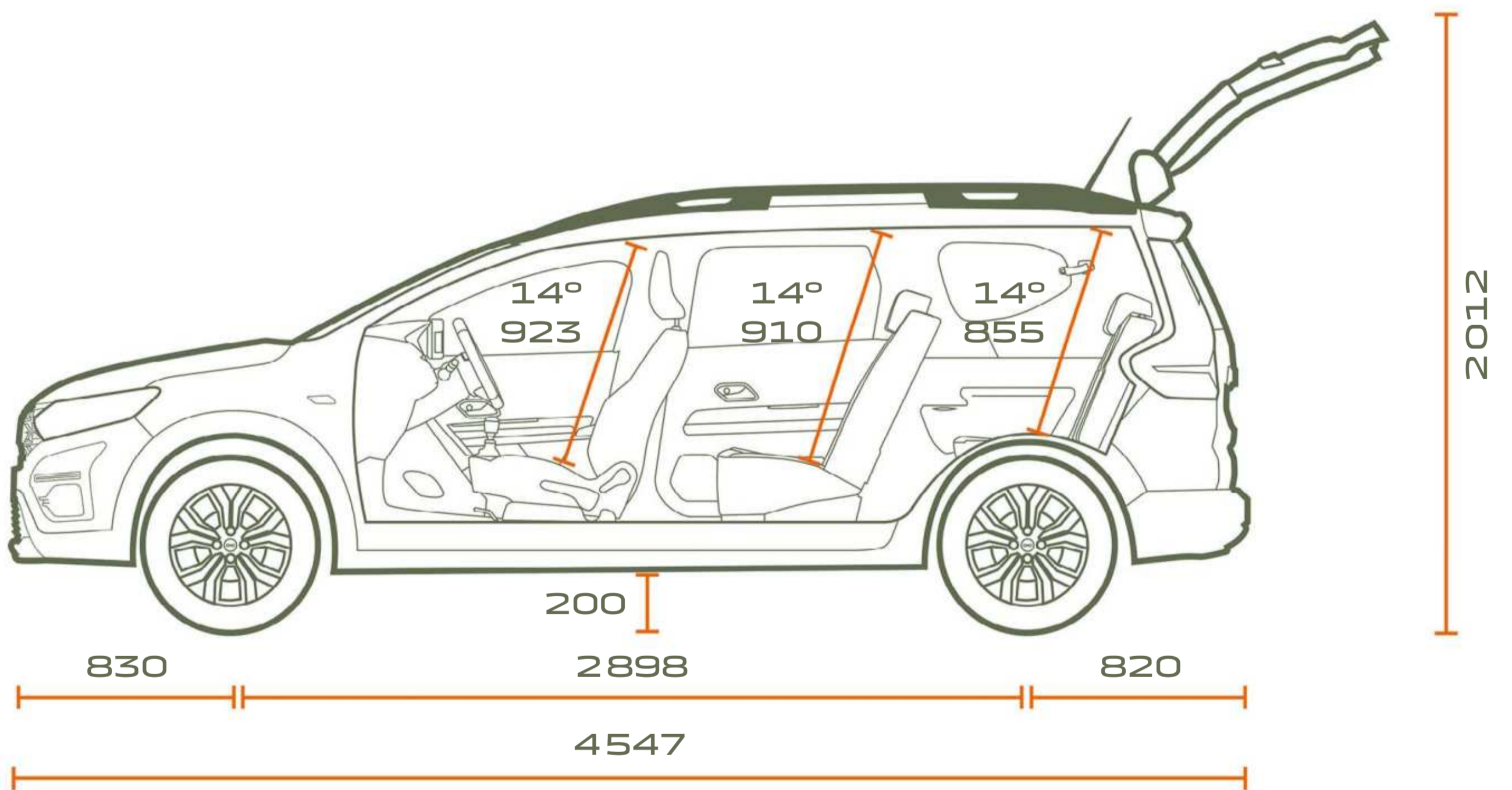

**SIDE VIEW**

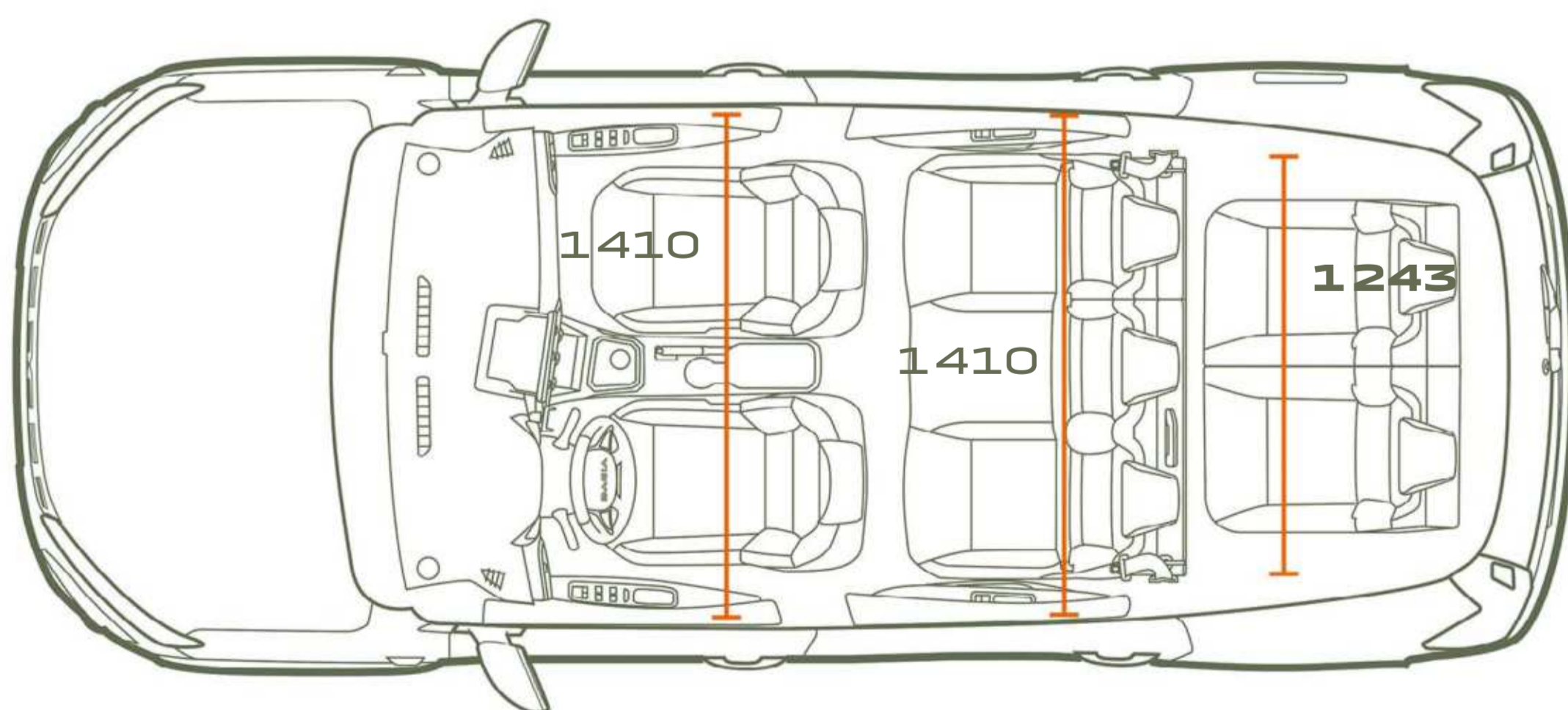

**TOP VIEW**

BOOT VOLUME - (IN DM <sup>3</sup> - VDA STANDARD / LITRES)	7 SEATS
Minimum boot volume – (ISO 3832 standard)	160/212
Maximum boot volume – (ISO 3832 standard)	1,807/2,085
Row 2 in place and row 3 folded down	565/699
Row 2 in place and row 3 removed	696/820

# AN INCREDIBLE SUCCESS STORY

At Dacia, we offer practical and robust vehicles at the best price. Our models have a distinctive style without unnecessary frills, equipped with the most reliable and approved technologies, all at an unbeatable price. In just fifteen years, we have changed the game and disrupted the automotive market.



# TO GO FURTHER

[CLICK AND CONFIGURE](#)

[BOOK A TEST DRIVE](#)

[FIND YOUR DEALERSHIP](#)



Access the DACIA  
Facebook account



Access the DACIA  
Twitter account



Access the DACIA  
Instagram account

The contents of this brochure were accurate and up-to-date at the time of publication. This document was produced based on pre-series or prototype vehicles. As part of its policy of continuous product improvement, Dacia reserves the right, at any time, to make changes to the specifications and vehicles and accessories described and illustrated. These modifications are notified to Dacia dealers as soon as possible. Depending on the country of sale, versions may differ, and some equipment may not be available (as standard, optional, or accessory). Please consult your Dacia representative for the most up-to-date information. Due to the limitations of printing, the colors shown in this document may slightly differ from the actual paint colors or interior trim materials. All rights reserved. Reproduction, in whole or in part, of this brochure in any form or by any means is prohibited without the prior written authorization of Dacia.

Dacia recommends 

PUBLICIS – PHOTO CREDITS : BAM (Ben & Martin) ; A. Bernier ; Getty images ; Shutterstock ; © RENAULT MARKETING 3D-COMMERCE – JANUARY 2024